

ELECTRICAL ENGINEERING TEXTS

PRINCIPLES
OF
DIRECT CURRENT MACHINES

BY

ALEXANDER S. LANGSDORF, M. M. E.

PROFESSOR OF ELECTRICAL ENGINEERING AND DEAN OF THE SCHOOLS OF ENGINEERING
AND ARCHITECTURE, WASHINGTON UNIVERSITY; FELLOW, AMERICAN
INSTITUTE OF ELECTRICAL ENGINEERS

FIRST EDITION

McGRAW-HILL BOOK COMPANY, Inc.

239 WEST 39TH STREET, NEW YORK

6 BOUVERIE STREET, LONDON, E. C.

1915

TK2611
L3

COPYRIGHT, 1915, BY THE
MCGRAW-HILL BOOK COMPANY, INC.

TO THE
ASSOCIATION

Dedicated
TO MY MOTHER
SARAH SUSS LANGSDORF

321585



PREFACE

This book has been prepared with the object of placing before junior and senior students of electrical engineering a reasonably complete treatment of the fundamental principles that underly the design and operation of all types of direct-current machinery. Instead of attempting to touch the "high spots" in the whole field of direct-current engineering, attention has been concentrated upon certain important features that are ordinarily dismissed with little more than passing mention, but which, in the opinion of the author, are vital to a thorough grasp of the subject. For example, the book will be found to contain in Chapter III a full derivation of the rules covering armature windings (following Professor Arnold), in addition to the usual description of typical windings; Chapters VI and VII include a considerable amount of new material concerning the operating characteristics of generators and motors, the treatment being largely graphical and including the use of three-dimensional diagrams for depicting the mutual relationships among all of the variables; and in Chapters VIII and IX there has been developed a much more extensive treatment of the important subject of commutation than has been heretofore easily accessible to students of the type for whom the book is intended. In the selection and arrangement of the material dealing with commutation, care has been exercised to eliminate those minute details and excessive refinements that are more likely to confuse than to clarify.

Although the methods of the calculus have been freely used throughout the book, a conscious effort has been made to give special prominence to the physical concepts of which the equations are merely the short-hand expressions; to this end, the mathematical analysis has been preceded, wherever possible, by a full and copiously illustrated discussion of the physical facts of the problem and their relations to one another. This has been done to counteract the tendency, manifested by many students, to look upon a mathematical solution of a problem as an end complete in itself, apparently without a due realization

that the first essential is a clearly thought out analysis of physical realities. As an example of this procedure, attention is directed to the new material of Article 210 of Chapter XI.

The illustrative problems at the end of each of the first ten chapters have, for the most part, been designed to prevent the practice of feeding figures into one end of a formula and extracting the result (painlessly) from the other end. No attempt has been made to include as complete a set of problems as is desirable in studying the subject, for the reason that each instructor will naturally prepare a set to meet his own needs. Some of the problems at the end of Chapters VI and VII will be found to tax the reasoning powers of the best students, but all of them have been successfully solved in the author's classes. Answers have not been given in the text, but will be supplied upon request to those instructors who ask for them.

It is not to be expected that a new book on direct currents can avoid including much material common to the large number of existing texts on the subject. Such originality as has been brought to bear, aside from that represented by the new matter already referred to, has been exercised in selecting from the vast amount of available material those parts that seem most essential to an orderly presentation of the subject. Numerous well-known texts have been freely drawn upon, with suitable acknowledgment in all essential cases.

That part of Chapter IV which deals with details of the calculation of the magnetization curve and of magnetic leakage, and the part of Chapter VIII in which the formulas for armature inductance are developed, may be omitted without interfering with the continuity of treatment, in case design is taught as a separate course.

In conclusion, the author desires to express his sincere thanks to Professor H. E. Clifford, of Harvard University, who made helpful criticisms and suggestions after reading the original manuscript, and who also assisted in the proof reading; and to the various manufacturers who have kindly contributed illustrations.

ALEXANDER S. LANGSDORF.

CONTENTS

	PAGE
PREFACE	vii
TABLE OF SYMBOLS	xv

CHAPTER I

GENERAL LAWS AND DEFINITIONS	1
1. Introductory	1
2. Magnetic Field.—Paramagnetic and Diamagnetic Substances.	1
3. Unit Magnet Pole.	2
4. Field Intensity	3
5. Lines and Tubes of Force	3
6. Flux Issuing from a Magnet Pole	5
7. Magnetic Potential	6
8. Equipotential Lines and Surfaces	8
9. Induced Currents and E.M.F.	8
10. Direction of Induced E.M.F.	9
11. Force Due to a Current in a Magnetic Field	10
12. Unit Current.—Unit Quantity	11
13. Direction of the Force on a Conducting Wire	12
14. Magnitude of Induced E.M.F.	12
15. Lenz's Law	14
16. Practical Units of Current and E.M.F.	15
17. Heating Due to a Current	15
18. Field Intensity Due to a Circular Coil.	16
19. Field Intensity on the Axis of a Solenoid	17
20. Magnetic Potential on the Axis of a Circular Coil.	19
21. General Expression for the Magnetic Potential Due to a Coil of any Shape at any Point	20
22. Magnetomotive Force	21
23. Permeability	23
24. The Law of the Magnetic Circuit	26
25. Applications of Law of Magnetic Circuit.	27
26. Kirchhoff's Laws	30
27. Self-induction	32
28. Mutual Induction	34
29. Energy Stored in a Magnetic Field	37
30. Tractive Effort of Electromagnets	38

CHAPTER II

THE DYNAMO	43
31. Dynamo, Generator and Motor.	43

	PAGE
32. E.M.F. of Elementary Alternator	46
33. Induced and Generated E.M.F.	48
34. General Case of the E.M.F. of an Alternator	50
35. Rectification of an Alternating E.M.F.	52
36. Effect of Distributed Winding	52
37. Magnitude of E.M.F. Pulsations	55
38. Average E.M.F. of an Armature	56
39. Resistance of Armature Winding	57
40. Construction of Dynamos	58
41. Bipolar and Multipolar Machines	59
42. The Commutator	60
43. The Armature Core	62
44. The Pole Cores and Pole Shoes	65
45. The Yoke	66
46. Brushes, Brush Holders and Rocker Ring	66
47. Motor-generator. Dynamotor	68
48. Turbo-generators	70
49. Interpole Machines	71
50. The Unipolar or Homopolar Machine	72
51. Field Excitation of Dynamos.	73
52. Separate Excitation	73
53. Self-excitation	74
54. Series Excitation	74
55. Shunt Excitation	76
56. Compound Excitation	77
57. Construction of Field Windings.	79
58. Field Rheostats	81
59. Polarity of Generators.	83
60. Direction of Rotation of Motors	85

CHAPTER III

ARMATURE WINDINGS	88
61. Types of Armatures.	88
62. Types of Windings	89
63. Ring and Drum Windings	89
64. Winding Element.	90
65. Ring, Lap and Wave Windings	91
66. Number of Brush Sets Required	93
67. Simplex and Multiplex Windings. Degree of Reëntraney	94
68. General Considerations	95
69. Number of Conductors, Elements and Commutator Segments.	96
70. Winding Pitch, Commutator Pitch and Slot Pitch.	97
71. Field Displacement	98
72. Number of Armature Paths	98
73. General Rules	99
74. General Rule for the Degree of Reëntraney	103

	PAGE
75. Two-layer Windings	104
76. Examples of Drum Windings.	107
77. Equipotential Connections.	107

CHAPTER IV

THE MAGNETIZATION CURVE. MAGNETIC LEAKAGE	113
78. The Magnetization Curve	113
79. Experimental Determination of Magnetization Curve	115
80. Calculation of the Magnetization Curve	116
81. Magnetic Leakage	117
82. Details of Calculation of Magnetization Curve	119
83. Correction to Pole Arc	121
84. Corrected Axial Length	123
85. Ampere-turns Required for the Teeth	124
86. Ampere-turns Required for the Armature Core	128
87. Ampere-turns Required for the Pole Cores and Pole Shoes.	128
88. Ampere-turns Required for the Yoke	129
89. The Coefficient of Dispersion.	129

CHAPTER V

ARMATURE REACTION.	133
90. Magnetizing Action of Armature	133
91. Commutation	135
92. Components of Armature Reaction	137
93. Cross-magnetizing and Demagnetizing Ampere-turns	138
94. Cross-magnetizing and Demagnetizing Effect in Multipolar Machines	139
95. Corrected Expression for Demagnetizing Effect of Back Ampere- turns	143
96. Shape of Magnetic Field Produced by Armature Current	145
97. Approximate Distribution of the Resultant Field	147
98. Demagnetizing Component of Cross Magnetization	148
99. Excitation Required under Load Conditions	149
100. Experimental Determination of Flux Distribution.	152
101. Potential Curve	154
102. Predetermination of Flux Distribution in the Air-gap	155

CHAPTER VI

OPERATING CHARACTERISTICS OF GENERATORS	159
103. Service Requirements	159
104. Characteristic Curves	161
105. Regulation.	161
106. Characteristic Curves of Separately Excited Generator.	162
107. Effect of Speed of Rotation on the External Characteristic	165
108. Load Characteristic	166
109. The Armature Characteristic.	167

	PAGE
110. Characteristic Curves of the Series Generator	168
111. Dependence of the Form of the Characteristic upon Speed	170
112. Condition for Stable Operation	170
113. Regulation for Constant Current	171
114. Characteristics of the Shunt Generator	173
115. Dependence of the Form of the Characteristic upon Speed	177
116. Dependence of Form of Characteristic upon Resistance of Shunt Field Circuit	178
117. Approximate Mathematical Analysis of Shunt Generator Characteristics	179
118. Characteristic Curve of the Compound Generator.	181
119. The Series Shunt	184
120. Connection of Generators for Combined Output	185
121. The Thury System	185
122. Parallel Operation of Generators	186
123. Three-wire Generators.	191
124. Tirrill Regulator	195

CHAPTER VII

MOTORS.	199
125. Service Requirements	199
126. Counter E.M.F., Torque and Power	199
127. The Starting of Motors	202
128. Characteristics of the Separately Excited Motor	204
129. Characteristics of the Shunt Motor	208
130. Characteristics of the Series Motor	209
131. Characteristics of the Compound Wound Motor	211
132. Counter E.M.F. The Reversing Motor.	214
133. Starting of Differentially Wound Motors	215
134. Regulation of Speed of Shunt Motors	217
135. Applications of the Series Motor	221
136. Cycle of Operation of Railway Motors	225
137. Series-parallel Control.	227
138. Railway Controllers.	229
139. Division of Load between Motors.	235

CHAPTER VIII

COMMUTATION	237
140. Fundamental Considerations	237
141. Physical Basis of the Theory of Commutation	239
142. General Equation, Case of Simple Ring Winding	241
143. Elementary Mathematical Relations	243
144. Discussion of the General Equation.	245
145. Modified Form of Sparking Criterion	246
146. Linear Commutation	248
147. The Current Density at a Commutator Segment. General Case.	250

	PAGE
148. Variation of Local Current Density at the Brush	254
149. Further Examples	254
150. Simultaneous Commutation of Adjacent Coils	256
151. Successive Phases of Short-circuit in Coils of a Slot.	259
152. Selective Commutation in Wave Windings.	263
153. Duration of Short-circuit	263
154. Simultaneous Commutation of Several Coils. Effect of Wide Brushes	264
155. Calculation of the Self-inductance, L , in Slotted Armatures.	268
156. Calculation of the Mutual Inductance, M	273
157. The Commutating E.M.F.	276
158. Pulsations of Commutating Field	280
159. Sparking Constants	281
160. Reaction of Short-circuit Current upon Main Field	282
161. The Armature Flux Theory	283

CHAPTER IX

COMPENSATION OF ARMATURE REACTION AND IMPROVEMENT OF COM- MUTATION	286
162. Principle of Compensation	286
163. Compensating Devices	287
164. Commutating Devices.	290
165. Commutation in Machines having no Auxiliary Devices	292
166. Commutating Poles.	297
167. Winding of Commutating Poles.	298
168. Effect of Commutating Poles upon Coil Inductance.	300
169. Compounding Effect of Commutating Poles	301

CHAPTER X

EFFICIENCY, RATING AND HEATING	304
170. Sources of Loss	304
171. The Ohmic Losses	304
172. The Core Losses	306
173. Mechanical Losses	314
174. Additional Losses.	315
175. Summary of Losses	316
176. True Efficiency, Efficiency of Conversion, Electrical and Me- chanical Efficiency	317
177. The Stray Power Loss.	318
178. Variation of Efficiency with Load. Condition for Maximum Efficiency	321
179. Location of Point of Maximum Efficiency	324
180. All-day Efficiency.	325
181. Rating and Capacity	326
182. Allowable Operating Temperatures	327
183. Heating of Railway Motors	332

	PAGE
184. Temperature Specifications of Electric Power Club	334
185. Output Equation	334
186. Heating and Cooling Curves	336
187. Heating of the Armature	340
188. Heating of the Field Coils	343
189. Heating of the Commutator	345
190. Rating of Enclosed Motors	345

CHAPTER XI

BOOSTERS AND BALANCERS. TRAIN LIGHTING SYSTEMS	347
191. Boosters	347
192. The Series Booster	347
193. The Shunt Booster	348
194. The Constant-current or Non-reversible Booster	350
195. Reversible Booster	353
196. Auxiliary Control of Boosters	354
197. The Hubbard Counter E.M.F. System	354
198. The Entz System	355
199. The Bijur System	357
200. Balancers	358
201. Train Lighting	359
202. Voltage Regulation in Train Lighting Systems	360
203. Resistance Regulation	362
204. Generator Field Regulation	362
205. Field and Line Regulation	364
206. Regulation by Means of Armature Reaction	366
207. The Rosenberg Train Lighting Generator	366
208. Operation of Rosenberg Machine as a Motor	373
209. Modification of the Rosenberg Type of Generator	374
210. The Wagner Automobile Lighting Generator	376
INDEX	395

TABLE OF SYMBOLS

(The figures refer to the page on which the symbol is first introduced; symbols formed from those given below by the mere addition of subscripts or primes for the purpose of distinguishing between quantities having the same general meaning, are not separately listed. Unless otherwise indicated, metric units are implied. Inch units are distinguished in the text by the use of the double prime ("').

In a few instances the same symbol has been used to represent more than one quantity, though such cases are widely separated in the text, and the meaning may readily be determined from the lettering of the accompanying illustrations or from the context.)

A

	PAGE
a constant length	39
number of armature circuits	57
constant in Froelich's equation	179
radiating surface	340
a_x cross-section of tube of flux	156
at amp-turns per cm	117
at_a amp-turns per cm., armature core	116
at_c amp-turns per cm., pole core	116
at_g amp-turns per cm., air-gap	116
at_s amp-turns per cm., pole shoes	116
at_t amp-turns per cm., teeth	116
at_y amp-turns per cm., yoke	116
A area, sq. cm.	4
A_a cross-section of armature core	116
A_b total area of brush contacts	315
A_c cross-section of pole cores	116
A_g cross-section of air-gap	116
A_s cross-section of pole shoe	116
A_t cross-section of teeth under pole	116
A_y cross-section of yoke	116
AT amp-turns per pair of poles	116
AT_a amp-turns required for armature core	116
AT_{arm} armature amp-turns	300
AT_c amp-turns required for pole core	116
$(AT)_d$ demagnetizing amp-turns per pair of poles	138
AT_g amp-turns required for air-gap	116

	PAGE
AT_{ic} amp-turns required for two interpole cores	300
AT_{ig} amp-turns required for two interpole air-gaps	300
AT_{it} amp-turns required for two sets of teeth opposite interpoles	300
AT_s amp-turns required for pole shoes	116
AT_t amp-turns required for teeth	116
AT_y amp-turns required for yoke	116

B

b pole arc	119
constant in Froelich's equation	179
brush width	241
b' corrected pole arc	119
b_c peripheral width of pole core	131
b'_i corrected arc of commutating pole	299
b_s width of slot	122
b_t width of tooth at tip	125
b'_t width of tooth at root	308
b_v width of ventilating duct.	123
b_o width of slot opening	270
B flux density	24
B' amplitude of flux pulsations at pole face	313
B_a flux density in armature core	116
field intensity in axis of commutation due to armature current	280
B_c flux density in pole core	116
field intensity at pole tip due to armature cross-field	141
B_g flux density in air-gap	116
B_{ig} flux density in air-gap due to interpoles	299
B_s flux density in pole shoes.	116
B_t flux density in teeth	116
B'_t apparent flux density in teeth.	125
B_y flux density in yoke	116
B_o field intensity in axis of commutation, no-load	279

C

c constant	309
C constant	34

D

d diameter	47
diameter of armature	146
d_c diameter of pole core	131
d_{com} diameter of commutator	281
D distance or length	17

E

	PAGE
<i>e</i> e.m.f. in volts.	36
commutating e.m.f. at beginning of period of commutation	242
e_{max} maximum reactance voltage	248
e_r drop in shunt field rheostat.	79
average e.m.f. of self-induction	247
$e_{s.c.}$ e.m.f. in short-circuited coil.	389
\bar{E} e.m.f. in volts.	15
\bar{E} e.m.f. in abvolts	12
E_a counter e.m.f.	77
E_b e.m.f. generated in field axis, Rosenberg generator	369
E_c commutating e.m.f.	242
E_{co} commutating e.m.f., no-load	279
E_{cl} commutating e.m.f., load.	280
E_t terminal or line voltage	77
E_T commutating e.m.f. at end of period of commutation	245

F

<i>f</i> force in dynes	3
field step in terms of single pole pitch	100
frequency of magnetic reversals	306
coefficient of friction.	315
F force in dynes	39

H

<i>h</i> radial depth of armature core under teeth	128
circular mils per ampere	335
h_c radial length of pole core	131
h_s radial length of pole shoe.	130
h_1 depth of armature coil	269
h_2 depth of straight part of slot above lower coil	269
h'_2 depth of straight part of slot above upper coil	270
h_3 depth of inclined part of tooth-tip	270
h_4 depth of tooth overhang	270
H field intensity.	3
H_e field intensity at end of solenoid	18
H_o field intensity at center of coil or solenoid	17

I

<i>i</i> current in amperes	31
current in line	77
current in short-circuited coil	243
i_a total armature current	57

	PAGE
$(i_a)_o$ armature current, no-load	319
i_b exciting current, Rosenberg generator	369
i_f field current, separately excited machine	162
i_l linear component, short-circuit current	250
i_s shunt field current	77
i_x extra component of short-circuit current	250
$i_o = i_a/a$ current per armature path	237
I current in amperes	11
\bar{I} current in abamperes	10

K

k constant	3
lamination factor	125
correction factor, pole face loss	313
K constant	34
ratio of iron section to air section under a pole	125

L

l length	3
axial length of core	119
l' corrected length of core	119
l_a length of magnetic path in armature	116
total length of wire on armature	305
l_c length of magnetic circuit in pole core	116
axial length of pole core	131
l_{com} axial length of commutator	345
l_f total length of end-connections of element	271
l'_i corrected axial length of interpoles	299
l_s length of magnetic path in pole shoes	116
l_t mean length of turn	79
length of magnetic path in teeth	116
l_y length of magnetic path in yoke	116
l_1 distance between adjacent pole shoes	130
l_3 distance between inner surfaces of pole cores	131
L self-inductance in henries	33
L_b self-inductance of coil edge at bottom of slot	269
L_s self-inductance of shunt field winding	82
L_t self-inductance of coil edge at top of slot	270
L_1 self-inductance of element due to slot leakage	270
L_2 self-inductance of element due to tooth-tip leakage	270
L_3 self-inductance of element due to end-connection leakage	271

M

m strength of magnet pole	3
---------------------------------------	---

field displacement in terms of commutator segments	98
M coefficient of mutual-induction	36
M_{12} coefficient of mutual-induction between coils in adjacent slots.	275
M_{13} coefficient of mutual-induction between coils separated by one slot	276

N

n revolutions per minute	47
number of coil edges per element	98
number of coil edges carrying reversed current in neutral zone	144
n_f turns per pair of poles, separately excited machine	162
turns per pair of poles, series machine	168
n_s turns per pair of poles, shunt machine	79
n_{sc} number of coils simultaneously short-circuited by brush	280
n_v number of ventilating ducts	125
n_o ideal no-load speed of motor	206
N number of turns of coil or circuit	14

P

p constant distance	11
number of poles	50
p_c brush pressure, lbs. per sq. in.	315
P power	13
permeance	123
summation of losses	317
P_{bf} brush friction loss	315
P_{ca} copper loss, armature	305
P_{cc} copper loss, commutator	306
P_{cf} copper loss, field	305
P_{const} constant part of power loss	322
P_{ca} eddy current loss, armature core	310
P_{et} eddy current loss, teeth	312
P_{ha} hysteresis loss, armature core	306
P_{ht} hysteresis loss, teeth	308
P_{h+c} combined hysteresis and eddy current loss	322
P_p loss in pole face	313
P_s stray power loss.	319
P_o rated output	324

Q

q degree of reëntrançy	103
amp-conductors per cm. of armature periphery	146
Q heat generated per sec., kg-cal.	336
\bar{Q} quantity of electricity, abcoulombs	12

TABLE OF SYMBOLS

<i>R</i>		PAGE
<i>r</i>	distance, radius	3
	resistance of shunt around series field	172
<i>r'</i>	resistance of armature and starting rheostat	201
<i>r_a</i>	resistance of armature including brushes and brush contacts.	57
<i>r_f</i>	resistance of series field winding	79
	resistance of separately excited field winding	162
<i>r_s</i>	resistance of shunt field winding	77
<i>R</i>	resistance in ohms	15
<i>R_a</i>	total resistance of all wire on armature	57
<i>R_b</i>	resistance of entire brush contact	244
<i>R_c</i>	resistance of short-circuited coil	244
<i>R_l</i>	resistance of commutator lead	244

S

<i>s</i>	distance	13
	number of winding sections	55
	diagonal of rectangular coil section	271
	specific heat	336
<i>s_a</i>	cross-section of armature conductor	305
<i>S</i>	number of commutator segments	96

T

<i>t</i>	time in seconds	13
	tooth pitch	122
	working temperature of armature, deg. C.	305
	thickness of laminations	309
<i>t_v</i>	distance center to center of ventilating ducts	123
<i>T</i>	period of commutation, seconds	136
	torque	201

V

<i>v</i>	velocity	13
	peripheral velocity of armature	281
<i>v_c</i>	peripheral velocity of commutator	264
<i>V</i>	energy, work, potential	6
	velocity	47
	volume of core	306
<i>V_t</i>	volume of tooth	308

W

<i>w</i>	watts radiated	340
----------	--------------------------	-----

	PAGE
W work, energy	12
weight of core	306
W_c loss at brush contact	250
W_R loss in rheostat	228

X

x variable distance	6
X amp-turns required for double air-gap, two sets of teeth and armature core	129

Y

y commutator pitch	97
y_1 back pitch	97
y_2 front pitch	97

Z

z number of conductors per coil edge	269
Z number of armature conductors	47
$Z' = \frac{p}{a} \frac{Z}{60 \times 10^3}$	201

 α

α angle	4
angle of brush displacement from neutral	138
coefficient of cooling	336
constant	383

 β

β angle subtended by pole arc	119
width of commutator segment	241
constant	383
β' supplement of double angle of brush lead	139

 γ

γ specific resistance of core material	310
constant	383

 δ

δ length of single air-gap	116
---	-----

	PAGE
δ' corrected length of single air-gap	122
δ'_i corrected length of single air-gap under commutating pole	301
δ_x length of tube of flux in air-gap	156
Δ relative shift of segments with respect to brushes	257
Δe brush drop	164
ϵ	
ϵ eddy current constant	312
η	
η hysteresis constant	306
efficiency	317
θ	
θ variable angle	7
rise of temperature, deg. C.	331
λ	
λ number of flux linkages	20
Λ Carter sparking criterion	267
μ	
μ permeability	24
ν	
ν coefficient of dispersion or leakage coefficient	118
ν_i coefficient of dispersion of interpoles	299
ξ	
ξ output coefficient	335
ρ	
ρ specific resistance of copper.	79
σ	
σ intensity of magnetization	39
correction factor for fringing flux	122

	PAGE
τ	
τ pole pitch	50
φ	
φ angle	10
leakage flux per pole	118
φ_1 leakage flux, inner surfaces of pole shoes	130
slot leakage flux	268
φ_2 leakage flux, lateral surfaces of pole shoes	130
tooth-tip, leakage flux	268
φ_3 leakage flux, inner surfaces of pole cores	131
end-connection leakage flux	268
φ_4 leakage flux, lateral surfaces of pole cores	131
ϕ flux	14
Φ flux	4
useful flux per pole	47
Φ_b field flux, Rosenberg generator	369
Φ_B armature flux, Rosenberg generator	369
Φ_i useful flux due to interpole	299
Φ_{ii} total flux due to interpole	299
Φ_t total flux per pole	118
ψ	
ψ ratio of pole arc to pole pitch	142
ω	
ω solid angle	19



PRINCIPLES OF DIRECT CURRENT MACHINES

CHAPTER I

GENERAL LAWS AND DEFINITIONS

1. Introductory.—A clear conception of the theory underlying the design and the operating characteristics of electrical machinery depends upon a thorough understanding of a few fundamental physical facts concerning the properties of electricity and magnetism and of the formulation of these facts as laws or definitions. The object of this chapter is to present in condensed form those facts, laws and definitions which are immediately applicable to the theory of direct-current machines. For a more extended treatment of these basic principles the student is referred to the numerous texts in which the subject is treated in detail.

2. Magnetic Field.—**Paramagnetic and Diamagnetic Substances.**—The space surrounding a magnet is called a *magnetic field*. The existence of a magnetic field is manifested by the measurable mechanical forces which act upon magnetic substances or upon electric currents in the field. In the case of a magnet of elongated form, the force due to it is greatest near its extremities, and these are referred to as the poles of the magnet. If such a magnet is freely suspended at its center of gravity, it will turn until its polar axis coincides with the magnetic meridian at the point of support provided it is subjected to the influence of the earth's field only. The north-seeking end of the magnet is called the north or positive pole, and the south-seeking end is called the south or negative pole. Experiment shows that if two such magnets are placed near each other poles of like sign will repel each other and poles of unlike sign will attract each other.

The magnetic fields produced by natural magnets like the

lodestone, and by artificially made permanent magnets, are not sufficiently powerful for practical purposes except that permanent magnets are used in small magneto-generators and in some types of measuring instruments. The powerful magnetic fields required in generators and motors are always produced by the magnetizing action of an electric current.

Experiment shows that iron and steel are attracted by a magnet when placed in the field of the latter. This property is also possessed by nickel and cobalt but to a less extent than in the case of iron. Other substances, of which bismuth is the most prominent example, are repelled by a magnet. Materials of the former class are called *paramagnetic* substances, those of the latter class are called *diamagnetic* substances. The classification of a material as paramagnetic or diamagnetic depends upon the nature of the medium in which it is immersed. The medium used as the standard of reference is air, which is assumed to be neutral or non-magnetic in its properties. Since paramagnetic substances, iron and steel in particular, are used in practice to the virtual exclusion of all others, they are usually called simply magnetic substances.

If a magnetic substance, originally unmagnetized, is brought into a magnetic field, it will become *magnetized by induction* in such a way that the induced pole adjacent to the nearest inducing pole will have a polarity opposite in sign to that of the inducing pole.

3. Unit Magnet Pole.—Every magnetized body exhibits the phenomenon of polarity, that is, the simultaneous existence of poles of opposite sign. One polarity cannot exist without the other. The magnetized condition obtains throughout the entire mass of the magnet, but its intensity generally varies from point to point. In speaking of the pole of a magnet it should be understood that there is no one point at which the magnetism is actually concentrated, but the conception of concentrated point poles is useful for purposes of computation even though the idea is artificial. In the case of a long, slim magnet, like a knitting needle, the magnetism acts as though it were mostly concentrated at or near the ends, so that such a magnet approximates fairly well the condition of concentrated point poles. In particular, if one pole of such a magnet is placed in a magnetic field, its other pole being so far removed as to be acted upon with little or no force, the

magnet will behave as though it consisted of a single isolated pole, and the forces acting upon it can then be studied.

For purposes of quantitative measurement, a *unit magnet pole* is defined as a *point pole of such strength that it will exert a force of 1 dyne upon an equal pole at a distance of 1 cm., both poles being in air.* The force will be a repulsion if the two unit poles are of the same sign; it will be an attraction if they are of opposite sign.

If a unit pole is placed 1 cm. away from a pole of unknown strength, the surrounding medium being air, and the force between them is found to be m dynes, it is assumed that the second pole has a strength of m units. In other words, the strength of a magnet pole is measured by the force in dynes with which it acts upon (or is acted upon by) a unit pole at a distance of 1 cm., in air. Two magnet poles of strength m and m' , respectively, placed 1 cm. apart, will then act upon each other with a force of mm' dynes, in accordance with this definition.

In 1800 Coulomb discovered the fact that the force of attraction or repulsion between two magnet poles is inversely proportional to the square of the distance between them. In general, the force between two poles m and m' separated by a distance r is then

$$f = k \frac{mm'}{r^2} \quad (1)$$

If force is measured in dynes, distance in centimeters, and pole-strength in terms of the unit defined above, then when m , m' , and r are all equal to unity, f is likewise unity, hence $k = 1$, or

$$f = \frac{mm'}{r^2} \text{ dynes} \quad (2)$$

4. Field Intensity.—The *intensity* of a magnetic field at a given point is measured by the force in dynes which acts upon a unit magnet pole placed at that point. It is represented by the symbol H . A field is of unit intensity at a particular point when it acts upon a unit magnet pole at that point with a force of one dyne. This unit field intensity (in air) is called the *gauss*. A field intensity of H gaussess then means a field which will act upon a unit pole with a force of H dynes, or with a force of mH dynes upon a point pole of strength m units.

5. Lines and Tubes of Force.—If a unit magnet pole is moved about in a magnetic field, the force acting upon it will in general

vary in magnitude and direction from point to point. At each point in the field the force can be represented by a line whose length is proportional to the magnitude of the force and whose direction coincides with that of the force. If curves are now drawn in such a manner that their tangents are at each point in the direction of the force at that point, such curves are *lines of magnetic force*. Obviously there will be an infinite number of such lines in any magnetic field, since there is an infinite number of points which do not lie on one and the same line of force. It is also clear that lines of force cannot intersect, for if they did, each of the intersecting curves would have a different tangent at the point of intersection, therefore implying that a magnetic pole placed at that point would simultaneously experience more than one force—a condition that is clearly impossible.

The positive direction of a field or of a line of force is that in which a free north pole would move.

Although the number of actual lines of force in any magnetic field is infinite, it is convenient to picture the field as characterized by a finite number of conventionalized lines of force. This is accomplished by representing a field of intensity H , in air, by H lines per sq. cm. of cross-section taken at right angles to the direction of the field. In a *uniform magnetic field* the force is everywhere the same and in the same direction, in which case the total number of lines, or the magnetic *flux*, crossing an area A is

$$\Phi = AH$$

If the area is not at right angles to the field, the flux crossing it is

$$\Phi = AH \cos \alpha \quad (3)$$

where α is the angle between H and the normal to the plane section. In the case of a non-uniform field,

$$\Phi = \int H \cos \alpha \, dA \quad (4)$$

where dA is a differential element of the surface, H is the field intensity at the element, and α is the angle between H and the normal to the element. The total flux across an area is usually expressed in lines; the International Electrical Congress of 1900 adopted the name *maxwell* to represent unit flux, but this is seldom used.

A bundle of lines of force threading through a given area will converge or diverge as the field intensity increases or decreases, respectively. The outer lines of such a bundle constitute the elements of a tubular surface, Fig. 1, and the entire bundle is called a *tube of force*. The total flux across all sections of a tube of force is the same, or

$$\int H' \cos \alpha' .dA' = \int H'' \cos \alpha'' .dA''$$

for by hypothesis the longitudinal walls of the tube are made up of lines of force, and since lines of force cannot intersect, no flux can cross the walls of the tube.



FIG. 1.—Tube of force.

This fact can be otherwise stated by saying that the flux across the walls of a tube of force is zero.

6. Flux Issuing from a Magnet Pole.—If a unit magnet pole is placed at a distance of r cm. from a pole of strength m units, it will be repelled with a force of

$$f = \frac{m}{r^2} \text{ dynes}$$

This is equivalent to saying that the field intensity at a distance of r cm. from a pole of m units is $H = \frac{m}{r^2}$ gaussess.

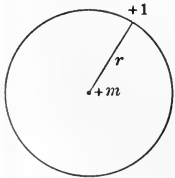

Since the locus of all points distant r cm. from m is a sphere having m as center and a radius r , as in Fig. 2, the field intensity will be the same at all points on its surface, and the direction of the field will be at each point along the radius to that point. The total flux across the surface of the sphere is then

FIG. 2.—Field intensity around magnet pole.

$$\Phi = AH = 4\pi r^2 \times \frac{m}{r^2} = 4\pi m \text{ lines (or maxwells)} \quad (5)$$

The flux from a unit magnet pole is, therefore, 4π lines.¹

¹ The quantity 4π recurs in many of the equations that apply to magnetic and electric problems. Its presence in certain of these equations has been objected to by some scientists because of its incommensurable nature, and attempts to eliminate it from these equations have been proposed. This can be done by suitable changes in the definitions of some of the fundamental units. (Trans. International Electrical Congress, Vol. I, p. 130, 1904.) It is interesting, however, to note that 4π appears in the results

7. Magnetic Potential.—Let Fig. 3 represent two magnet poles of strengths m and m' units, respectively, separated by a distance x cm. Each will repel the other with a force of $\frac{mm'}{x^2}$ dynes. Let one of the poles, as m' , move a distance dx under the influence of this force, then work will be done to the extent of

$$dV = \frac{mm'}{x^2} \cdot dx \text{ ergs}$$

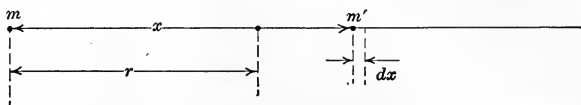

FIG. 3.—Determination of potential energy of two magnet poles.

The entire amount of the work done in separating the two poles to an infinite distance, from an initial separation of r cm., is

$$V = \int_r^\infty \frac{mm'}{x^2} dx = \frac{mm'}{r} \text{ ergs} \quad (6)$$

Since no work has been done upon the system by any outside agency during this process, the work represented by the expression $\frac{mm'}{r}$ must have come from the system itself, and therefore represents the *stored* or *potential energy* of the two poles in each other's presence. It represents also the amount of work or energy required to bring one pole from an infinite distance into the presence of the other, with a separation of r cm.; for this is given by

$$V = \int_\infty^r \frac{mm'}{x^2} (-dx) = \frac{mm'}{r}$$

or the same as before. If $m' = 1$, the expression becomes $\frac{m}{r}$, which represents the potential energy of a unit magnet pole placed r cm. from a pole m ; or it is the *magnetic potential* due to a pole m at a distance of r cm. from the pole.

because it is an inherent function of the geometry of space, as is clearly evident from the above evaluation of the flux issuing from a pole. If the quantity 4π is eliminated from some expressions, it will inevitably reappear in others.

The work required to move a unit magnet pole from one point to another in a magnetic field can be calculated as follows:

Let P_1 , Fig. 4, be the initial, and P_2 the final position of the unit pole, and let the path between them be any curve whatsoever. At any general point on the curve, distant r cm. from m , the force will be $\frac{m}{r^2}$, and the direction of this force will be displaced from the elementary path ds by an angle θ . The work done over the distance ds will be

$$dV = \frac{m}{r^2} ds \cos \theta = \frac{m}{r^2} dr$$

and the total work in going from P_1 to P_2 will be

$$V_{1-2} = \int_{r_1}^{r_2} \frac{m}{r^2} dr = \frac{m}{r_1} - \frac{m}{r_2} \quad (7)$$

But $\frac{m}{r_1}$ is the magnetic potential at P_1 , and $\frac{m}{r_2}$ is the magnetic potential at P_2 . Hence the work done by the agency producing the magnetic field upon a unit magnet pole which moves from one point to another in the field is simply the *difference of magnetic potential* between the points, and is independent of the path followed in the travel from one point to the other.

If the magnetic potential of the terminal point of the travel is higher than that of the starting point, work must be done by an external agency to produce the motion of the unit testing pole, and the work so performed reappears as increased potential energy of the system. If such a system is left to itself, the stored energy will be dissipated by the separation of the poles under the influence of their mutually repelling forces, provided the poles are free to move.

If, in the above discussion, the pole $+m$ is replaced by an equal pole of opposite sign, or $-m$, all of the expressions for the forces and potentials will be reversed in sign. Repulsions become attractions and work done *by* the system becomes work done *upon* the system. This case is entirely analogous to that of two heavy particles of ordinary matter which attract each other with

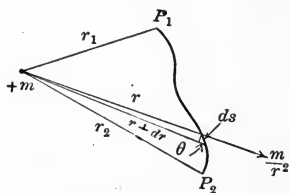

FIG. 4.—Determination of difference of magnetic potential between two points in a magnetic field.

a force proportional to the product of the masses of the particles and inversely proportional to the square of the distance between them. In the case of attracting *magnet* poles the *magnetic* potential energy is the work required to move one pole to an infinite distance from the other; in the case of attracting *gravitational* masses the *gravitational* potential energy is also the work required to move one of them to an infinite distance from the other. On the one hand the work is done by moving *magnet* poles in a *magnetic* field; on the other hand by moving *gravitating* matter in a *gravitational* field.

8. Equipotential Lines and Surfaces.—The locus of all points in a magnetic field which have the same magnetic potential is called an *equipotential surface*. Linear (or curvilinear) elements of such a surface, connecting points of equal potential, are called *equipotential lines*. No work is required to carry a magnet pole from point to point in an equipotential surface or line. It follows, therefore, that the lines of force must intersect the equipotential surfaces at right angles, for if they did not there would be a component of force acting along the tangent to the equipotential surface at the point of intersection, consequently work would be required to move the pole along the surface, which is contrary to the assumption.

9. Induced Currents and E.M.F.—It was discovered by Faraday in 1831 that a closed conductor which is threaded

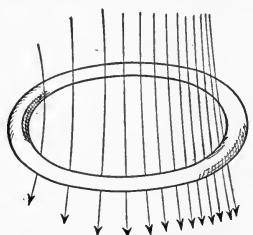

FIG. 5.—Conducting circuit in magnetic field.

by, or linked with, a magnetic field will have a current induced in it when the strength of the field is altered. This phenomenon is called *electromagnetic induction*, and may be demonstrated in a number of different ways. Thus, if the stationary closed conducting ring of Fig. 5 is threaded by lines of magnetic force whose number changes from instant to instant, a current will flow in the ring; again, there will be a current flow if the field is steady and the ring is rotated around a diameter so as alternately to include and exclude the magnetic flux; and again if the field is steady and the ring is given a motion of translation parallel to itself from a region where the field has a certain intensity to a region

where the intensity is different; but if the ring be given a simple motion parallel to itself in a field of uniform intensity there will be no induced current.

It should be borne in mind that the flow of current in the various cases mentioned above is dependent upon the condition that the circuit be closed. The induced current is a secondary phenomenon, the primary effect of the changing magnetic field being to induce an *e.m.f.* which in turn produces the current.¹ For instance, let the wire *ab* move to the

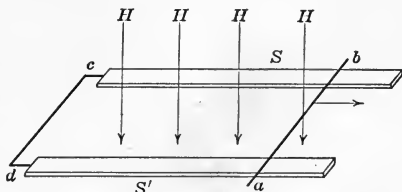

FIG. 6.—Development of E.M.F.

right along the rails *SS'*, Fig. 6, and let *H, H* represent magnetic lines of force at right angles to the plane of the rails. There will result a displacement of electricity along the wire *ab*, a positive charge appearing at *b* and a negative charge at *a*. This means that there will be a difference of electrical potential (Art. 14) between *a* and *b*; if then the rails are joined by a conductor *cd*, a current will flow around the closed circuit *abcd*, but the difference of electrical potential may exist independently of the current, as for instance, when the circuit is open.

10. Direction of Induced E.M.F.—

Fleming's Right-hand Rule.—A convenient method of determining the direction

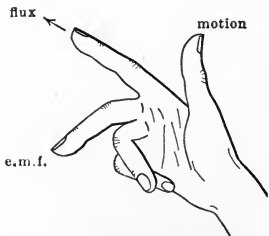

FIG. 7.—Fleming's right-hand rule. Generator action.

¹ If an electrical circuit that is not closed upon itself is "cut" by lines of magnetic force, as described above, what actually occurs is a displacement of electricity along the conductor in a direction mutually perpendicular to the direction of the field and to the direction of motion of the conductor. While the electricity (consisting of electrons) is in process of displacement, its movement constitutes a true current, but currents of this sort are called displacement currents to distinguish them from the dynamic currents ordinarily dealt with in direct-current circuits. Strictly, therefore, the primary effect of a changing magnetic flux upon a conducting electrical circuit is to produce a displacement current, which in turn gives rise to a difference of electrical potential between the terminals of the circuit, and a (dynamic) current if the circuit be closed.

of the induced e.m.f. and of the resulting current if the circuit is closed is known as Fleming's rule, which is as follows: Hold the thumb, forefinger and middle finger of the *right hand* mutually perpendicular to one another, like the three axes of space coordinates, as illustrated in Fig. 7; point the forefinger in the direction of the lines of force, the thumb in the direction of the motion of the wire, then the middle finger will point in the direction of the induced e.m.f.

11. Force Due to a Current in a Magnetic Field.—The definition of unit current in the absolute electromagnetic system of units is based upon Oersted's discovery that a current of electricity will deflect a compass needle in its neighborhood. This fact was put into mathematical form by Laplace as follows:

Let dl , Fig. 8a, represent an element of a wire ab , which is carrying a current of \bar{I} absolute units (abamperes, see Art. 12), and let

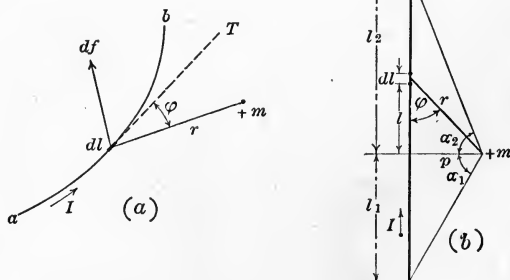

FIG. 8.—Force due to current in a magnetic field.

m be a magnet pole of strength m units. The force acting on the element dl will then be

$$df = \frac{m}{r^2} \bar{I} dl \sin \varphi \text{ dynes}^1 \quad (8)$$

where φ is the angle between the radius vector r and the tangent T to the wire at the element. The direction of this force is perpendicular to the plane through r and T , and under the conditions shown in the figure will be directed upward. Conversely, the pole m will be acted upon by an equal force, directed downward.

¹ This relation is also known as the law of Biot-Savart.

In equation (8), $\frac{m}{r^2}$ is the field intensity at the element due to m . Hence

$$df = H\bar{I} dl \sin \varphi$$

If r is perpendicular to dl , $\sin \varphi = 1$, in which case

$$df = H\bar{I} dl$$

It follows, therefore, that if a straight wire l cm. long carrying a current of \bar{I} abamperes is placed in a uniform field of intensity H in such a manner that its length is perpendicular to the lines of force (Fig. 9a), it will be acted upon by a force

$$f = H\bar{I}l \text{ dynes} \tag{9}$$

If the axis of the wire makes an angle φ with the direction of the flux (Fig. 9b), the force becomes

$$f = H\bar{I}l \sin \varphi \tag{10}$$

Equation (8) serves to determine the force exerted on a magnet pole m , Fig. 8b, by a current \bar{I} flowing in a wire of infinite length, the pole being at a distance p cm. from the axis of the wire. Thus,

$$f = 2 \int_0^\infty \frac{m \bar{I} dl}{l^2 + p^2} \sin \varphi = 2mp\bar{I} \int_0^\infty \frac{dl}{(l^2 + p^2)^{3/2}} = \frac{2m\bar{I}}{p}$$

if $m = 1$, f becomes the field intensity, H , at a distance p from a straight wire of infinite length carrying \bar{I} abamperes; or

$$H = \frac{2\bar{I}}{p} = \frac{2\bar{I}}{10p} \tag{11}$$

where I is the current in amperes (see Art. 16).

If the wire is of finite length and $m = 1$,

$$H = \int_{-l_1}^{+l_2} \frac{\bar{I} dl}{l^2 + p^2} \sin \varphi = \frac{\bar{I}}{p} (\sin \alpha_1 + \sin \alpha_2) \tag{12}$$

12. Unit Current.—Unit Quantity.—It follows from equation (9) that the absolute unit of current may be defined as a current of such strength that if it flows in a straight wire 1 cm. long placed perpendicular to the lines of force of a uniform magnetic field of

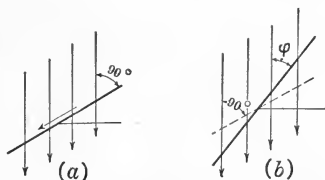

FIG. 9.—Force due to a current in a magnetic field.

unit intensity, the wire will experience a side thrust of 1 dyne. This absolute unit of current is called the *abampere*.

Unit quantity of electricity (in the same absolute electromagnetic system of units) may then be defined as that amount of electricity which will pass a given cross-section of a conductor in one second when the current strength is one abampere. This unit of quantity is called the *abcoulomb*.

13. Direction of the Force on a Conducting Wire.—*Fleming's Left-hand Rule.*—Equation (10) shows that whenever a wire carrying a current lies in a magnetic field there is a force exerted upon

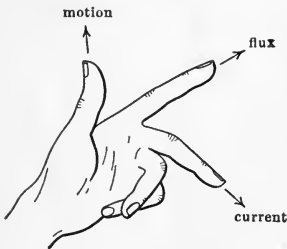

FIG. 10.—Fleming's left-hand rule. Motor action.

it amounting to $Hl\sin\phi$ dynes. This action is utilized in the electric motor, which consists essentially of a number of wires carrying currents and arranged to rotate in a powerful magnetic field. It is important to be able to determine the direction of the force acting on a wire for any given set of conditions. This can be done by means of *Fleming's left-hand rule*:

Hold the thumb, forefinger and middle finger of the *left hand* mutually perpendicular to one another, as shown in Fig. 10. Point the forefinger in the direction of the lines of force and the middle finger in the direction of the current, then the thumb will point in the direction of the force on the wire. It will be noted that this rule is the same as Fleming's rule for the direction of the induced e.m.f. (generator action) except that the left hand is used instead of the right hand.

14. Magnitude of Induced E.M.F.—Unit difference of electrical potential in the absolute electromagnetic system is said to exist between two points in an electrical field or in an electrical circuit when unit work (the erg) is expended in moving unit quantity of electricity (the abcoulomb) from the one point to the other. This unit is called the *abvolt*. If, then, \bar{Q} abcoulombs are moved from one point in a circuit to another point whose electrical potential differs from that of the first point by \bar{E} abvolts, the work done is

$$W = \bar{E}\bar{Q} \text{ ergs}$$

If this work is done in a time t seconds, the power, or rate of doing work, is

$$P = \frac{W}{t} = \overline{E} \frac{\overline{Q}}{t} = \overline{EI} \text{ ergs per second} \quad (13)$$

since $\overline{Q}/t = \overline{I}$ (Art. 12).

Consider now the circuit of Fig. 11, and let the wire ab of length l cm. move to the right with a velocity $v = ds/dt$ cm. per second. There will be generated in the wire an e.m.f. of, say, \overline{E}

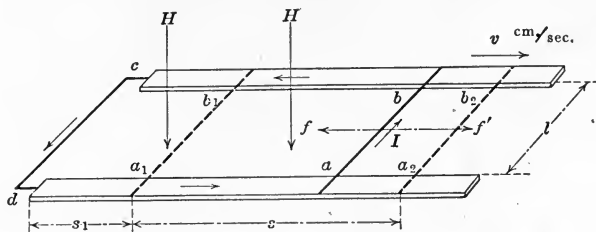

FIG. 11.—Moving conductor in a magnetic field.

abvolts, in accordance with Faraday's law, and a current of \overline{I} abamperes will be set up. The power developed will be \overline{EI} ergs per second and the energy developed during a time dt will be

$$dW = \overline{EI} dt \text{ ergs}$$

The current \overline{I} in the wire ab will produce a thrust of

$$f = H\overline{I}l \text{ dynes}$$

acting toward the left, hence the work done in overcoming this force through a distance ds will be

$$dW = H\overline{I}l ds$$

and by the principle of the conservation of energy

$$\overline{EI} dt = H\overline{I}l ds$$

or

$$\overline{E} = Hl ds/dt = Hlv \text{ abvolts} \quad (14)$$

But the expression Hlv is numerically equal to the number of lines of force cut per second by the moving wire. Hence the e.m.f. (in absolute units) is equal to the number of lines of force cut per second.

In the above discussion it was tacitly assumed that the magnetic field swept across by the moving wire was uniform, and by supposition the velocity was constant. But if the field is not uniform, and if the velocity is variable, equation (14) still holds rigidly true; the e.m.f. will simply vary from instant to instant in such a manner that the equation is continuously satisfied.

Let the wire start from position a_1b_1 and move to position a_2b_2 . The flux originally linked with circuit a_1b_1cd is

$$\phi_1 = Hls_1$$

and in the final position the flux enclosed is

$$\phi_2 = Hl(s_1 + s)$$

The change of flux during the movement is

$$\phi = \phi_2 - \phi_1 = Hls$$

and if this change occurs in t seconds the average rate of change is

$$\frac{\phi}{t} = Hl \frac{s}{t} = Hlw_{average} = \bar{E}_{average}$$

which, in words, states that the average induced e.m.f. is equal to the average rate of change of flux linked with the circuit. If the rate of change of flux is not uniform, the resulting variable e.m.f. will at any instant be given by

$$\bar{E} = \frac{d\phi}{dt} \quad (15)$$

which is a general form of the equation expressing Faraday's law.

If the circuit linked with the flux has N turns, the absolute e.m.f. induced by a change in the flux will be at any instant

$$\bar{E} = N \frac{d\phi}{dt} \text{ abvolts} \quad (15a)$$

15. Lenz's Law.—Inspection of Fig. 11 shows that when the wire ab is moved to the right by the external force f' , the induced current has such a direction that its reaction against the magnetic field produces an opposing force $f = f'$. Moreover, the current is so directed that it tends to produce a magnetic field directed upward, in opposition to the inducing field H , and as the wire moves to the right in such a way as to enclose more and more flux in the circuit, the effect of the current is to oppose this increase. In other words, *the induced current opposes the action which produces it.* This is known as Lenz's law.

Since the induced current and, therefore, also the induced e.m.f. oppose the inducing action, it follows that a positive increment of flux should be regarded as producing a negative e.m.f. Consequently equation (15a) should be written

$$\bar{E} = -N \frac{d\phi}{dt} \text{ abvolts} \quad (16)$$

16. Practical Units of Current and E.M.F.—The practical unit in which the strength of a current is expressed is the *ampere*, which has such magnitude that 10 amperes are equivalent to 1 abampere.

The practical unit of e.m.f., called the *volt*, is taken 10^8 times as large as the absolute unit, the abvolt, since the latter is inconveniently small; that is, 10^8 abvolts are equivalent to 1 volt. Hence, from equation (16)

$$E = -N \frac{d\phi}{dt} \times 10^{-8} \text{ volts} \quad (17)$$

Since the power in a direct-current circuit is

$$P = \bar{E}\bar{I} \text{ ergs per second}$$

when \bar{E} and \bar{I} are expressed in abvolts and abamperes, respectively, this expression becomes

$$P = (E \times 10^8) \left(\frac{I}{10} \right) = EI \times 10^7 \text{ ergs per second}$$

when E and I are expressed in volts and amperes, respectively. But 10^7 ergs per second are equivalent to 1 *watt*, so that

$$P = EI \text{ watts}$$

17. Heating Due to a Current.—*The Joule.*—When a current of I amperes flows through a resistance of R ohms, the difference of electrical potential between the terminals of the resistor is E volts, such that $I = E/R$, or $E = IR$, in accordance with Ohm's law. Multiplying both sides of the last equation by I , there results

$$P = EI = I^2R \text{ watts, or } I^2R \times 10^7 \text{ ergs per second}$$

which represents the power absorbed in the resistance R . In a time t seconds the energy supplied to the circuit is

$$W = Pt = I^2Rt \times 10^7 \text{ ergs}$$

and this energy reappears as heat in the resistor. Since 10^7 ergs

are equivalent to 1 joule, and 1 joule per second is equivalent to 1 watt, the above expressions can be written

$$\left. \begin{aligned} W &= I^2 R t && \text{joules} \\ P &= EI = I^2 R && \text{watts} \end{aligned} \right\} \quad (18)$$

The heating effect of a current flowing through a resistor can be readily calculated when it is remembered that the mechanical (Joule's) equivalent of heat is 4.19 joules in the metric system; that is, 4.19 joules, or 4.19×10^7 ergs of work are required to raise the temperature of 1 gram of water 1°C .

18. Field Intensity Due to a Circular Coil.—Let P , Fig. 12, represent a unit magnet pole on the axis of a plane circular coil of N turns and radius r cm. Let P be x cm. from the plane of the coil, and let the current in the latter be \bar{I} abamperes. Then the force acting on an element dl of the coil is, by equation (8),

$$df = \frac{1}{r^2 + x^2} N \bar{I} dl$$

acting in the direction indicated in the figure; and the pole is acted upon by an equal force in the opposite direction.¹ Resolving

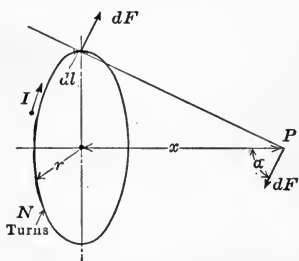

FIG. 12.—Field intensity on axis of coil.

ing this force into components respectively parallel to, and perpendicular to, the axis of the coil, it will be clear that the sum of all the perpendicular components is zero since for each element of the coil which gives rise to a perpendicular component of force in one direction, there is a diametrically opposite element which produces an equal and opposite component.

The axial component of df is

$$dH = \frac{N \bar{I} dl}{r^2 + x^2} \cos \alpha = \frac{N r \bar{I} dl}{(r^2 + x^2)^{3/2}}$$

¹ A positive magnet pole in the field produced by a current will tend to move along the lines of force that are produced by, and link with, the current. The direction of these lines can be easily found by the following rule: Grasp the wire with the right hand, with the thumb in the direction of the current flow. The fingers will then point in the direction of the lines of force.

Hence

$$H = \frac{N\bar{I}r}{(r^2 + x^2)^{3/2}} \int_0^{2\pi r} dl = \frac{2\pi N\bar{I}r^2}{(r^2 + x^2)^{3/2}} = \frac{2\pi NIr^2}{10(r^2 + x^2)^{3/2}} \quad (19)$$

At the center of the coil, where $x = 0$,

$$H = H_0 = \frac{2\pi N\bar{I}}{r} = \frac{2\pi NI}{10r} \quad (20)$$

from which it follows that the absolute unit of current (abampere) may be defined as that current which, when flowing in a circular coil of one turn and 1 cm. radius, will act upon a unit magnet pole at the center with a force of 2π dynes.

19. Field Intensity on the Axis of a Solenoid.—Let Fig. 13 represent a solenoid of N turns uniformly distributed over the length l cm. It is desired to find the field intensity at a point P on the axis, distant D cm. from the center of the solenoid.

Consider an elementary section of the solenoid dx , distant x cm. from P . The element may be considered as a plane circular coil of $\frac{N}{l}dx$ turns; the field intensity due to this elementary ring at the point P is, by equation (19),

$$dH = \frac{2\pi \left(\frac{N}{l}dx\right) Ir^2}{10(r^2 + x^2)^{3/2}}$$

and the total field intensity is then

$$H = \frac{2\pi NIr^2}{10l} \int_{-(\frac{l}{2} - D)}^{\frac{l}{2} + D} \frac{dx}{(r^2 + x^2)^{3/2}} \\ = \frac{2\pi NI}{10l} \left[\frac{\frac{l}{2} + D}{\sqrt{r^2 + \left(\frac{l}{2} + D\right)^2}} + \frac{\frac{l}{2} - D}{\sqrt{r^2 + \left(\frac{l}{2} - D\right)^2}} \right] \quad (21)$$

At the center of the solenoid, where $D = 0$, this becomes

$$H_0 = \frac{2\pi NI}{10\sqrt{r^2 + \frac{l^2}{4}}}$$

which reduces to

$$H_0 = \frac{4\pi NI}{10l} \tag{22}$$

if l is large compared with r .

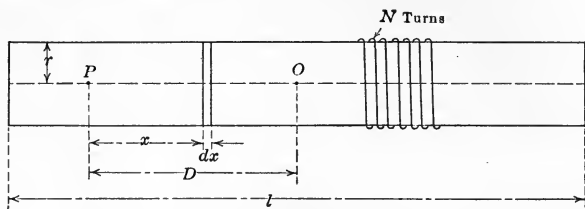

FIG. 13.—Field intensity on axis of solenoid.

At the ends of the solenoid, where $D = \frac{l}{2}$,

$$H = H_e = \frac{2\pi NI}{10l}$$

or half as great as at the center, provided l is large compared with r .

Fig. 14 shows the variation of H along the axis of a solenoid whose length is twenty-five times its radius, *i.e.*, $\frac{r}{l} = 0.04$. The

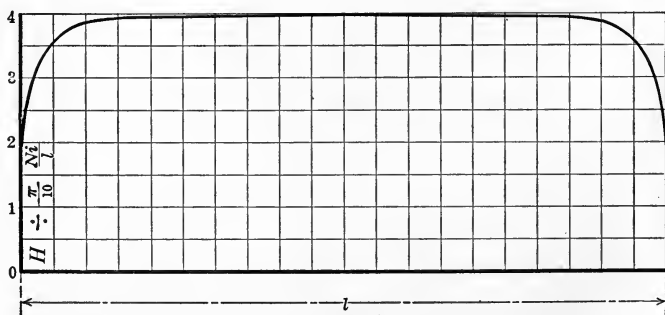

FIG. 14.—Variation of field intensity along axis of solenoid.

value of H_0 is a trifle less than $\frac{4\pi NI}{10l}$, namely, $\frac{3.9872\pi NI}{10l}$; and $H_e = \frac{1.9984\pi NI}{10l}$ instead of $\frac{2\pi NI}{10l}$. It will be observed that H is very nearly constant over the greater part of the axis, and that it falls off abruptly near the ends.

The physical interpretation of these facts concerning the variation of H along the axis is as follows: For some distance on either side of the middle section of the solenoid the lines of force inside the winding are nearly parallel, hence the field is nearly uniform and H will be practically constant; near the ends of the solenoid the lines diverge in the manner indicated in Fig. 18, and the greater the divergence the more rapidly will H decrease.

20. Magnetic Potential on the Axis of a Circular Coil.—It has been shown in Art. 18 that the field intensity on the axis of a circular coil, at any distance x from the plane of the coil, is given by

$$H = \frac{2\pi N\bar{I}r^2}{(r^2 + x^2)^{3/2}}$$

this being the force in dynes that would act upon a unit magnet pole placed at the point. With the current flowing as indicated in Fig. 15, the unit (positive) pole would be urged to the left, or toward the coil. To move the pole to the right over a distance dx there must be expended

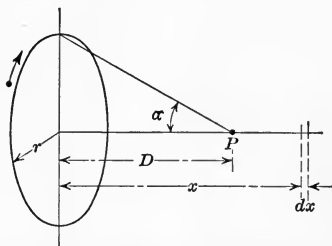

FIG. 15.—Magnetic potential on axis of circular coil.

$$dV = Hdx = \frac{2\pi N\bar{I}r^2 dx}{(r^2 + x^2)^{3/2}} \text{ ergs}$$

of work, and the total work required to move the unit pole out to infinity from a point distant D cm. from the coil is

$$\begin{aligned} V &= 2\pi N\bar{I}r^2 \int_D^\infty \frac{dx}{(r^2 + x^2)^{3/2}} = 2\pi N\bar{I} \left(1 - \frac{D}{\sqrt{r^2 + D^2}} \right) \\ &= 2\pi N\bar{I}(1 - \cos \alpha) \end{aligned} \quad (23)$$

where α is the semi-angle of the right cone subtended at the point P by the coil. But $2\pi(1 - \cos \alpha) = \omega$ is the solid angle at the vertex of the cone, hence

$$V = \omega NI \quad (24)$$

If the test pole had been of strength m units, the work done would have been m times as great as the above amount, or

$$V_m = \omega m NI \quad (25)$$

The expression V , equation (24), is the magnetic potential at a general point on the axis of the coil; it represents the work required to move a unit pole from the point out to an infinite distance, when the current flow is as indicated. If the current is reversed, V becomes the work required to bring the unit pole from an infinite distance up to the point in question.

21. General Expression for the Magnetic Potential Due to a Coil of any Shape at any Point.—Equation (25) can be put into a more convenient form, as follows: The total flux emanating from a pole of strength m units is

$$\Phi = 4\pi m \text{ maxwells}$$

hence

$$\omega m = \frac{\omega}{4\pi} \Phi = \varphi$$

represents that part of the total flux due to the pole m that passes through, or links with, the N turns of the coil. Therefore,

$$V_m = \varphi N \bar{I} = \lambda \bar{I} \text{ ergs} \quad (26)$$

where $\lambda = \varphi N$, the product of the flux and the number of turns with which it links, is called the number of *flux linkages*. Or, in other words, the potential energy of a current in a magnetic field produced by some other agency is the product of the current (in abamperes) and the number of flux linkages.

The above expression for the potential energy of a magnet pole in the presence of a current was derived by assuming a circular coil and allowing the magnet pole to move along the axis of the coil. It can be shown, however, that the resulting equations (24) and (25) are general. For let Fig. 16 represent a coil of any shape which may or may not be plane, and let ω represent the solid angle subtended by it at a point pole m placed

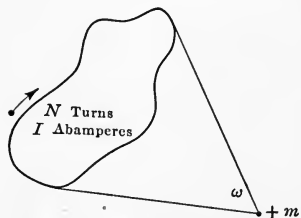

FIG. 16.—Magnetic potential due to coil of any shape.

in any general position. Then the flux emanating from m and linking the coil is

$$\varphi = \omega m \text{ maxwells}$$

Now allow the pole to move in such a manner that the solid angle

changes in magnitude by $d\omega$ in a time dt . The flux linked with the coil will change by

$$d\phi = m d\omega$$

and there will be induced in the coil an e.m.f.

$$\bar{E} = -N \frac{d\phi}{dt} \text{ abvolts}$$

If this change of flux occurs while a current of \bar{I} abamperes is flowing in the coil, the work done is given by

$$dV = -\bar{E}\bar{I}dt = N\bar{I}d\phi = mN\bar{I} d\omega \text{ ergs}$$

and the total work required to bring the pole from an infinite distance ($\omega = 0$) to a point near the coil ($\omega = \omega'$) is

$$V = mN\bar{I} \int_0^{\omega'} d\omega = m\omega'N\bar{I} = \phi N\bar{I} = \lambda\bar{I}$$

or the same as equations (25) and (26).

22. Magnetomotive Force.—Let Fig. 17 represent the side and front elevations of a plane coil of any configuration, carrying a current of \bar{I} abamperes, and let a unit magnet pole be placed at a point P in the plane of the coil but outside its boundary.

None of the flux emanating from the pole will pass through the coil, and therefore the magnetic potential at P is zero. Now let the unit pole be carried along any path to a point Q infinitely close to the plane of the coil. The solid angle subtended at Q by the coil is

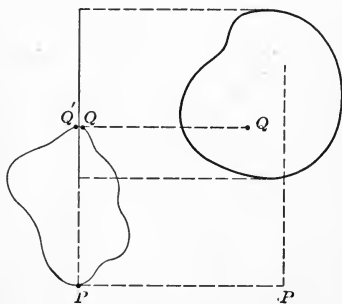

FIG. 17.—Closed path linking with coil.

2π , the magnetic potential at Q is then $2\pi N\bar{I}$, and the difference of magnetic potential between P and Q , that is, the amount of work required to carry the pole from P to Q , is $2\pi N\bar{I}$ ergs. If the pole is now carried back to P along any path which requires the pole to be threaded completely through the coil, as $Q'P$, a further amount of work equal to $2\pi N\bar{I}$ ergs must be expended, making a total of $4\pi N\bar{I}$ ergs to carry the pole once around a closed path linking with the coil. This is called the magnetomotive force (m.m.f.) of the coil. The unit of m.m.f. is called the gilbert.

It should be particularly noted that m.m.f. is not a *force*; it is of the nature of *work per unit magnet pole*. It is exactly analogous to e.m.f., which is likewise not a force, but work per unit of electrical quantity (see Art. 14).

If the coil of Fig. 12 is pulled out into the form of the solenoid of Fig. 18, the work required to carry a unit magnet pole around a closed path threading through all of the N turns is

$$4\pi NI = \frac{4\pi}{10} NI$$

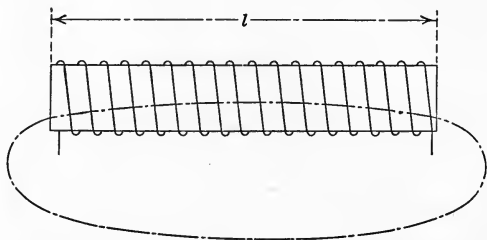

FIG. 18.—Magnetic path linking solenoid.

But the field intensity at the middle point of the axis of the solenoid is

$$H_0 = \frac{4\pi}{10} \frac{NI}{l}$$

so that

$$H_0 l = \frac{4\pi}{10} NI = \text{m.m.f.}$$

which means that if the field intensity were constant all along the axis, the work required to carry the unit pole from end to end of the solenoid would be

$$\text{force} \times \text{distance} = H_0 l = \frac{4\pi}{10} NI$$

However, the field intensity is not constant along the axis, so that the total amount of work to describe the complete path of Fig. 18 is

$$\frac{4\pi}{10} NI = \int H dl \quad (27)$$

which states that the *m.m.f.* is the *line integral of the magnetic force*.

It is interesting to note that the area under the curve of Fig. 14 represents the work required to carry a unit magnet pole through the solenoid from one end to the other, while the area of the rectangle enclosing the curve represents the work required to carry the unit pole once around a closed path linking all the turns of the solenoid. It follows, therefore, that the area above the curve, but inside the rectangle, represents to the same scale the work required to carry the magnet pole along the path from end to end of the solenoid, but outside of its windings.

23. Permeability.—The field intensity at the center of the solenoid of Fig. 13 is

$$H = \frac{4\pi}{10} \frac{NI}{l} \text{ gaussess}$$

and if the lines of force passed straight through the solenoid parallel to the axis, and were uniformly distributed over the area of cross-section A , the flux across any section would be

$$\phi = AH = \frac{4\pi}{10} \frac{NI}{l} A \text{ maxwells}$$

Now let the solenoid be provided with an iron core of length l cm. and cross-section A sq. cm., as in Fig. 19; induced poles of

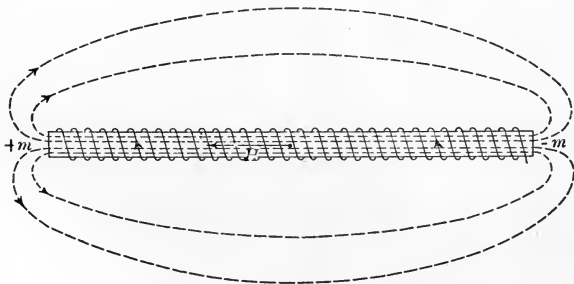

FIG. 19.—Solenoid wound on iron core.

strengths $+m$ and $-m$ will then be developed at the ends of the bar, and each of these poles will give rise to a field intensity at the center of the solenoid equal to $\frac{m}{(l/2)^2}$ and opposite in direction to

H . The resultant field intensity at the center is then

$$H = \frac{4\pi}{10} \frac{NI}{l} - \frac{2m}{(l/2)^2} = \frac{4\pi}{10} \frac{NI}{l} - \frac{8m}{l^2} \quad (28)$$

In other words, the induced poles exert a demagnetizing effect upon the field which produces them. This demagnetizing or "end effect" becomes negligibly small if the solenoid and core are long, and will be neglected in the remainder of this discussion.

From the pole $+m$ there will emanate $4\pi m$ lines of force, all of which find their way back to the pole $-m$ through the surrounding air. These lines of force may be assumed to be continued through the iron core back to the starting point, not as lines of force, but as *lines of induction*, since the former exist only in the external non-magnetic medium. Inside the iron, therefore, the total flux consists of the original HA lines of force and the $4\pi m$ lines of induction, or

$$\Phi = AH + 4\pi m$$

Assuming the flux Φ to be uniformly distributed over the cross-section A , the *flux density* is

$$B = \frac{\Phi}{A} = H + 4\pi \frac{m}{A} = H \left(1 + 4\pi \frac{m}{AH} \right) = \mu H \quad (29)$$

where

$$\mu = \frac{B}{H} = 1 + 4\pi \frac{m}{AH} \quad (30)$$

is called the *permeability* of the material of the core. It is the ratio of the flux density in the material to the intensity of the inducing field, and is therefore a measure of the specific magnetic conductance of the material. Its magnitude is dependent upon the ratio $\frac{m}{AH}$ or $\frac{m}{H}$, that is, the ratio of the strength of the induced pole to the intensity of the inducing field. The better the material from a magnetic standpoint, or the more it is susceptible to magnetization, the greater will be the strength of the induced pole for a given inducing field, hence the ratio $\frac{m}{AH}$ is called the *susceptibility*.

There is no known relation between m and H , so that it is impossible to express either μ or B in terms of H . The relation must be found experimentally for each material. Curves showing the relation between B and H are called normal B - H curves, or magnetization curves. Fig. 20 shows a number of such curves as used in practice, for several different kinds of iron and steel.

In certain kinds of iron the permeability μ reaches very large values—2000 to 3000—but its value varies as H varies, even in one and the same material. In paramagnetic substances like iron, nickel and cobalt, μ is always greater than unity; in air and other non-magnetic substances, $\mu = 1$; and in diamagnetic substances, μ is less than unity.

In the equation $H = \frac{4\pi NI}{10 l}$, the term NI represents the number

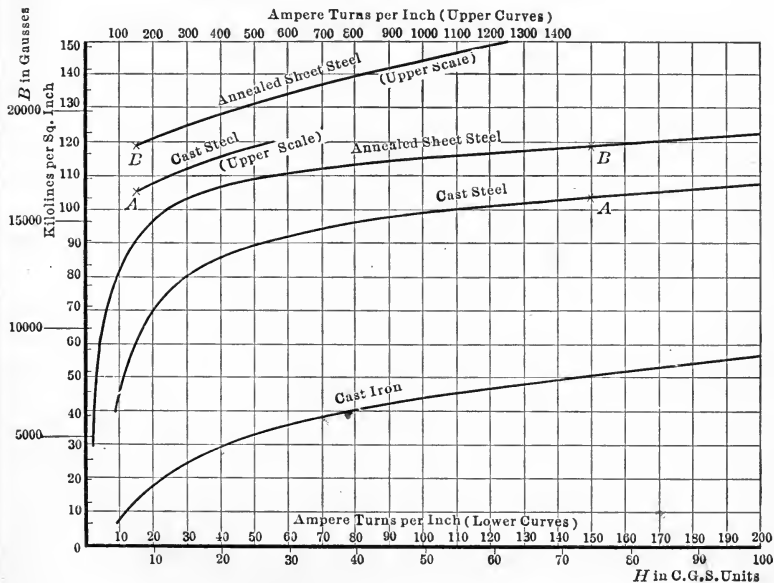

FIG. 20.—Magnetization curves.

of *ampere-turns* of the exciting winding, and NI/l expresses the number of ampere-turns per cm. It follows that

$$\text{ampere-turns per cm.} = \frac{NI}{l} = \frac{10}{4\pi}H = 0.8H$$

In practical calculations it is more convenient to deal with ampere-turns per cm. than with H , for if the value of the former quantity, corresponding to a given value of B , can be found, the total excitation (in ampere-turns) is simply the product of ampere turns per cm. and the length of the circuit. Consequently, magnetization curves are commonly drawn with B (lines per sq.

cm.) as ordinates and with $0.8H$ ($=$ ampere-turns per cm.) as abscissas. If English units are employed, the curves are drawn with ordinates $B \times (2.54)^2$ ($=$ lines per sq. in.), and with abscissas $2.54 \times 0.8H$ ($=$ ampere-turns per inch).

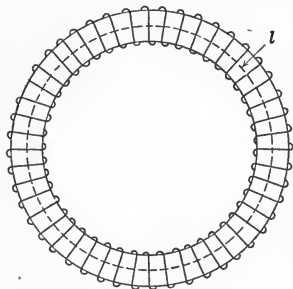

FIG. 21.—Ring core.

24. The Law of the Magnetic Circuit.—*Magnetic Reluctance.*—The demagnetizing effect of the ends of the core of Fig. 19, referred to in the preceding section, can be eliminated by bending the core into a closed ring form, as in Fig. 21. The value of H will then be uniform around the entire circular axis of the coil, and will be

$$H = \frac{4\pi NI}{10 l}$$

where l is the mean length of the core in centimeters. The total flux through the core will then be

$$\Phi = AB = A\mu H = \frac{4\pi NI}{10 l} \mu A$$

or

$$\Phi = \frac{\frac{4\pi NI}{10}}{\frac{l}{\mu A}} \quad (31)$$

The numerator of equation (31) is the m.m.f. of the solenoid, and the denominator is the *reluctance* of the magnetic circuit. It will be noted that the expression for reluctance is of the same form as that for the resistance of an electrical circuit, for it is proportional to the length and inversely proportional to the cross-section; moreover, the permeability μ appears in the expression for the reluctance in exactly the same manner as does the specific conductance in the expression for electrical resistance, hence the reference to permeability (Art. 23) as “specific magnetic conductance.” The unit in which reluctance is measured is called the *oersted*.

Equation (31) is of the form

$$\text{flux} = \frac{\text{m.m.f.}}{\text{reluctance}}$$

or, in terms of the units themselves,

$$\text{maxwells} = \frac{\text{gilberts}}{\text{oersteds}}$$

which corresponds term by term with Ohm's law of the electric circuit

$$\text{current} = \frac{\text{e.m.f.}}{\text{resistance}}$$

or

$$\text{amperes} = \frac{\text{volts}}{\text{ohms}}$$

The reciprocal of reluctance, or $\frac{\mu A}{l}$, is called *permeance*.

25. Applications of Law of Magnetic Circuit.—Magnetic circuits, like electric circuits, may be joined in *series*, in *parallel*, or in *series-parallel*, and the solution of problems involving any of these combinations is in every case carried out by methods that are the exact analogues of those used in the corresponding electrical circuits. Thus, in Fig. 22, parts *a* and *b* represent typical magnetic circuits and in each case the analogous electrical circuit is indicated. The following examples will serve to illustrate the methods to be employed in the solution of ordinary problems.

1. **SERIES CIRCUITS.**—A circuit consisting of a number of reluctances in series will have a total reluctance given by

$$\frac{l_1}{\mu_1 A_1} + \frac{l_2}{\mu_2 A_2} + \dots + \frac{l_n}{\mu_n A_n}$$

and the resultant flux through the circuit will be

$$\Phi = \frac{\frac{4\pi}{10} NI}{\frac{l_1}{\mu_1 A_1} + \frac{l_2}{\mu_2 A_2} + \dots + \frac{l_n}{\mu_n A_n}}$$

where NI is the total number of ampere-turns acting upon the circuit as a whole. This equation can be written

$$\frac{4\pi}{10} NI = \Phi \frac{l_1}{\mu_1 A_1} + \Phi \frac{l_2}{\mu_2 A_2} + \dots + \Phi \frac{l_n}{\mu_n A_n}$$

and in this form each term of the right-hand member represents the m.m.f. (in gilberts) required to maintain the flux through the corresponding portion of the circuit. The total m.m.f. is then

merely the sum of the m.m.fs. required by the individual parts. In the analogous electrical circuit

$$I = \frac{E}{R_1 + R_2 + \dots + R_n}$$

and

$$E = IR_1 + IR_2 + \dots + IR_n$$

or the total e.m.f. required to maintain the current through the circuit is the sum of the potential drops in each part of the circuit.

In most cases arising in practice it is not necessary to compute the reluctances of the several parts of a circuit in accordance with the above equations. A more direct solution is possible through the use of curves like those of Fig. 20. Thus, in Fig. 22a, let it be required to find the number of ampere-turns necessary to produce a total flux of 160,000 maxwells on the assumption that the core is made of cast iron. Assume that the mean path of the lines of force follows the center of gravity of the cross-section and that at the corners the mean path follows quadrants of circles.

$$\therefore l_1 = \text{length of path in cast iron} = 2(6 + 4) + 2\pi - 0.125 = 26.15 \text{ in.}$$

$$l_a = \text{length of path in air} = 0.125 \text{ in.}$$

$$B = \text{flux density in iron and in air-gap} = \frac{160,000}{4} = 40,000 \text{ lines per sq. in.}$$

From the curve for cast iron in Fig. 20 it is found that a flux density of 40,000 lines per sq. in. corresponds to an excitation of 79 ampere-turns per inch length of core. Hence the number of ampere-turns required by the core is $79 \times 26.15 = 2060$. The number of ampere-turns required to maintain the flux through the air-gap, where $\mu = 1$, may be found from the relation $B = H = \frac{4\pi}{10} \frac{NI}{l}$ (where all quantities are in metric units), or

$$NI = 0.8Bl = 0.3133 \times \text{lines per sq. in.} \times \text{air-gap in inches} \quad (32)$$

Hence the ampere-turns for the air-gap are

$$NI = 0.3133 \times 40,000 \times \frac{1}{8} = 1567$$

and the total excitation for the entire circuit is $2060 + 1567 = 3627$ ampere-turns.

2. PARALLEL AND SERIES-PARALLEL CIRCUITS.—In Fig. 22*b* two magnetic circuits, each of the type illustrated in Fig. 22*a*, are connected in parallel. Just as in the corresponding electrical circuit the entire battery e.m.f. acts equally on each of the parallel electric circuits, so does the entire m.m.f. of the exciting circuit act on each of the parallel magnetic circuits. In the case of the magnetic circuit of Fig. 22*b*, the flux in each part is to be computed as though the other part were not present; if the parts are exactly alike the flux will be the same in each.

Suppose, for example, that the left-hand circuit of Fig. 22*b* is exactly the same as that of Fig. 22*a*, but that the right-hand circuit, though having identical dimensions, is made of cast steel instead of cast iron. Assuming that the flux through the left-hand branch is again 160,000 maxwells, the coil must supply an excitation of 3627 ampere-turns. It does not follow that the flux through the cast-steel circuit will be 160,000 maxwells, and indeed it does not have that value because the reluctance of the cast steel is less than that of the cast iron. The problem is then to find that value of flux through the cast-steel circuit which will require 3627 ampere-turns for its maintenance. This can be done by trial, as follows:

Assume a series of values of the total flux, and for each value compute the corresponding total number of ampere-turns. Plot flux and ampere-turns, extending the computations far enough so that a curve may be drawn that will include within its range the given number of ampere-turns; the actual flux corresponding to the latter can then be read from the curve. In the case under discussion the total flux through the cast-steel circuit is in this way found to be approximately 303,200 maxwells.

In such a case as that illustrated by this particular problem, the reluctance of the cast-steel part of the circuit is so small compared with that of the air-gap that a first approximation to the final result may be found by assuming that the reluctance of the path

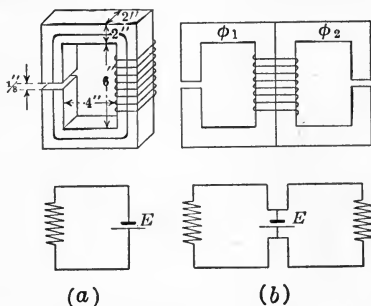

FIG. 22.—Typical magnetic and electric circuits.

through the steel is negligible, and that the entire excitation is consumed in maintaining the flux through the air-gap. On this basis the flux density in lines per sq. in. would be given by

$$3627 = 0.3133 \times B'' \times \frac{1}{8}$$

or $B'' = 92,800$ lines per sq. in. and $\Phi = 371,200$. Reference to the curves of Fig. 20 shows that at this flux density the steel would require 1635 ampere-turns, so that the entire circuit would require $3627 + 1635 = 5262$ ampere-turns, or considerably more than the available number. It is then necessary to select a smaller value of B'' , repeating the calculations until the given number of ampere-turns is included in the range of trial values.

26. Kirchhoff's Laws.—The solution of problems involving the flow of current in networks of conductors depends upon two experimental facts, known as *Kirchhoff's Laws*:

1. The algebraic sum of the currents at any junction of the conductors in the network is zero.

2. The algebraic sum of the potential drops around any closed loop in the network is zero.

The first of these two laws is a statement of the fact that the sum of all the currents *entering* a junction point is equal to the sum of all the currents *leaving* that point. If this were not so, the charge of electricity at the junction would steadily change and its potential would change correspondingly; no effect of this kind has ever been observed.

In applying the second law it is convenient to make a diagram of the network and to give to each active e.m.f. (such as that from a battery or dynamo) an appropriate symbol to indicate its magnitude and an arrow to indicate the direction in which it acts; and each conductor is to be given a symbol to indicate the magnitude of the current flowing in it, and an arrow to indicate the *assumed* direction of the current flow. Let it be agreed that the clockwise direction around any closed loop of the network shall be considered to be the positive direction through the circuit (though cases may arise when it might be more convenient to select the counter-clockwise direction as the positive one). Then any active e.m.f. that is directed positively around the loop is to be given the positive sign; it may in that case be considered to produce a *rise* of potential in the positive direction. A cur-

rent of i amperes flowing in the positive direction through a resistor of r ohms will produce a *fall* or drop of potential of ir volts, which must, accordingly, be treated as negative.

Example.—Fig. 23 represents a storage battery connected to a three-wire system, the “neutral” wire c being connected to the middle point of the battery. Each half of the battery has an e.m.f. of 115 volts, directed as shown. A and B are the loads which are supposed to consist of lamps, heaters, or other devices which do not develop a counter e.m.f., and have resistances of 6 and 8 ohms, respectively.

The outer wires, a and b , have each a resistance of 0.1 ohm, and the neutral wire c has a resistance of 0.2 ohm. Each half of the battery has a virtual internal resistance of 0.5 ohm. It is required to find the current in each of the supply lines.

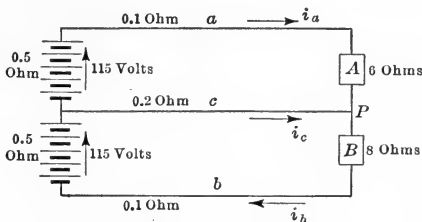

FIG. 23.—Network of conductors.

Each half of the battery has a virtual internal resistance of 0.5 ohm. It is required to find the current in each of the supply lines.

From the first law, the sum of the currents entering point P must equal the sum of the currents leaving it; hence, from the assumed directions of current flow

$$i_a + i_c = i_b$$

From the second law, referring to the upper loop of the diagram,

$$+ 115 - i_a(0.5 + 0.1 + 6) + 0.2i_c = 0$$

And referring to the lower loop

$$+ 115 - 0.2i_c - i_b(8 + 0.1 + 0.5) = 0$$

From these three independent equations it is easily found that $i_a = 17.31$, $i_b = 13.47$ and $i_c = -3.84$. The meaning of the negative sign of i_c is that that current actually flows in a direction opposite to the assumed direction.

Kirchhoff's laws are applicable to the magnetic circuit as well as the electric circuit. Thus at any junction in a magnetic circuit, the number of lines of induction coming up to the junction must be equal to the number leaving it, for the reason that

lines of induction are always closed loops. This is equivalent to Kirchhoff's first law of the electric circuit. Again, in any closed magnetic circuit, the algebraic sum of the drops of magnetic potential must be zero. If in any part of the closed magnetic circuit the flux is Φ and the reluctance R , the drop of magnetic potential is ΦR , and the summation of all such drops must then be equal to the summation of all the active m.m.fs., with due attention to the sign of each term.

27. Self-induction.—When a straight wire, Fig. 24*a*, carries a current in the direction indicated, the wire will be surrounded by magnetic lines of force as shown. As the current increases from zero to any arbitrary value, the flux will increase proportionally from zero, and may be thought of as issuing from the center of the wire and expanding outward, like spreading ripples

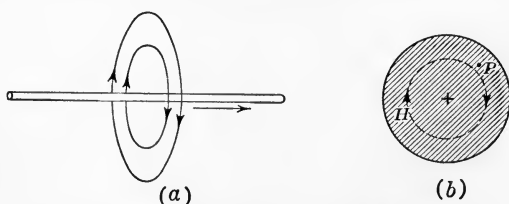

FIG. 24.—Lines of force surrounding a conductor.

on a pond. The lines of force thus expanding cut across the wire in the manner indicated in Fig. 24*b*, which represents a cross-section of the wire in (a) when viewed from the left. The expanding line of force H is about to cut across the longitudinal filament of the wire shown at P , the motion of the line of force at this point being radially outward. Relatively, the effect is the same as though the filament were moving radially inward; so that if Fleming's (right-hand) rule is applied, it is found that the induced e.m.f. is directed outward from the plane of the paper, or in opposition to the direction of the current flow. The whole effect is in accord with Lenz's law; here, however, the original change in the current strength which produced the change in the flux immediately calls into existence an opposing e.m.f. which tends to retard the change in current. Conversely, the same line of reasoning will show that an initial decrease of current induces an e.m.f. of reversed direction, which tends to main-

tain the current at its original strength. This e.m.f. being self-induced, is called the *e.m.f. of self-induction*.

Let Fig. 25 represent a coil of wire wound on a core having constant permeability μ , a cross-section of A sq. cm., and a mean length of magnetic path of l cm. The mean path is to be taken as passing through the center of gravity of the cross-section of the core. On passing a current of i amperes through the coil there will be produced a flux

$$\phi = \frac{4\pi}{10} \frac{Ni}{l} = \frac{4\pi}{10} \frac{Ni}{l} \mu A$$

and a change of current di will produce a change of flux of

$$d\phi = \frac{4\pi}{10} \frac{Ndi}{l} \mu A$$

This change of flux will then induce an e.m.f.

$$E = -N \frac{d\phi}{dt} \times 10^{-8} = -\frac{4\pi}{10} \frac{N^2 \mu A}{l} \frac{di}{dt} \times 10^{-8} = -L \frac{di}{dt} \quad (33)$$

where

$$L = \frac{4\pi}{10} \frac{N^2 \mu A}{l} \times 10^{-8} \quad (34)$$

The quantity L is called the *coefficient of self-induction* or the *self-inductance* of the circuit, and in the practical system of units is measured in terms of a unit called the *henry*. It is evident from equation (34) that the self-inductance is proportional to the square of the number of turns linked with the flux, and is dependent upon the shape, size and material of the magnetic circuit. Its magnitude is of very great importance in all electrical circuits in which the current is changing in strength, as for instance, in those coils of a direct-current generator or motor which are undergoing commutation (Chap. VIII).

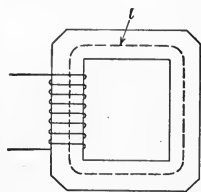

FIG. 25.—Inductive circuit.

From equation (33) it is seen that the self-inductance L of a circuit is numerically equal to the e.m.f. induced in it by a current

which is changing at the rate of 1 ampere per second ($\frac{di}{dt} = 1$); that is, a circuit has a self-inductance of 1 henry if a change of current of 1 ampere per second induces an e.m.f. of 1 volt. The self-inductance may also be defined in another way. Thus from equation (33)

$$L \frac{di}{dt} = N \frac{d\phi}{dt} \times 10^{-8}$$

or

$$L = N \frac{d\phi}{di} \times 10^{-8} \quad (35)$$

in this equation $\frac{d\phi}{di}$ is numerically equal to the rate of change of flux with current, or it is the number of lines of force produced by 1 ampere. Equation (35) says that the product of the number of lines produced by 1 ampere, multiplied by the number of turns which this flux links, and divided by 10^8 , is equal to the coefficient of self-induction. The product of flux per ampere by the number of turns with which this flux links is called the number of flux linkages per ampere, so that, briefly, *the self-inductance is equal to the number of flux linkages per ampere, divided by 10^8 .*

28. Mutual Induction.—If two circuits of N_1 and N_2 turns, respectively, are so placed with respect to each other that the magnetic field due to a current in one of these links in whole or in part with the other, a change in the current strength in the first circuit will induce an *e.m.f. of mutual induction* in the second circuit. It is clear that the magnitude of this will depend upon the geometrical shapes and relative positions of the two circuits, as well as upon the rate of change of current in the inducing circuit.

Let a current of i_1 amperes in the first circuit produce a flux Φ_1 such that

$$\Phi_1 = \frac{\frac{4\pi}{10} N_1 i_1}{\mu_1 A_1} = C_1 N_1 i_1 \quad (36)$$

A part of this flux, or

$$\phi_1 = K_1 \Phi_1 = K_1 C_1 N_1 i_1 \quad (37)$$

(where $K_1 \leq 1$) will link with the second circuit of N_2 turns, so that the total number of linkages with the second circuit is

$$\lambda_{21} = N_2\varphi_1 = K_1C_1N_1N_2i_1 \quad (38)$$

and if the second circuit is traversed by a circuit of i_2 amperes its potential energy in the presence of the first circuit is, by Art. 21,

$$V_{21} = \lambda_{21} \frac{i_2}{10} = \frac{1}{10} K_1C_1N_1N_2i_1i_2 \quad \text{ergs} \quad (39)$$

Similarly, the current i_2 in the second circuit will produce a total flux

$$\Phi_2 = \frac{\frac{4\pi}{10} N_2i_2}{\frac{l_2}{\mu_2 A_2}} = C_2N_2i_2 \quad (40)$$

of which a part

$$\varphi_2 = K_2\Phi_2 = K_2C_2N_2i_2 \quad (41)$$

(where $K_2 \leq 1$) will link with the first circuit of N_1 turns, so that the total number of linkages with the first circuit is

$$\lambda_{12} = N_1\varphi_2 = K_2C_2N_1N_2i_2 \quad (42)$$

The potential energy of the first circuit in the presence of the second is

$$V_{12} = \lambda_{12} \frac{i_1}{10} = \frac{1}{10} K_2C_2N_1N_2i_1i_2 \quad \text{ergs} \quad (43)$$

But V_{21} must be equal to V_{12} , since the potential energy of the system can have but one value;

$$\therefore K_1C_1N_1N_2 = K_2C_2N_1N_2 \quad (44)$$

From (38)

$$K_1C_1N_1N_2 = \frac{N_2\varphi_1}{i_1}$$

or it is the number of flux linkages with the second circuit due to unit current in the first circuit; and from (42)

$$K_2C_2N_1N_2 = \frac{N_1\varphi_2}{i_2}$$

which represents the number of flux linkages with the first circuit due to unit current in the second. Hence, from (44), it follows

that unit current in one circuit will produce the same number of linkages in the other, as unit current in the latter will produce in the former.

When the current in circuit No. 1 changes, the e.m.f. induced in circuit No. 2 is

$$e_2 = -N_2 \frac{d\varphi_1}{dt} \times 10^{-8} = -K_1 C_1 N_1 N_2 \frac{di_1}{dt} \times 10^{-8}$$

and when the current in circuit No. 2 changes, there will be induced in circuit No. 1 an e.m.f.

$$e_1 = -N_1 \frac{d\varphi_2}{dt} \times 10^{-8} = -K_2 C_2 N_1 N_2 \frac{di_2}{dt} \times 10^{-8}$$

From (44), these equations may be written

$$\left. \begin{aligned} e_2 &= -M \frac{di_1}{dt} \\ e_1 &= -M \frac{di_2}{dt} \end{aligned} \right\} \quad (45)$$

where

$$M = K_1 C_1 N_1 N_2 \times 10^{-8} = K_2 C_2 N_1 N_2 \times 10^{-8} \quad (46)$$

is the *number of flux linkages with one circuit due to unit current (the ampere) in the other, divided by 10^8* . This is called the *coefficient of mutual induction*, or the *mutual inductance*, of the two circuits. It is obviously of the same nature as self-inductance, and is measured in henries. From (45) it follows also that the *mutual inductance of two circuits is numerically equal to the e.m.f. induced in one of them when the current in the other changes at the rate of 1 ampere per second*.

It is clear from equation (36) that the self-inductance of circuit No. 1 is

$$L_1 = \frac{N_1 \Phi_1}{i_1} \times 10^{-8} = C_1 N_1^2 \times 10^{-8} \quad (47)$$

and from equation (40) that

$$L_2 = \frac{N_2 \Phi_2}{i_2} \times 10^{-8} = C_2 N_2^2 \times 10^{-8} \quad (48)$$

Hence, from (46), (47) and (48)

$$M^2 = K_1 K_2 L_1 L_2 \quad (49)$$

If the circuits are so related that there is no leakage of flux between them, that is, if all of the flux produced by one circuit links with all of the turns of the other,

$$K_1 = K_2 = 1$$

and

$$M = \sqrt{L_1 L_2}$$

or the mutual inductance of two perfectly coupled circuits is a mean proportional between their respective self-inductances. The factor $\sqrt{K_1 K_2}$ is sometimes called the coefficient of coupling.

The phenomenon of mutual induction is utilized in the induction coil and in the alternating-current transformer, both of which consist of an iron core upon which are wound two coils, the primary and the secondary, insulated from the core and from each other. An interrupted or alternating current in one winding sets up a periodically varying flux which in turn induces an alternating e.m.f. in the other winding. Mutual induction is also of importance as a factor in the commutation process in direct-current machines.

29. Energy Stored in a Magnetic Field.—A coil or circuit of self-inductance L henries carrying a variable current will have induced in it an e.m.f.

$$e = -L \frac{di}{dt} \text{ volts}$$

If the current is i amperes at the moment when the rate of change of current is $\frac{di}{dt}$ amperes per second, the power required to effect the change of current is

$$(-e)i = Li \frac{di}{dt} \text{ watts}$$

and the work done in the time dt is

$$dW = (-e)idt = Lidi \text{ joules}$$

The total amount of work required to raise the current from zero to a value i is, therefore,

$$W = \int_0^i Lidi = \frac{1}{2}Li^2 \text{ joules} \quad (50)$$

This energy is not lost, but is stored in the magnetic field, and may be recovered by allowing the magnetic field to collapse to

zero value. It is this energy which appears in the spark or arc formed on opening an inductive circuit.

It is instructive to compare equation (50) with the equation for the kinetic energy of a moving body. This is of the form

$$W = \frac{1}{2} mv^2$$

where m is the mass of the body and v its velocity. In the case of the electric circuit the current i is the quantity of electricity that passes a given point in a second, and is analogous to velocity. The self-inductance L represents a sort of electrical inertia, since it operates to resist any change in the current flow, or electrical velocity; it is therefore analogous to the mass of a mechanical system. The energy $\frac{1}{2}Li^2$ may, therefore, be considered as the kinetic energy of electricity in motion.

When two circuits of self-inductances L_1 and L_2 have a mutual inductance M , there is stored in the system an amount of energy equal to

$$W = \frac{1}{2}L_1i_1^2 + \frac{1}{2}L_2i_2^2 + Mi_1i_2 \text{ joules} \quad (51)$$

provided the two currents magnetize in the same direction. The derivation of the first two terms of equation (51) is obvious from (50); the last term, Mi_1i_2 , can be derived as follows:

The potential energy of one circuit in the presence of the other is from (39) and (43)

$$W = \frac{1}{10} K_1C_1N_1N_2i_1i_2 = \frac{1}{10} K_2C_2N_1N_2i_1i_2 \text{ ergs}$$

and by (46) this becomes

$$\begin{aligned} W &= \frac{1}{10}(M \times 10^8)i_1i_2 = Mi_1i_2 \times 10^7 \text{ ergs} \\ &= Mi_1i_2 \text{ joules} \end{aligned}$$

If the two circuits magnetize in opposite directions, their mutual potential energy is evidently reversed in sign, so that the stored energy of the system is

$$W = \frac{1}{2}L_1i_1^2 + \frac{1}{2}L_2i_2^2 - Mi_1i_2 \quad (52)$$

30. Tractive Effort of Electromagnets.—Let a unit magnet pole be placed at the point P , Fig. 26, on the axis of a cylindrical bar magnet of radius r cm., and distant a cm. from the end of the bar magnet; let the strength of the pole of the magnet be m units, assumed to be uniformly distributed over the end surface of the

cylinder. The pole strength per unit area, or the *intensity of magnetization*, is then

$$\sigma = \frac{m}{\pi r^2} = \frac{m}{A} \tag{53}$$

Considering an annular element of radius x and width dx on the end surface of the magnet, the force which it will exert upon the unit pole at P is

$$dF = \frac{2\pi\sigma x dx}{a^2 + x^2} \cdot \frac{a}{\sqrt{a^2 + x^2}}$$

and the total force due to the entire pole of the magnet is

$$F = 2\pi\sigma a \int_0^r \frac{x dx}{(a^2 + x^2)^{3/2}} = 2\pi\sigma(1 - \cos \theta) \tag{54}$$

where θ is the semi-angle of the right cone subtended at the point P by the end of the magnet. If the distance a is made very small,

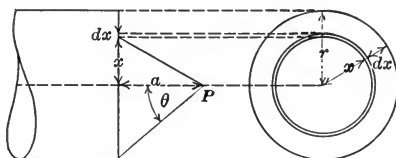

FIG. 26.—Field intensity on axis of bar magnet.

or if a is small relatively to the dimensions of the end area of the magnet, $\cos \theta$ approaches zero as a limit, in which case

$$F = 2\pi\sigma \tag{55}$$

If two bar magnets are placed end to end with a very small separation, and if the intensities of magnetization of the adjacent surfaces are $+\sigma$ and $-\sigma$, respectively, the attraction of one of the magnets upon an elementary magnet pole of area dA on the other will be $dF = 2\pi\sigma \times \sigma dA$; and the total attraction between adjacent poles will be

$$F = 2\pi\sigma^2 A \text{ dynes} \tag{56}$$

From equation (53), $\sigma = \frac{m}{A}$; and since the flux issuing from a pole of m units is $\Phi = 4\pi m$, it follows that $\sigma = \frac{\Phi}{4\pi A}$; whence, from (56),

$$F = \frac{\Phi^2}{8\pi A} = \frac{B^2 A}{8\pi} \text{ dynes} \tag{57}$$

This is the fundamental equation underlying the design of attractive or lifting electromagnets.

PROBLEMS

1. A circular coil 20 cm. in diam. is placed in a vertical plane that makes an angle of 45 deg. with the plane of the magnetic meridian. If the total intensity of the earth's magnetic field is 0.42 gauss and the angle of dip is 62 deg., what is the total flux that passes through the coil?

2. Two identical slender bar magnets, *A* and *B*, each 20 cm. long and having concentrated poles of 200 c.g.s. units at their ends, are placed with their axes in the same horizontal straight line, the south pole of *A* being adjacent to, and 5 cm. distant from, the north pole of *B*. Find the force exerted by one magnet on the other, and indicate its direction.

3. How much work must be done to turn magnet *B* of Problem 2 through 90 deg. about a vertical axis passing through its middle point? How much work must be done to turn magnet *B* through 180 deg.?

4. A trolley feeder running in an east and west direction, and carried on poles 100 ft. apart, carries a continuous current of 300 amp., flowing from east to west. If the intensity of the earth's magnetic field has the value given in Problem 1, what is the force on a length of the feeder between poles? What is its direction?

5. A storage battery having a short-time discharge rating of 10,000 amp. is connected to the switchboard by copper bus-bars which have a cross-section of 1 in. by 10 in.; the bus-bars are spaced 6 in. center to center, the 10-in. faces being placed in parallel vertical planes. Assuming that the current may be considered to be concentrated at the center of cross-section, what must be the distance between supporting brackets in order that the bus-bars may not deflect more than $\frac{1}{4}$ in.?

6. Solve the preceding problem on the assumption that the current in each bus-bar flows uniformly along the vertical plane through the central axis.

7. A horizontal wire 30 cm. long falls freely between frictionless guides that lie in a plane perpendicular to the magnetic meridian plane. The acceleration of gravity is 980 cm. per sec. per sec. and the intensity and direction of the earth's magnetic field are as given in Problem 1. What is the difference of potential between the ends of the wire at the end of the third second of its fall?

8. A concentrated circular coil of 10 turns and radius 10 cm. is revolved on a horizontal axis pointing east and west at the rate of 10 rev. per sec. (a) What is the average e.m.f. generated in the coil if the intensity and direction of the earth's magnetic field have the values given in Problem 1? (b) What is the maximum e.m.f. generated in the coil, and what is the position of the coil when the e.m.f. has its maximum value?

9. A coil of insulated wire having a resistance of 200 ohms and carrying a current is mounted in a glass tube through which is passed a stream of

water at the rate of 500 cu. cm. per min. The temperature of the surrounding air is 30° C., and the initial temperature of the water is 20° C. The current is then adjusted until the temperature of the outflowing water is constant at 40° C. What is the strength of the current?

10. A rectangular coil 30 cm. by 60 cm. and having a single turn is placed in the magnetic meridian plane with its 60 cm. sides horizontal. Parallel to it, and 40 cm. distant, there is placed a circular coil of one turn having a radius of 25 cm., the centers of both coils lying on a line perpendicular to their planes. Midway between them and on the line joining their centers is placed a small compass needle. If a current of 10 amp. flows in the rectangular coil, how much current must flow through the circular coil in order that the compass needle may not be deflected? What must be the relative directions of the currents in the two coils?

11. A slender bar magnet 20 cm. long having concentrated poles of 200 c.g.s. units at its ends is placed on the axis of a one turn circular coil of radius 25 cm. The north pole of the magnet lies nearest to the plane of the coil and is originally 10 cm. away from it. The coil carries a current of 20 amp. flowing in a counter-clockwise direction when viewed from the magnet. How much work must be done to carry the bar magnet along the axis to a symmetrical position on the other side of the coil?

12. A circular coil of 10 turns and radius of 20 cm., carrying a current of 10 amp., is placed so that its plane lies in the magnetic meridian. The intensity and direction of the earth's magnetic field being as specified in Problem 1, compute the amount of work required to turn the coil through 90° deg. about a vertical axis through the center of the coil.

13. A cast-iron ring has a circular cross-section of 1 inch diameter and a mean diameter of 10 in. How many ampere-turns are required to produce a flux of 30,000 maxwells? Compute the permeability and reluctance of the ring.

14. A magnetic circuit made of sheet steel punchings is built up to the dimensions of Fig. 22*a*. The net thickness of the core is only 90 per cent. of the gross thickness because of scale and air spaces between the punchings. Find (a) the number of ampere-turns to produce a flux of 320,000 maxwells; (b) the reluctance of the sheet steel; (c) the reluctance of the air-gap; (d) the permeability of the steel.

15. Three sections of a storage battery are connected in parallel with each other and supply current to a circuit whose resistance is 2 ohms. Each section of the battery contains 24 cells, but owing to different conditions of charging, one of them has an e.m.f. of 50 volts, the second 48 volts and the third 45 volts. Their internal resistances are, respectively, 0.1, 0.12 and 0.15 ohm. Find the current supplied by each section of the battery. What current would flow through each section if the external circuit were disconnected?

16. Compute the self-inductance of the cast-iron ring of Problem 13 assuming that the winding has 500 turns. If the current has such a value that it produces a total flux of 30,000 maxwells, what e.m.f. would be induced if the current and flux are reduced to zero, at a uniform rate, in 0.01 sec.?

17. Two circular coils, A and B , are mounted concentrically, one inside the other. A current in A produces a flux of which 70 per cent. links with B ; and a current in B produces a flux of which 90 per cent. links with A . When the two coils are connected in series so that they magnetize in the same direction the self-inductance is found to be 0.3 henry; when they magnetize in opposite directions the self-inductance is 0.05 henry. Find (a) the self-inductance of A and B ; (b) the mutual inductance of A and B ; (c) the amount of work required to turn coil B through 180 deg., starting from the position in which the two coils magnetize in the same direction, assuming that they are connected in series and are carrying a current of 50 amp.

18. If the cast-iron ring of Problem 13 is split into two semicircular parts, what is the pull, in pounds, required to separate the two halves? What is the magnitude of the pull between the two parts of the ring when they have been separated $\frac{1}{16}$ in., the excitation remaining the same as before?

CHAPTER II

THE DYNAMO

31. Dynamo, Generator and Motor.—A dynamo-electric machine, or a *dynamo*, may be defined as a machine for the conversion of mechanical energy into electrical energy, or inversely, for the conversion of electrical energy into mechanical energy. When used for the first purpose it is called a *generator*, and when used for the second it is called a *motor*. In other words, the word dynamo is a generic term which includes the other two; a dynamo is a reversible machine, being capable of operation either as generator or motor.

Every generator consists of a conductor, or set of conductors, subjected to the influence of a varying magnetic field, so that e.m.fs. are induced in them. Current will be produced when the circuit of these active conductors is completed through an external receiver circuit. On the other hand, motor action results when current from some external source is sent through a set of conductors located in a magnetic field.

In the case of generator action, each conductor is the seat of an induced e.m.f. of

$$\bar{E} = Hlv \text{ abvolts} \quad (1)$$

where l is the length of the wire in centimeters, H is the intensity of the field through which it is moving, and v is its velocity in centimeters per second in a direction perpendicular to that of the field and to its own length. On closing the circuit there will flow a current of, say, \bar{I} abamperes, the value of which will depend upon the resistance of the circuit as a whole, in accordance with Ohm's law. The conductor will then be acted upon by a force of

$$F = H\bar{I}l \text{ dynes} \quad (2)$$

in a direction opposite to its motion; hence, to maintain the action, a driving force must be applied to the conductor and work must be done at the rate of $Fv = H\bar{I}lv = \bar{E}\bar{I}$ ergs per second.

In the case of motor action, each conductor is caused to carry a current of I abamperes, so that it is acted upon by a lateral thrust of

$$F = HIl \text{ dynes}$$

motion of the wire results, and under the influence of the field intensity H and velocity v there is induced in the wire an e.m.f.

$$\bar{E} = Hlv \text{ abvolts}$$

in a direction opposite to the current. To maintain the current flow there must be impressed an e.m.f. of sufficient magnitude to balance this counter-generated e.m.f., and work is done by the electrical source of supply at the rate of $\bar{E}\bar{I} = Hlv\bar{I} = Fv$ ergs per second.

In this discussion ideal conditions have been tacitly assumed, namely, that all of the energy supplied reappears as useful energy after the conversion process has been completed. As a matter of fact this condition is never realized in practice; the energy supplied must be greater than that usefully converted by an amount equal to the loss of energy inevitable in the conversion.

The *armature* of a dynamo is the part in which the e.m.f. is generated in the case of a generator, or the part which carries the working current in the case of a motor. The *field* member is the part which produces the magnetic field. The relative motion of the one structure with respect to the other is most easily obtained by making one or the other rotate, so that in general the two have concentric cylindrical forms. Either may be the rotating member; if the armature rotates, the machine is called a revolving armature machine, while if the field rotates it is called a revolving field machine.

There are two distinct types of dynamo-electric machines, according to the nature of the e.m.f. and current produced; they are (1) *alternating-current* machines, and (2) *direct-current* machines. The first type, when used as a generator, is called an *alternator* and produces an e.m.f. which acts alternately in opposite directions, so that when the armature circuit is completed the current in the circuit flows first in one direction and then in the other. The second type produces a current through the external circuit which flows in one direction only. A direct current, though characterized by constancy of direction, may, however, vary in magnitude from

instant to instant, that is, it may be pulsating; or it may be constant in magnitude as well as in direction. In the former case, the current is said to be a *direct current*; in the latter case the current is said to be a *continuous current*.

The alternating-current generator or motor is the simplest form of dynamo. Reduced to the most elementary type, it consists of a loop of wire, *abcd*, Fig. 27, rotating in a magnetic field that passes across from pole *N* to pole *S*. It is understood that the pole pieces *N* and *S* are the extremities of the field structure, and that the excitation of the magnets is effected by a direct current from some suitable source circulating in coils wound on the field structure. The ends of the armature coil are attached to the insulated slip-rings r_1 , r_2 . In the position shown in the figure, wire *ab* will have generated in it an e.m.f. directed from

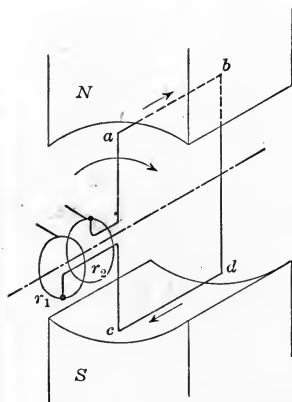

FIG. 27.—Elementary alternator.

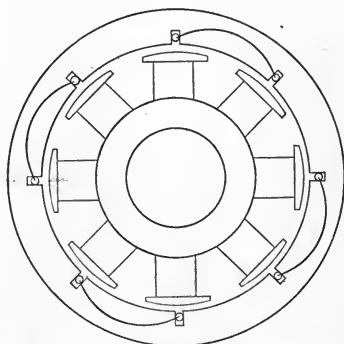

FIG. 28.—Multipolar revolving field alternator.

front to back, while the e.m.f. in *cd* will be directed from back to front; the collecting brush touching ring r_1 will therefore be positive, and that touching r_2 will be negative. After half a revolution it will be seen that the polarity of the terminals reverses, so that each terminal is alternately of opposite polarity.

In practice, alternating-current machines usually have more than the two poles shown in Fig. 27; in other words, they are *multipolar*. The winding consists of a number of coils connected in series in such manner that the e.m.fs. of the individual coils add together. Fig. 28 represents diagrammatically an 8-pole

revolving field machine with the winding of the stationary armature arranged in eight slots. Fig. 29 is a development of this particular type of winding as it would appear if the cylindrical surface of the armature were rolled out into a plane.

With the exception of the homopolar machine described in Art. 50, all standard forms of direct-current generators and

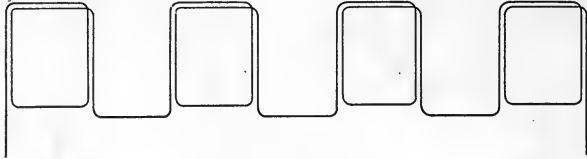

FIG. 29.—Developed armature winding of alternator of Fig. 28.

motors consist of a wire- or bar-wound armature arranged to rotate between inwardly projecting poles of alternate polarity, in the manner illustrated in Fig. 44. Each of the armature conductors is, therefore, the seat of an alternating e.m.f. which changes its direction each time the conductor moves from the influence of one pole to that of the adjacent pole. It is the function of the commutator to convert this internal alternating e.m.f. into a uni-directional e.m.f. in the external circuit; but so far as

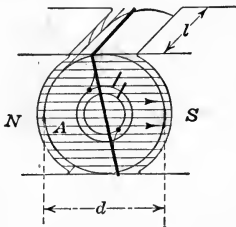

FIG. 30.—Elementary alternator.

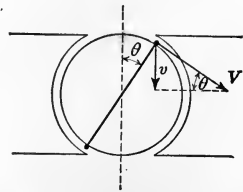

FIG. 31.—Alternator armature in a general position.

the armature winding itself is concerned, every direct-current machine (with the exception of the homopolar machine) is essentially an alternating-current machine, hence it is important to analyze the development of the e.m.f. in an alternator in order to understand thoroughly what is happening in the case of the direct-current machine.

32. E.M.F. of Elementary Alternator.—Consider first the elementary alternator of Fig. 30, whose armature winding consists

of a concentrated coil having Z conductors (or $N = \frac{Z}{2}$ turns) on the external periphery of the armature core A . Let it be assumed that the poles N, S are so shaped that the magnetic flux issuing from them passes straight across the air-gap between the pole shoes and armature core, as indicated by the light horizontal lines, and that the field in the gap is uniform and of intensity H gausses. Further, let the armature rotate with a speed of n revolutions per minute. The generated e.m.f. may then be found in either of the following ways:

(a) The peripheral velocity of the conductors is

$$V = \pi d \frac{n}{60} \text{ cm./sec.} \quad (3)$$

and at any general instant, when the coil has moved θ degrees from the vertical (Fig. 31), the component of velocity perpendicular to the direction of the flux is

$$v = V \sin \theta = \pi d \frac{n}{60} \sin \theta \quad (4)$$

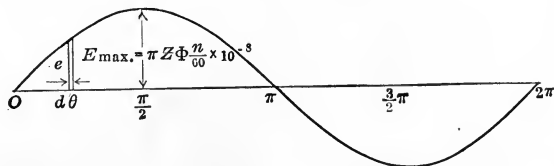

FIG. 32.—Time variation of E.M.F. of elementary alternator.

The instantaneous e.m.f. per conductor is then

$$e = Hlv \times 10^{-8} = \pi dlH \frac{n}{60} \sin \theta \times 10^{-8}$$

and for the entire Z conductors it is

$$e = \pi dlHZ \frac{n}{60} \sin \theta \times 10^{-8} \quad (5)$$

But dlH is the entire flux, Φ , that passes from pole to pole, so that

$$e = \pi Z \Phi \frac{n}{60} \sin \theta \times 10^{-8} = 2\pi N \Phi \frac{n}{60} \sin \theta \times 10^{-8} \quad (6)$$

This equation shows that the e.m.f. varies from instant to

instant according to a sine law. The graph of this equation is a sine curve whose maximum value is

$$E_{max} = \pi Z \Phi \frac{n}{60} \times 10^{-8} = 2\pi N \Phi \frac{n}{60} \times 10^{-8} \quad (7)$$

as shown in Fig. 32.

The average e.m.f. during the period from $\theta = 0$ to $\theta = \pi$, corresponding to a half revolution of the armature, is found by dividing the area of one loop of the curve of Fig. 32 by the base; or

$$\begin{aligned} E_{aver} &= \frac{1}{\pi} \int_0^{\pi} e d\theta = Z \Phi \frac{n}{60} \times 10^{-8} \int_0^{\pi} \sin \theta d\theta = 2Z \Phi \frac{n}{60} \times 10^{-8} \\ &= 4N \Phi \frac{n}{60} \times 10^{-8} \quad (8) \end{aligned}$$

(b) In the general position of Fig. 31, the flux linked with the coil is

$$\varphi = \Phi \cos \theta \quad (9)$$

hence, by equation (17), Chap. I, the instantaneous e.m.f. is

$$e = -N \frac{d\varphi}{dt} \times 10^{-8} = N \Phi \sin \theta \frac{d\theta}{dt} \times 10^{-8}.$$

But $\frac{d\theta}{dt}$ is the angular velocity, and this is equal to $2\pi \frac{n}{60}$, hence

$$e = 2\pi N \Phi \frac{n}{60} \sin \theta \times 10^{-8}$$

which is the same as equation (6) above.

(c) By definition, the average e.m.f. induced in a conductor is equal to the number of lines of force cut per second, divided by 10^8 . Now, in one revolution each conductor cuts 2Φ lines, hence the entire Z conductors cut $2\Phi Z$ lines per revolution and $2\Phi Z \frac{n}{60}$ lines per second. The average e.m.f. is therefore

$$E_{aver} = 2\Phi Z \frac{n}{60} \times 10^{-8} = 4N \Phi \frac{n}{60} \times 10^{-8}, \text{ which is identical with equation (8).}$$

33. Induced and Generated E.M.F.—In the preceding article the direction of the flux in the air-gap was assumed to be everywhere parallel to the axis of the pole pieces. This is equivalent to the assumption that the intensity of the field at each point on the periphery of the armature, in the direction of

the radius, is proportional to the sine of the angle between the particular radius considered and the axis of reference (the vertical line in Fig. 31). Such a distribution of flux is said to be sinusoidal. If the armature surface is developed into a plane, as indicated in Fig. 33, the strength of field at each point of the periphery will be represented by the ordinate of the sine curve whose maximum value, opposite the center of the pole, is H . When the coil is in the position shown by the full lines (Fig. 33), each coil edge is cutting the field at the greatest rate, and the e.m.f. generated in the conductors is a maximum. When the

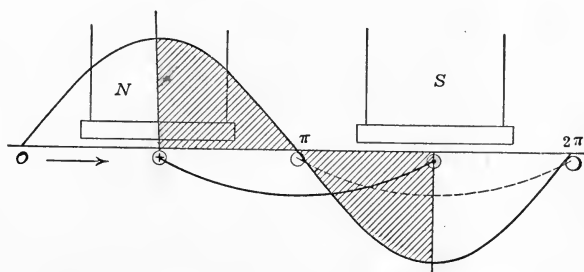

FIG. 33.—Distribution of field intensity at armature periphery.

coil has reached the dotted position, the e.m.f. is zero. It is important to note that in the first instance the total flux linked with the coil is zero, as shown by the equality of the hatched positive and negative areas; so that if the armature coil were stationary in this position, a change in the magnitude of the polar flux would not induce e.m.f. in the coil, since half of the flux acts in one direction and the other half in the opposite direction. For this reason it is advantageous to distinguish between *generated* e.m.f. and *induced* e.m.f., the former being due to the motion of a conductor across magnetic lines of force, the latter to a change in the total flux linked with a closed coil. As a further instance of the distinction between these two views of the matter, it will be noted that in the dotted position of the coil the generated e.m.f. is zero, whereas if the coil were stationary in this position the induced e.m.f., due to a given change in polar flux, would be a maximum, since all of the flux through the coil is then in the same direction.

34. General Case of the E.M.F. of an Alternator.—The discussion of Art. 32 was based upon the assumption of a bipolar field structure, a sinusoidal flux distribution, and a full-pitch armature coil, that is, a coil spanning the arc from center to center of poles. Generally, however, there is more than a single pair of poles, the flux distribution may depart considerably from the sinusoidal, and the coil spread may be greater or less than the pole pitch.

Let Fig. 34 represent a partial development of an alternator having p poles (like Fig. 28), and let the distribution of flux at

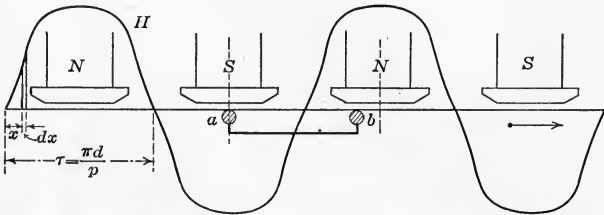

FIG. 34.—Multipolar alternator, non-sinusoidal flux distribution.

the armature surface be represented by curve H ; further, let the armature have a diameter of d cm., the conductors have an active length of l cm. in a direction parallel to the shaft, and let the speed of rotation be n revolutions per minute. The instantaneous e.m.f. generated in each conductor is

$$e = Hlv \times 10^{-8} = Hl\pi d \frac{n}{60} \times 10^{-8} \quad (10)$$

and the graph of this e.m.f. will then be a curve which is the same as that showing the flux distribution, except for a change in scale. The average e.m.f. per conductor is

$$E_{aver} = \frac{1}{\tau} \int_0^{\tau} \frac{\pi d}{p} e dx = \frac{1}{\tau} \frac{n}{60} \pi d \int_0^{\tau} H l dx \times 10^{-8} = p \frac{n}{60} \Phi \times 10^{-8} \quad (11)$$

where $\Phi = \int_0^{\tau} H l dx$ is the flux per pole. The last result might have been anticipated from the fact that the average e.m.f. is equal to the number of lines of force cut per second, divided by 10^8 ; thus each conductor in one revolution cuts Φ lines per pole,

or $p\Phi$ lines per revolution, hence $p\Phi\frac{n}{60}$ lines per second. It is interesting to note that Φ is the integral of the H function; conversely, H is the first derivative of the flux function.

If the armature is wound with Z conductors, all connected in series as in Fig. 29, in such a manner that the coils are of full pitch, the total average e.m.f. is

$$E_{aver} = p\Phi Z \frac{n}{60} \times 10^{-8} \quad (12)$$

which becomes identical with equation (8) if $p = 2$.

As pointed out above, each conductor is the seat of an e.m.f. whose variation from instant to instant is represented graphically by a curve identical (except for a change of scale) with the curve of flux distribution, Fig. 34. If the conductors are arranged as in Fig. 29 so that the coil spread is the same as the pole pitch, the e.m.f. in all conductors will be simultaneously in the same phase

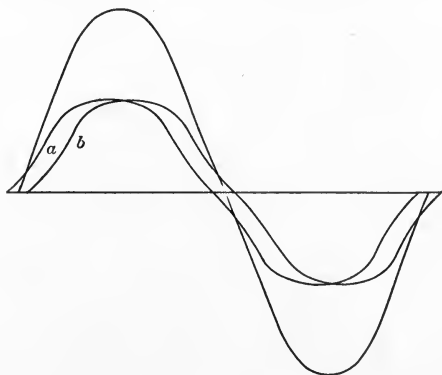

FIG. 35.—E.M.F. in coil of fractional pitch.

of the variation, and the total instantaneous e.m.f. will be simply Z times that of a single conductor. But if the coil spread differs from the pole pitch, as indicated by coil ab , Fig. 34, the instantaneous e.m.fs. of the two sides of the coil will differ in phase, that of coil-edge a following curve a , Fig. 35, and that of coil-edge b following curve b . The total instantaneous e.m.f. of the coil is obtained by adding the ordinates of the individual e.m.f. curves. It is evident from Fig. 35 that the maximum e.m.f. of such a

“short-chord” winding is less than that of a full-pitch winding of the same number of conductors.

35. Rectification of an Alternating E.M.F.—If the terminals *a* and *c* of the armature coil of the elementary alternator of Fig. 27 are connected, respectively, to the two insulated segments of a commutator *C*, as in Fig. 36, and stationary brushes, *b*₁, *b*₂, are mounted so as to make sliding contact with the revolving commutator segments, the plane of the brushes being coincident with that through the shaft and the polar axis, brushes *b*₂ and *b*₁ will always be of positive and negative polarity, respectively. The reversal of the e.m.f. of the coil takes place coincidentally with the passage of the brushes across the gaps between the segments. If, then, the flux distribution is sinusoidal, the brush voltage will vary in the manner shown in Fig. 37, that is, it will be uniform in direction, but pulsating between zero and a maximum value.

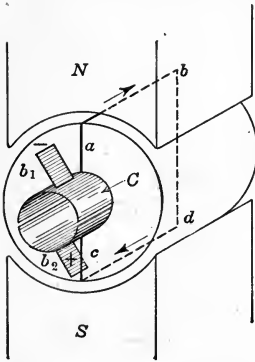

FIG. 36.—Elementary direct-current generator.

Let the *Z* peripheral conductors of the coil of Fig. 36 be wound as in Fig. 38. Here there are still *Z* peripheral conductors, but there are two coils, each having $\frac{Z}{2}$ turns, or *Z* turns in all. The part of the winding inside the ring core plays no part in generating e.m.f., since it cuts no lines of force. The windings of Figs. 36 and 38 are therefore electrically identical, and the latter will give the same pulsating e.m.f. as the former.

36. Effect of Distributed Winding.—An e.m.f. or current varying as in Fig. 37 is not desirable, and means must be found to make it more nearly continuous. The large amplitude of the pulsation of the e.m.f. in Fig. 37 is due to the fact that the entire armature winding of Figs. 36 or 38 is inactive twice during each revolution; if the winding can be so disposed that

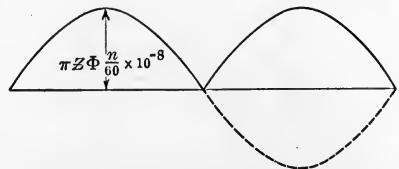

FIG. 37.—Rectification of alternating E.M.F.

be found to make it more nearly continuous. The large amplitude of the pulsation of the e.m.f. in Fig. 37 is due to the fact that the entire armature winding of Figs. 36 or 38 is inactive twice during each revolution; if the winding can be so disposed that

small sections of it undergo commutation successively, the pulsations will become insignificant when the number of such winding sections is sufficiently large. Let Fig. 39 be a diagrammatic sketch of the armature of Fig. 38, but with the Z conductors arranged in four equidistant groups of concentrated coils connected to a four part commutator. A study of the directions of the e.m.fs. generated in the coils shows that the brushes must

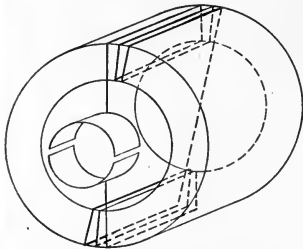

FIG. 38.—Elementary ring-wound armature.

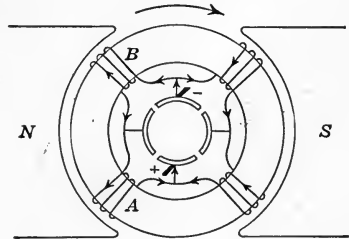

FIG. 39.—Ring winding with four sections.

now be placed in a plane perpendicular to that through the shaft and polar axis, and that the entire winding is now equivalent to two equal halves connected in parallel. Each half, in turn, is made up of a pair of winding sections connected in series. Since the winding consists of two equal halves in parallel, the voltage at the brushes is equal to that of either half alone. Considering the particular half-winding made up of sections A and B , it will be observed that section A generates a wave of e.m.f. similar to

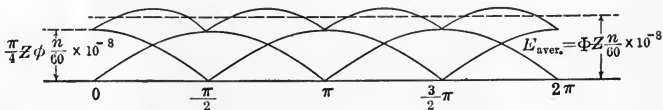

FIG. 40.—E.M.F. generated in four-coil winding.

that of Fig. 37, but of only one-fourth the amplitude since it has but one-fourth as many conductors as the coil of Fig. 38. (A sinusoidal flux distribution is assumed.) Similarly, section B generates a wave exactly like that of section A , but the two waves differ in phase by 90 deg., as shown in Fig. 40. The resultant brush voltage will be obtained by adding the ordinates of these two component curves, as shown. There are now four pulsations

instead of the original two, but the range from minimum to maximum is much reduced. The average voltage at the brushes will be

$$E_{aver} = \Phi Z \frac{n}{60} \times 10^{-8} \quad (13)$$

or one-half as great as given by equation (8) since only $Z/2$ conductors are in series.

Similarly, if the entire Z conductors are grouped in eight equidistant concentrated sections, connected to an eight-part commutator, as in Fig. 41, the winding is

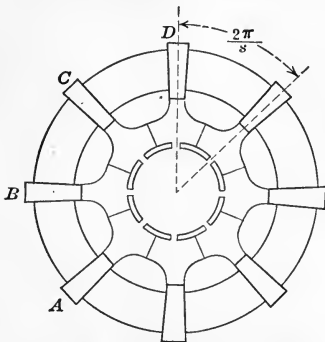

FIG. 41.—Ring winding with eight sections.

made up of two halves in parallel, each half containing four sections in series. Each of these four sections, A , B , C , D , generates a wave differing in phase by 45 deg. from its neighbor, and the maximum e.m.f. of any one section is $\frac{1}{8}\pi Z \frac{n}{60} \times 10^{-8}$. The resultant

brush voltage, as shown in Fig. 42, is made up of eight pulsations in place of the original two, and their amplitude is still less than in the case of the four-section winding.

It follows, then, that by subdividing the winding and correspondingly increasing the number of commutator segments, the amplitude of the pulsations may be reduced to any desired extent.

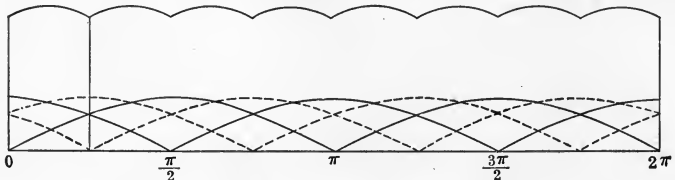

FIG. 42.—E.M.F. generated in eight-coil winding.

The physical explanation of this fact may be traced to the circumstance that the winding section cut out from the armature circuit during its passage under a brush plays a smaller and smaller part in its effect upon the total e.m.f. as the number of sections is increased.

37. Magnitude of E.M.F. Pulsations.—Assume a ring winding consisting of Z peripheral conductors divided into s sections having Z/s turns each, Fig. 41, and assume also that the magnetic field has a sinusoidal distribution. As before, let Φ be the total flux per pole and let n be the number of revolutions per minute. Each winding section will then generate a sinusoidal e.m.f. whose maximum value is $\frac{\pi}{s} \Phi Z \frac{n}{60} \times 10^{-8}$ volts. There are $s/2$ sections in series in each of the parallel paths through the armature winding, and the e.m.fs. in these sections are, respectively,

$$e_1 = \frac{\pi}{s} \Phi Z \frac{n}{60} \sin \theta \times 10^{-8} = E'_{max} \sin \theta$$

$$e_2 = E'_{max} \sin \left(\theta + \frac{2\pi}{s} \right)$$

$$e_3 = E'_{max} \sin \left(\theta + 2 \cdot \frac{2\pi}{s} \right)$$

.....

$$e_{s/2} = E'_{max} \sin \left[\theta + \left(\frac{s}{2} - 1 \right) \frac{2\pi}{s} \right] = E'_{max} \sin \left[\theta + \left(\pi - \frac{2\pi}{s} \right) \right]$$

Investigation of Figs. 40 and 42 will show that a complete pulsation occurs in an interval of $\frac{2\pi}{s}$ deg.; a minimum value of e.m.f. occurs when $\theta = 0$ and a maximum when $\theta = \frac{\pi}{s}$ deg. Substituting these values of θ in the equation

$$E = e_1 + e_2 + e_3 + \dots + e_{s/2} = E'_{max} \left\{ \sin \theta + \sin \left(\theta + \frac{2\pi}{s} \right) + \dots + \sin \left[\theta + \left(\pi - \frac{2\pi}{s} \right) \right] \right\}$$

it follows that

$$\begin{aligned} E_{min} &= E'_{max} \left[\sin \frac{2\pi}{s} + \sin \frac{4\pi}{s} + \dots + \sin \left(\pi - \frac{2\pi}{s} \right) \right] \\ &= \frac{\pi}{s} \Phi Z \frac{n}{60} \cotan \frac{\pi}{s} \times 10^{-8} \end{aligned} \tag{14}$$

$$\begin{aligned} E_{max} &= E'_{max} \left[\sin \frac{\pi}{s} + \sin \frac{3\pi}{s} + \dots + \sin \left(\pi - \frac{\pi}{s} \right) \right] \\ &= \frac{\pi}{s} \Phi Z \frac{n}{60} \operatorname{cosec} \frac{\pi}{s} \times 10^{-8} \end{aligned} \tag{15}$$

The percentage variation from minimum to maximum in terms of the minimum value, is

$$\frac{\operatorname{cosec} \frac{\pi}{s} - \cotan \frac{\pi}{s}}{\cotan \frac{\pi}{s}} \times 100$$

and the magnitude of this quantity, for various values of s , is shown in the following table:

s	Per cent. variation
2	∞
4	41.0
6	15.4
10	5.17
20	1.24
30	0.56
60	0.13

In other words, with the winding divided into 30 or more sections (the field structure being bipolar), the fluctuations are quite insignificant.

38. Average E.M.F. of an Armature.—With the type of machine premised in the foregoing article, the average e.m.f. may be found by observing that the e.m.f. varies from a minimum to a maximum value between $\theta = 0$ and $\theta = \frac{\pi}{s}$, and then decreases symmetrically to the minimum value when $\theta = \frac{2\pi}{s}$. (See Figs. 40 and 42.)

Consequently

$$\begin{aligned} E_{aver} &= \frac{1}{\pi/s} \int_0^{\pi/s} (e_1 + e_2 + e_3 + \dots + e_{s/2}) d\theta \\ &= \Phi Z \frac{n}{60} \times 10^{-8} \int_0^{\pi/s} \left\{ \sin \theta + \sin \left(\theta + \frac{2\pi}{s} \right) + \dots + \right. \\ &\quad \left. \sin \left[\theta + \left(\pi - \frac{2\pi}{s} \right) \right] \right\} d\theta \\ &= \Phi Z \frac{n}{60} \times 10^{-8} \end{aligned} \quad (16)$$

In the type of machine thus far considered there were but two poles and only two paths for the current from brush to brush

inside the armature winding. But in general the number of poles, p , may be any even integer, and the number of parallel paths through the armature may be any other even integer, a , as will be explained in detail in the chapter on armature windings (Chap. III). The average value of the generated e.m.f. in such a case may be easily calculated as follows: Each conductor cuts $p\Phi$ lines per revolution, or $p\Phi \frac{n}{60}$ lines per second, so that the average e.m.f. per conductor is $p\Phi \frac{n}{60} \times 10^{-8}$ volts; the entire number of conductors is divided into a groups connected in parallel, so that there are Z/a conductors in series per group; the e.m.f. per group of conductors, and, therefore, of the armature as a whole, is

$$E = \frac{Z}{a} p\Phi \frac{n}{60} \times 10^{-8} = \frac{p}{a} \frac{\Phi Z n}{60 \times 10^8} \quad (17)$$

This is the *general equation for the generated e.m.f. of a direct-current machine, provided* the brushes are so placed that the winding sections of any one group are simultaneously under the influence of one pole. Thus, if the brushes of the armature of Fig. 43 are so placed that commutation takes place in coils opposite the middle of the pole shoes, the potential difference between them will be zero. Each path through the armature is made up of conductors half of which are subjected to the inductive action of one pole and the other half to the influence of a pole of opposite polarity.

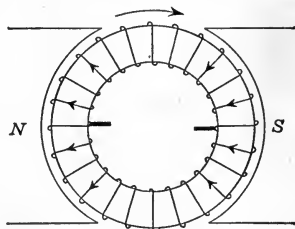

FIG. 43.—Brushes displaced from proper position.

39. Resistance of Armature Winding.—In an armature having a paths, the total armature current i_a will divide equally between them, provided all paths have the same resistance. If the total resistance of all the wire on the armature is R_a ohms, the resistance per path will then be R_a/a ohms, and since all of these a paths are connected in parallel, the actual resistance of the armature, as measured between brushes, will be $R_a/a^2 = r_a$ ohms. The drop of potential due to the entire current i_a flowing through the resistance r_a , or $i_a r_a$ volts, is, of course, equal to the drop of

potential through any one of the paths, or $i_a/a \times R_a/a = i_a r_a$ volts.

40. Construction of Dynamos.—The dynamo consists essen-

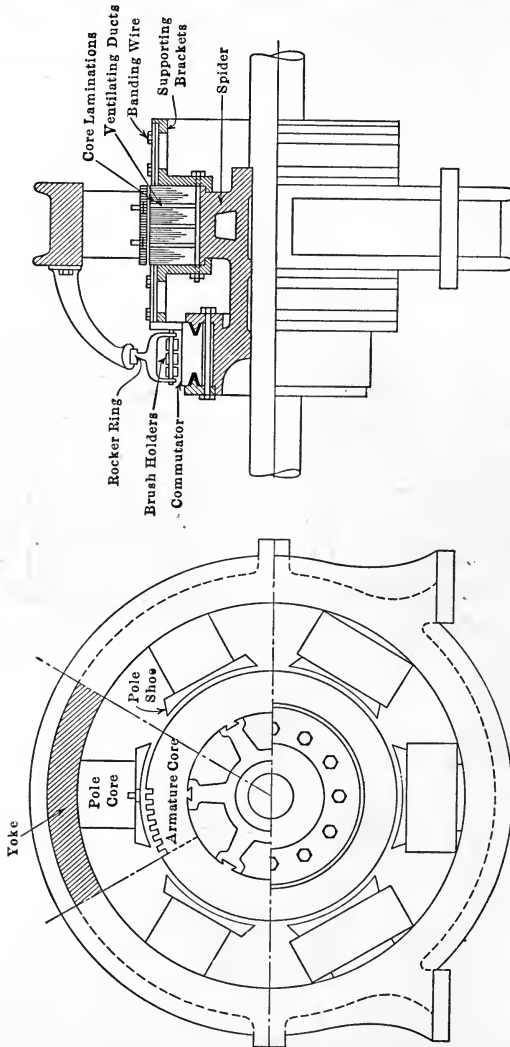

FIG. 44.—Diagrammatic view of multipolar dynamo.

tially of an electrical circuit and a magnetic circuit placed in inductive relation to each other. The electric circuit consists of the armature winding and the commutator. The magnetic

circuit is made up of the yoke, pole cores and pole shoes, and the armature core. The annular space between the revolving armature and the stationary field structure is called the air-gap. Other parts of the machine are the field winding, the brushes, brush-holders and the rocker-arm, the armature spider and the bearings. Fig. 44 shows a common arrangement of these parts in the *open type* of construction. Fig. 45 shows a *semi-enclosed type*, and Fig. 46 a *totally enclosed motor*. The principal structural features of the various parts of the machine, with the exception of the armature winding, are described in the following articles. The subject of armature windings is taken up in detail in Chap. III.



FIG. 45.—Semi-enclosed motor (Sprague).

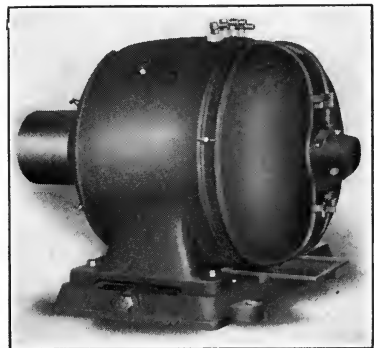

FIG. 46.—Totally enclosed motor (Sprague).

41. Bipolar and Multipolar Machines.—Although for the sake of simplicity much of the preceding discussion has been based on the assumption of a bipolar field structure, this type of field is seldom used except in machines of the smallest size. The actual number of poles generally varies from four to a maximum (in direct-current machines) of twenty to twenty-four, the number increasing with the capacity, though not at all regularly. The explanation of the principles underlying the choice of the number of poles in any given case must be deferred to a later section; in general, however, the choice of the number of poles depends upon the consideration that the magnetic reaction of the armature, when carrying current, cannot exceed definite limits without impairing the operating characteristics of the machine. Further,

with an armature core of given dimensions, and with pole pieces that cover a definite percentage of the armature surface, the field frame becomes more compact, up to a certain limit, as the number of poles is increased beyond two. The optimum limit occurs when the peripheral spread of the pole faces is approximately equal to the axial length of the pole face. A compact field frame is advantageous in that comparatively little of the field flux leaks from pole to pole without entering the armature core.

42. The Commutator.—The commutator is built up of wedge-shaped segments of drop-forged or hard-drawn copper insulated from one another by accurately gauged thin sheets of insulating

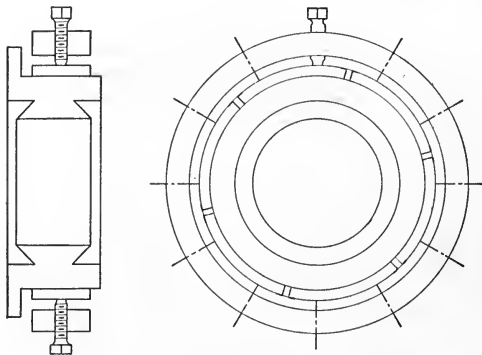

FIG. 47.—Construction of commutator.

material, such as mica. The process of assembling a large number of segments into a rigid structure is an interesting one. The segments, separated from one another by the mica insulation, are placed around the inner periphery of a sectored steel ring, as in Fig. 47, and the copper segments are then wedged together to form a rigid circular arch by means of cap-screws tapped radially through the outer steel ring. The V-shaped grooves are then turned out and the commutator spider bolted into place, after which the auxiliary steel clamping rings are removed and the external surface turned to true cylindrical form.

The insulation between the commutator and the supporting hub consists of molded mica cones and cylinders. The completed commutator must be given a high voltage test to insure the thorough insulation of each segment from the others and from the

spider. The insulation between adjacent segments does not have to be as heavy as that between the segments and the commutator spider, for the latter must withstand the full terminal voltage of the machine while the former is only called upon to withstand the smaller voltage between segments. The average voltage between adjacent segments should not exceed 10 to 15 volts in lighting and railway generators, and from 20 to 25 volts in the case of railway motors. These limiting values of average voltage between segments are imposed by the requirements of sparkless commutation, and they determine the minimum number of segments in the completed commutator. For example, if a 6-pole, 600-volt railway generator is to have not more than 10 volts between adjacent segments, there must be at least 60 segments between adjacent brushes of opposite polarity, or not less than 360 segments in the entire commutator. The minimum diameter of the commutator is then determined if the minimum peripheral width of a segment is known; this minimum width is rarely less than $\frac{3}{16}$ in. for two reasons: first, because the taper of the segments would result in too thin a section at the inner periphery if a smaller external width were used; second, because some allowance in the radial depth of the segments must be made to permit turning down the surface in case of pitting, blistering or wear. The thickness of the insulation between segments varies from 0.02 in. in low voltage machines up to about 0.06 in. in high voltage machines. The material must be so selected that its rate of wear is the same as that of the copper bars. Amber mica is largely used because it meets this requirement. Commutators are sometimes built in such manner that the insulation does not come quite flush with the surface, thereby obviating the necessity of selecting the material for a definite rate of wear.

Commutators must be designed to have a sufficient amount of exposed peripheral surface to radiate the heat caused by brush friction and the loss due to brush contact resistance. The permissible working temperature of the commutator is from 95° C. to 130° C., depending upon the current per brush arm.¹ The design must provide sufficient mechanical strength to withstand the centrifugal force. In the case of turbo-generators running at

¹ See Standardization Rules, American Institute of Electrical Engineers, 1914.

high speed the diameter is limited by the consideration that the peripheral velocity shall not exceed 8000 ft. per minute, hence, to secure sufficient radiating surface the commutator must have a considerable axial length. To prevent springing of the segments they are held in place by steel rings shrunk over the segments, and thoroughly insulated therefrom, as shown in Fig. 57.

43. The Armature Core.—**EDDY CURRENTS.**—The armature core not only carries the magnetic flux from pole to pole, but revolves through it in exactly the same manner as the conductors of the armature winding. If the core were solid it might be thought

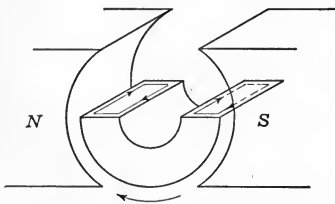

FIG. 48.—Eddy current paths in solid armature core.

of as made up of a very large number of metallic filaments running parallel to the armature conductors and all connected together; in such a case each filament would be the seat of a generated e.m.f., and currents would circulate in the mass of the core in the manner sketched in Fig. 48. The e.m.f.

will obviously be greatest near the surface where the peripheral velocity and the active component of the flux are likewise greatest. To minimize these *eddy* or *Foucault currents*, which, if unchecked, would result in excessive heating and loss of power, the core must be *laminated* in such a manner as to preserve the continuity of the flux path and to break up the current paths. The plane of the laminations must be at all points perpendicular to the direction of the generated e.m.f. at those points; or, by Fleming's rule, parallel to the direction of the flux and to the direction of motion. Accordingly, in machines of the usual radial pole type, Fig. 44, the armature core is built up of thin sheet steel punchings insulated from each other; sometimes the insulation consists of a coating of varnish on one side of each disk, but generally the oxide, or scale that forms on the sheets, is relied upon to provide the necessary insulation; in some designs a layer of paper is inserted at intervals of an inch or two. Laminating the core does not completely eliminate eddy currents, but the loss due to them decreases as the square of the thickness of the sheets; the sheet steel ordinarily used in armature cores is 0.014 in. thick. Armatures of the now

obsolete disk type, Fig. 49, with active conductors arranged radially, had cores built up of concentric hoops, or, more practically, of thin strap iron wound as a flat spiral.

Core punchings up to a diameter of about 16 in. are generally made in one piece, as in Fig. 50. The disks are first blanked out

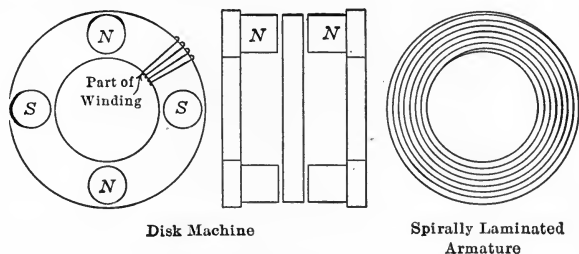

FIG. 49.—Lamination of disk armature.

and the slots are then punched by a special punch press which cuts one or more slots at a time. Core punchings of this sort are generally keyed directly to the shaft, and are sometimes provided with holes near the shaft to form longitudinal ventilating passages. Cores of large diameter are built up of segments which are attached to the spider by means of a dove-tail joint, as in Fig. 44; the joints between segments are staggered from layer to layer in order to preserve the continuity of the magnetic circuit. The core punchings are held together by end flanges which, in the case of small machines, are supported by lock nuts screwed directly to the shaft; in larger machines the end plates are held together by bolts passing through the laminations, but insulated therefrom, and the end plates are shaped to provide a support for the end connections of the armature winding (see Fig. 44).

Ventilating ducts through the core are formed by means of spacing pieces placed at intervals of from 2 to 4 in. along the axis of the core. The spacing pieces are generally made by

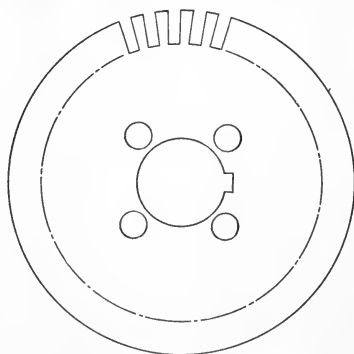

FIG. 50.—One-piece armature punching.

riveting brass strips, on edge, to a punching of heavy sheet steel, as illustrated in Fig. 51; or they may be made by pressing spherical depressions into a thick punching. The ventilating ducts vary in width from $\frac{1}{4}$ to $\frac{3}{8}$ in. The spacing pieces should be so designed as to support the teeth as well as the body of the core, in order to prevent vibration and humming.

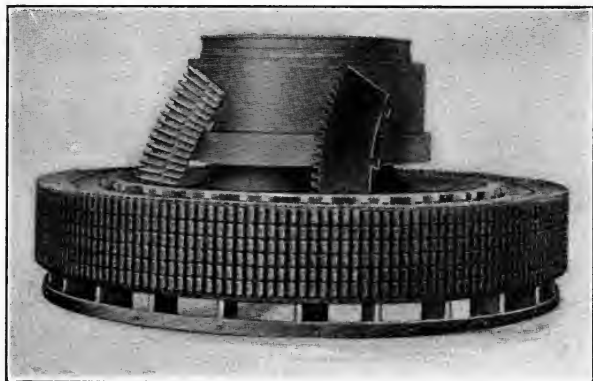

FIG. 51.—Armature core assembly, showing spacing pieces.

Fig. 52 illustrates typical forms of teeth and slots for direct-current machines. Smooth core armatures are used only in special machines. Open slots with parallel walls are generally used, except in the case of very small machines, for the reason that they permit the use of insulated, formed coils that can be readily slipped into place. Where semi-closed slots are used, the coils

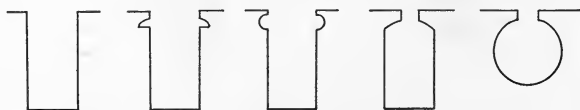

FIG. 52.—Typical shapes of teeth and slots.

may be formed on a winding jig, but the wires of each side of a coil must be slipped into the slot one at a time. The coils are held in place in open slots either by steel or bronze banding wires, or by wooden or fiber wedges driven into the recesses at the tips of the teeth.

The embedding of the armature winding in the slots serves a

double function; the air-gap, or distance from the pole face to the iron of the armature core, is less than it would be in a smooth-core construction having the same amount of armature copper, and so reduces the amount of field copper necessary to produce the flux; and the armature conductors are supported by the teeth when subjected to the tangential forces caused by the reaction of the armature current upon the field flux. When the armature conductors are thus embedded in the slots they are apparently shielded from the inductive effect of the field flux, since the latter in large measure passes around the slots by way of the teeth. At first sight, therefore, it seems surprising that the fundamental equation for the generated e.m.f. is the same for a slotted armature as for a smooth-core armature. It must be remembered, however, that a line of force which at a given instant crosses the air-gap from the pole face to a given tooth tip, must later, by reason of the motion of the armature, be transferred from this tooth-tip to the following tooth. The line of force holds on, as it were, to the first tooth in the manner of a stretched elastic thread, until the increasing tension causes it to snap back suddenly to the next tooth. The increased velocity of cutting of the lines of force by the conductors exactly compensates for the reduced value of the field intensity in the slot.

44. The Pole Cores and Pole Shoes.—The pole cores are generally made of cast steel. When cast steel is used, the poles usually have a circular cross-section because this results in minimum length and weight of the copper wire in the field winding. Laminated poles of course require a rectangular cross-section. Solid poles are commonly bolted to the yoke. Laminated poles may be secured in place either by a dovetail joint or may be cast into the yoke.

The flux density in the body of the pole core, running as high as 110,000 lines per sq. in., is considerably greater than can be economically produced in the air-gap. The average flux density in the air-gap should not exceed 62,000 lines per sq. in., hence the pole faces must have greater area than the pole cores. This increased area is secured by means of pole shoes bolted or dovetailed to the core in the case of solid poles, or by means of projecting tips or horns punched integrally with the sheets composing a laminated pole. The pole faces or shoes are almost always lami-

nated, even when solid poles are used, in order to reduce the loss and heating due to eddy currents set up in the pole faces by the armature teeth; for, as shown in Fig. 53, the flux passing between the pole face and armature core tends to tuft opposite the teeth, and as the teeth move across the pole-face these tufts are drawn tangentially in the direction of rotation until the increasing tension along the lines of force causes them to drop back to the next following tooth. The tufts of flux are therefore continuously swaying back and forth, and if the pole face is considered as built up of thin filaments, as at *P* in Fig. 53, each of the filaments

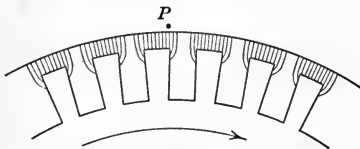

FIG. 53.—Tufting of flux at tips of teeth.

will be cut by these swaying tufts first in one direction, then in the other, thereby inducing an alternating e.m.f. directed parallel to the shaft. To minimize the flow of current the pole face must therefore be laminated

in planes parallel to those of the armature laminations, though the laminæ of the pole shoes do not have to be made as thin as those of the armature core. These pole-face eddy current losses will obviously be reduced by so proportioning the dimensions of teeth and slots as to prevent appreciable lack of uniformity in the distribution of the flux along the pole face. The determining factors in this proportioning are the ratio of slot opening to air-gap and the length of the air-gap itself.

45. The Yoke.—The yoke is that part of the field structure which carries the flux from pole to pole, and at the same time serves as a mechanical support for the pole cores. It is made of cast iron in small machines and of cast steel in larger sizes, or whenever saving in weight is important. The yoke is usually split on a horizontal diameter for convenience in assembling and repairing. In machines of moderate size the yoke is cast as an integral part of the bed plate; in larger sizes it is cast separately, but with lugs for bolting to the bed plate.

46. Brushes, Brush Holders and Rocker Ring.—The connection between the revolving armature and the external circuit is made through the *brushes*, which are usually made of graphitic carbon, except in the case of low-voltage machines when they may consist of copper or copper gauze. Carbon brushes are

made of varying degrees of hardness to suit the requirements of commutation, as discussed in a later chapter. The graphite in the brush serves to partially lubricate the commutator, which, when fitted with brushes of the proper composition, takes on a polished surface of dark brown color. The width of the brush in the tangential direction is generally from three to five times the width of a commutator segment, so that several armature coils are simultaneously short-circuited. The carbon brush must have sufficient resistance to limit the current in the short-circuited coils to a value below that which would result in sparking when the short-circuits are opened.

The brushes are commonly set at a trailing angle with respect to the direction of rotation, though in machines designed to run in both directions, such as railway motors, they are set radially.

When the tangential width of the brush has been decided upon, the total axial length of the brushes constituting a set is determined by the consideration that there must be a contact area of 1 sq. in. for every 30 to 50 amperes to be carried by the brush set, though this current density may be exceeded in the case of interpole machines. The individual brushes of a set must not be too large in cross-section, otherwise there would be difficulty in making and maintaining a good contact over its entire contact surface. The subdivision of the set offers the additional advantage of allowing the individual brushes to be trimmed one at a time without interfering with the operation of the machine when under load. Single brushes are used only in the case of machines of small current output.

The individual brushes are supported in metal *brush holders* which are in turn supported by studs attached to, but insulated from, the *rocker ring*, as illustrated in Fig. 54. The brush holders serve as guides for the brushes, and should allow the brush to slide freely in order that the brush may follow irregularities in the commutator surface. The construction of the brush holders must be such that there will be no vibration of the brushes, this being a common cause of sparking. The brushes are held against the commutator surface by adjustable springs attached to the holder, but in such a manner that the springs do not carry any current. The tension of the springs is adjusted until the brush presses against the commutator with a force of from 1.5 to 2 pounds

per sq. in. of contact area. Increasing the brush pressure above this limit does not materially lower the contact resistance, but increases the sliding friction and, therefore, results in increasing loss of power and heating of the commutator. The connection between the brush and the brush holder is made through a flexible lead of braided copper wire, called a *pig-tail*, which is attached to the outer end of the brush by means of a metal band clamped tightly around the carbon. The carbon is generally copper-plated at its outer end to insure good contact.

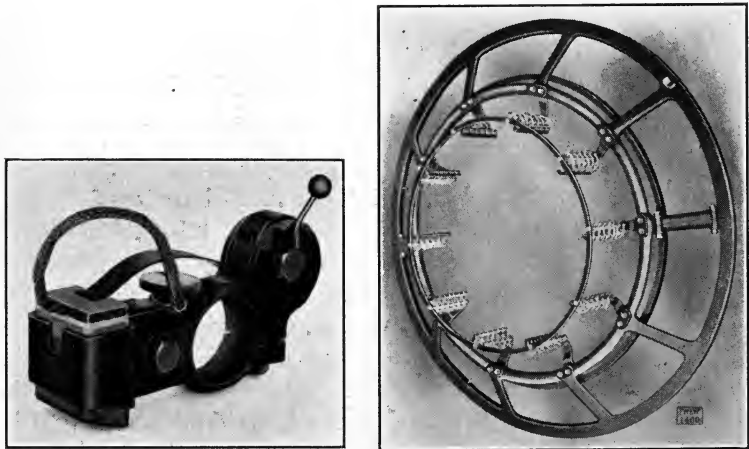

FIG. 54.—Brush holder and rocker ring.

47. Motor-generator. Dynamotor.—It is frequently necessary to convert direct current at one voltage into direct current at some other voltage, higher or lower than the first. For this purpose a *motor-generator* is used. As ordinarily constructed, a motor-generator set consists of two separate machines, a motor and a generator, direct connected to each other, and mounted on a common bed plate, as illustrated in Fig. 55. Motor-generators are also used to convert direct current into alternating current, or *vice versa*. This type of machine has the advantage that the voltage of the generator end may be controlled independently of that of the motor end of the outfit. The over-all efficiency of the set is equal to the product of the efficiencies of

the motor and generator. The power rating of the motor must in general be sufficiently greater than that of the generator to allow for the losses that occur in the double transformation of the energy.

Instead of using two separate machines, as in a motor-generator set, to convert the current from one voltage to another, it is possible to combine the two into a single unit, called a *dynamotor*, having a single field structure and a single armature core. By providing the armature of such a machine with two separate

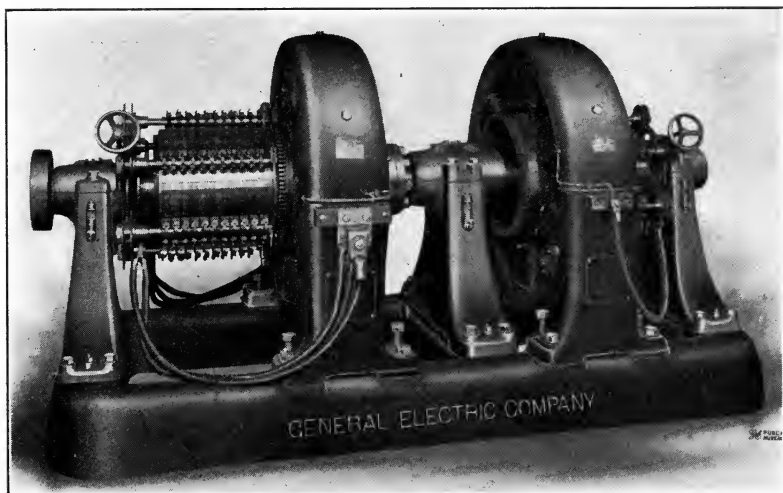

FIG. 55.—Motor-generator set.

windings, each with its own commutator and brushes, current may be introduced into one of the windings, thereby causing motor action, while the other winding will then generate an e.m.f. This type of machine is built in small sizes only. It is open to the objection that the voltage at the generator terminals cannot be independently regulated, but is fixed by the voltage impressed upon the motor terminals. The truth of this statement can be seen from the following reasoning: If the e.m.f. impressed upon the motor terminals is E_m , the rotation of the armature through the field flux Φ will generate in the motor armature winding an approximately equal and opposite voltage (Art. 31); if there were

no losses in the motor, this counter e.m.f. would be equal to E_m , hence by equation (17)

$$E_m = \frac{p\Phi Z_m n}{a_m \times 60 \times 10^8}$$

Since the generator winding rotates through the same field as the motor winding and at the same speed, the generator e.m.f. is

$$E_g = \frac{p}{a_g} \frac{\Phi Z_g n}{60 \times 10^8}$$

or

$$\frac{E_g}{E_m} = \frac{a_m}{a_g} \cdot \frac{Z_g}{Z_m} = \text{constant} \quad (18)$$

The disadvantage of the fixed ratio of voltage transformation is offset by the reduced cost of construction made possible by the single armature and field structure. The dynamotor has in addition a higher efficiency than a motor-generator, and is practically free from trouble due to armature reaction.

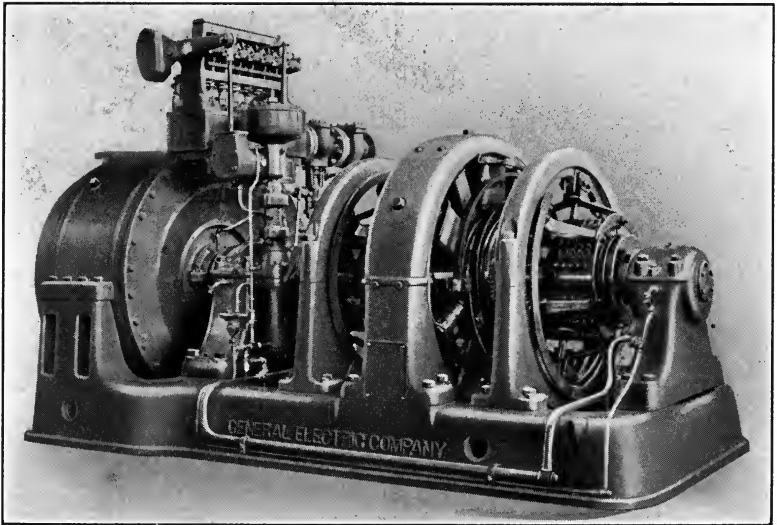

FIG. 56.—Turbo-generator set.

48. Turbo-generators.—Generators for direct connection to steam turbines must be designed for high speed of rotation since the steam turbine develops its maximum efficiency under this condition. The high rotative speed calls for special design to

withstand the centrifugal forces and to provide sparkless commutation. The end-connections of the armature winding are held in place by metal end-shells in place of the usual banding wires, and the commutator segments are prevented from springing by a steel ring or rings shrunk over them. To provide for satisfactory commutation these machines are provided with *interpoles* (Art. 49) whose function it is to generate in the coils undergoing commutation an e.m.f. of the proper magnitude and direction to reverse the current in the short time required for the segments to pass across the brush. Fig. 56 represents a 300-kw.,

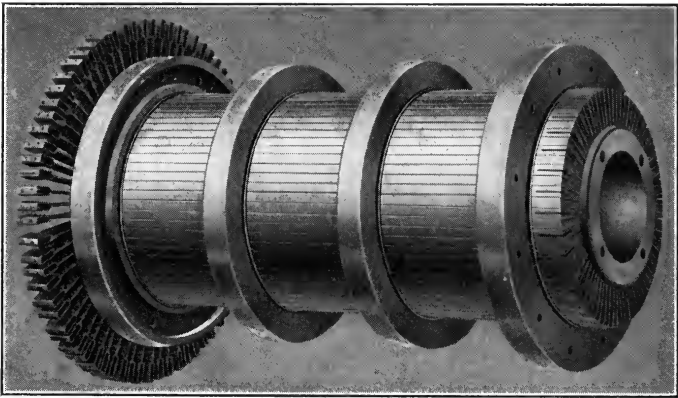

FIG. 57.—Commutator of high-speed generator.

125-volt, 1500-r.p.m. set manufactured by the General Electric Company. This machine has a double commutator, and the interpoles are clearly seen between the main poles. Fig. 57 shows the steel rings around the commutator of a 125-volt, 125-kw. machine.

Turbo-generators require a high grade of brushes to insure satisfactory commutation. The brushes wear down quite rapidly and must be adjusted with great care.

49. Interpole Machines.—A full discussion of the function of interpoles must be deferred to a later chapter. The interpoles, also called auxiliary poles or commutating poles, are small poles placed midway between the main poles; they are wound with coils through which the armature current, or a fractional part thereof, is made to flow. Interpoles are used in machines where sparkless

commutation would otherwise be difficult or impossible of attainment, as in turbo-generators, variable speed motors, etc.

50. The Unipolar or Homopolar Machine.—In the type of armature described in the preceding sections, the individual coils have generated in them alternating e.m.fs. which are then rectified by the commutator; the latter plays much the same part as the valves of a double-acting reciprocating pump. In the centrifugal pump, on the other hand, the developed pressure acts continuously in one direction, thereby obviating the necessity for the rectifying valves, and the electrical analogue of the centrifugal pump is found in the so-called unipolar, or homopolar, or acyclic generator, shown in section in Fig. 58. In principle, this

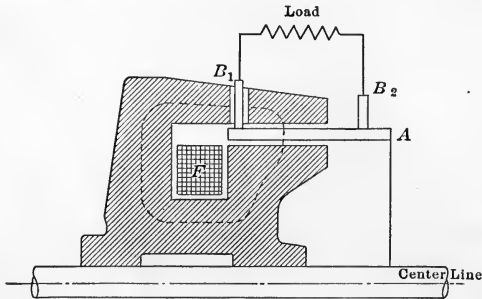

FIG. 58.—Homopolar or acyclic generator.

machine consists of a conductor so disposed in a magnetic field that the cutting of the lines of force is continuously in one direction; it is a true continuous-current machine. The armature consists of a metal cylinder *A* of low resistance, insulated from the shaft, and upon whose edges the two sets of brushes *B*₁ and *B*₂, make sliding contact. The armature rotates in a magnetic field produced by the exciting winding *F*, the path of the flux being indicated by the dashed line. The lines of force pass radially across the air-gap all around its periphery.

If the intensity of the magnetic field in the air-gap is *B* lines per sq. cm., the axial length of the active part of the cylinder *l* cm., and its peripheral velocity *v* cm. per second, the generated e.m.f. will be $e = Blv \times 10^{-8}$ volts. The maximum e.m.f. obtainable with this type of machine is determined mainly by the consideration that *B* and *v* may not exceed definite limits; the length *l* is likewise limited by such mechanical features as rigidity, freedom

from vibration, etc. At the high rate of rotation required for any reasonable value of e.m.f., difficulty is experienced in securing good brush contact. Thus if $B = 15,500$ (100,000 lines per sq. in.), $l = 60$ cm. (about 2 ft.), and $v = 5000$ cm. per second (about 10,000 ft. per minute), $e = 46.5$ volts. Because of the fact that the armature consists of a single conductor of large cross-section, the machine is adapted for heavy currents at relatively low voltage. Unfortunately, however, the magnetizing action of the large armature current when the machine is under load so weakens the field produced by the exciting coil F that the voltage drops considerably.

The analogy between the homopolar machine and the centrifugal pump suggests the idea that, just as high pressures may be obtained with the latter by using several stages, higher voltages may be obtained with the former machine by using several inductors in series. Such a machine has been built by the General Electric Co.¹ for 300 kw. at 500 volts and 3000 r.p.m.; and the Westinghouse Electric and Manufacturing Company² has built one for 2000 kw. and 260 volts, running at 1200 r.p.m.

51. Field Excitation of Dynamos.—In every dynamo-electric machine the generation of the armature e.m.f. depends upon the motion of the armature inductors through a magnetic field. In the earliest types of machines this magnetic field was produced by permanent magnets; such machines are called magneto-electric machines or, briefly, magnetos. Their use is now confined to small machines intended for ringing call-bells in small telephone systems, for gas-engine igniters and for testing purposes. The field excitation of all other generators and motors is accomplished by means of electromagnets. The following types of field excitation may be recognized:

Separate excitation

Self excitation	{	Series excitation
		Shunt excitation
		Compound excitation

52. Separate Excitation.—In this type of field excitation the field winding is traversed by a current supplied from a source

¹ J. E. Noeggerath, Trans. A.I.E.E., Jan., 1905.

² B. G. Lamme, Trans. A.I.E.E., June, 1912.

external to the machine itself, such as a storage battery or another generator. The most prominent examples of this type are alternating-current generators and certain kinds of low-voltage direct-current generators used for electroplating. Fig. 59 represents diagrammatically the connections of such a machine.

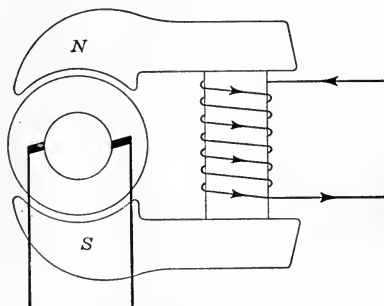

FIG. 59.—Diagram of separately excited machine.

machine to develop its own magnetic field. Self-excited machines may be divided into three classes, depending upon the connections of the field winding to the other parts of the circuit; these classes are *series* excitation, *shunt* excitation and *compound* excitation.

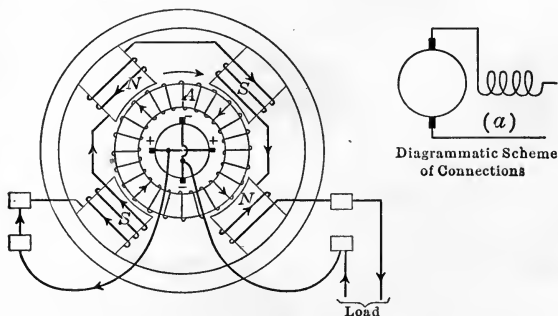

FIG. 60.—Connections of series generator.

54. Series Excitation.—In Fig. 60, *A* represents the armature and *N, S, N, S*, the field structure of a four-pole machine. All of the current taken by the external circuit passes through the field winding and the armature, since all these parts of the circuit are in series. The arrows indicate the direction of the current in the

53. Self-excitation.—The use of electromagnets, separately excited for the production of the magnetic field, was introduced by Wilde in 1862. A great step in advance was made in 1867 when Werner Siemens discovered the principle of self-excitation, whereby the armature current, in whole or in part, was made to traverse the field winding, thus causing the

case of generator action and for clockwise direction of rotation of the armature.

If the field structure of such a machine is originally unmagnetized, rotation of the armature cannot generate e.m.f., hence there can be no current in the circuit. In order that the machine may self-excite, it is necessary that there be some residual magnetism in the field poles due to previous operation, or, in the case of a new machine, produced by sending current through the field winding from some suitable external source. Assuming, then, that residual magnetism is present, a small e.m.f. will be generated when the armature is rotated, and, upon closing the external circuit through the load, a small current will flow. This current will further excite the field structure, thereby developing more e.m.f. and a still greater current, and so on. This gradual increase of both e.m.f. and current will continue until a condition of equilibrium is reached, this being determined by the degree of saturation of the field magnet and by the resistance of the circuit, in a manner that will be discussed fully in the chapter on operating characteristics.

It is important to note, however, that if the field terminals are reversed the machine will refuse to "build up" as described above. For in this case the generated e.m.f. will send a current through the circuit in such a direction as to neutralize the remanent magnetism. Further, if the resistance of the circuit exceeds a critical value, the resultant flow of current may be insufficient to produce the requisite magnetizing force.

From the above description of the process of building up of a series generator, it is obvious that such a machine when running on open circuit (the receiving circuit disconnected) will develop only the small e.m.f. caused by residual magnetism; and that with increasing current, as the external resistance is lowered, the generated e.m.f. likewise increases, though not in general proportionally.

The field winding of series machines consists of relatively few turns of coarse wire. Since the entire current, i , delivered by the machine to the receiver circuit must flow through the resistance, r_f , of the field winding, there occurs a loss of power equal to $i^2 r_f$ watts in this part of the circuit. Obviously, this loss must be kept as small as possible in order that the efficiency of the dynamo

may not be seriously impaired, and since the magnitude of the current i is fixed by considerations of the load to be supplied, it follows that r_f must be kept as small as possible; hence the conclusion that the wire of the field winding must have large cross-section and moderate length.

55. Shunt Excitation.—Fig. 61 shows the same armature and field frame as Fig. 60, but provided with a shunt field winding. Fig. 61a represents the connections in a simple diagrammatic manner. It is evident that the exciting current now depends

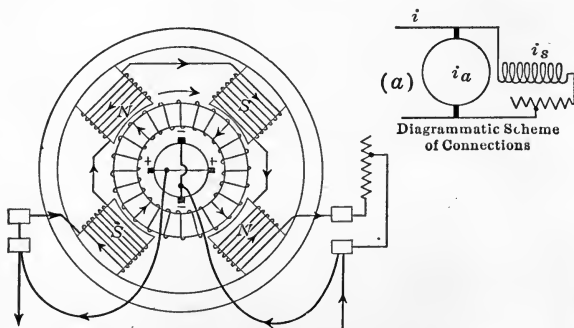

FIG. 61.—Connections of a shunt generator.

upon the e.m.f. at the brushes and upon the ohmic resistance of the field winding; it is not dependent upon the resistance of the receiver circuit in the same sense as in the previous case, but only to the extent that variations of the external resistance affect the brush voltage. If the external circuit is entirely disconnected, the remaining connection between armature, shunt winding and field regulating rheostat is precisely the same as that of a series generator. On open circuit, therefore, a shunt generator will build up just as a series generator does under load conditions; if it fails to do so, it is usually because of one or the other of the reasons discussed in the preceding section.

It is clear, therefore, that a shunt generator, unlike one of the series type, develops full terminal voltage at open circuit, that is, when no current is being supplied to the receiver circuit. Suppose, now, that the external circuit is closed through a considerable resistance so that a small load current, i , is drawn from the generator. The armature current, which was originally equal to

i_s alone, now becomes $(i + i_s)$, and the effect of this increased current through the ohmic resistance of the armature is to cause a drop of terminal voltage; this in turn results in a decrease of the exciting current, i_s , and consequently also of the magnetic flux and the generated e.m.f. As the load current becomes greater and greater the terminal voltage therefore becomes less and less. It is clear that the drop of voltage will be minimized if the resistance of the armature is kept low. The drop of voltage under load conditions is also affected by armature reaction and by the degree of saturation of the magnetic circuit. A complete discussion is given in Chap. VI.

The field winding of a shunt machine consists of many turns of fine wire, for the following reason: If the terminal voltage of the machine is E_t volts, the shunt field current, i_s , will be $\frac{E_t}{r_s}$, and the power loss in the winding will be $i_s^2 r_s = \frac{E_t^2}{r_s}$; since E_t is fixed by other considerations, it follows that r_s must be as large as is feasible (in order to keep down i_s and the loss of power) hence the use of wire of small cross-section and great length.

The relation between the armature current i_a , the line current i and the shunt field current i_s , in the case of *generator* action, is given by the equation

$$i_a = i + i_s \quad (19)$$

In the case of *motor* action the relation is obviously

$$i = i_a + i_s \quad (20)$$

It should be remembered that the armature and field currents of a shunt motor do not divide in the inverse ratio of their respective resistances, for the reason that the armature, when running, is the seat of a counter-generated e.m.f. The field current is given by $i_s = \frac{E_t}{r_s}$, but the armature current is $i_a = \frac{E_t - E_a}{r_a}$, where E_a is the counter e.m.f.

56. Compound Excitation.—In some of the most important applications of direct-current machinery, such as incandescent lighting, street-railway operation, and the like, it is necessary to maintain a constant difference of potential between the supply mains no matter what the load may be. Since the center of the

load is usually at a distance from the generator, it follows that the potential difference between the generator terminals should rise as the external current increases, in order to compensate for the drop of potential in the supply mains. Field windings adapted to give this characteristic are called compound windings, illustrated in Fig. 62 and diagrammatically in Figs. 63a and 63b. They are combinations of shunt and series field windings.

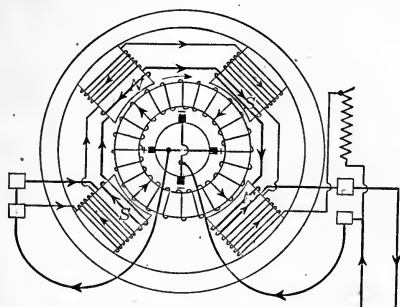

FIG. 62.—Connections of a compound generator.

Connections made in accordance with Fig. 63a result in a *short-shunt* winding, those of Fig. 63b in a *long-shunt* winding. The shunt winding of itself would produce a “drooping” characteristic, that is, one in which the terminal e.m.f. falls with increasing current, as explained in the preceding section; but the series winding contributes field excitation which increases with increasing

current, hence the resultant effect will depend upon the relative magnitudes and directions of the magnetizing actions of the two field windings. By properly proportioning them, the voltage-current curve may rise, in which case the machine is said to be *over-compounded*; or the voltage may remain very nearly con-

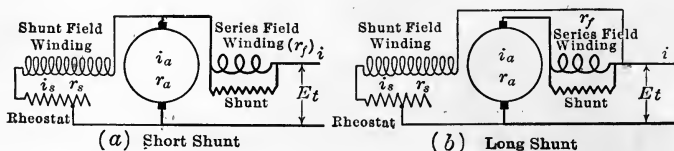

FIG. 63.—Diagrammatic scheme of connections of compound machines.

stant for all permissible values of current, as in a *flat-compounded* machine; or it may fall at a greater or lesser rate than with the shunt winding alone, giving rise to the classification of *under-compounded* machines.

In the short-shunt compound-wound generator the relation

between armature current i_a , line current i , and shunt-field current i_s is given by

$$i_a = i + i_s$$

The terminal e.m.f., E_t , and the generated e.m.f., E_a , are related by the equation

$$E_a = E_t + ir_f + i_a r_a \quad (21)$$

and the shunt-field current is given by

$$i_s = \frac{E_a - i_a r_a}{r_s} = \frac{E_t + ir_f}{r_s} \quad (22)$$

In the long-shunt compound-wound generator these relations become

$$i_a = i + i_s$$

$$E_a = E_t + i_a r_f + i_a r_a \quad (23)$$

$$i_s = \frac{E_t}{r_s} \quad (24)$$

57. Construction of Field Windings.—In designing the field windings of shunt, series and compound machines, the selection of the correct number of turns and the cross-section of the conductors follows from a knowledge of the number of ampere-turns per pole required to produce the flux Φ , and from the dimensions of the pole core. The calculation of these latter quantities depends upon principles that are discussed in detail in Chap. IV. Assuming that the number of ampere-turns per pole and the dimensions of the pole core are known, the determination of the size of wire to be used is as follows:

Let

i_s = current in shunt winding

E_t = terminal voltage at no load

e_r = voltage consumed in regulating rheostat, varying from 10 per cent. to 20 per cent. of E_t .

The object of the field rheostat is to permit an increase of i_s by cutting out a part or all of the regulating resistance, thereby raising the generated e.m.f.

The resistance of the winding per pole is then

$$r_s' = \frac{E_t - e_r}{i_s p} = \rho \frac{1/2 n_s l_t}{A} \quad (25)$$

where

ρ = specific resistance of copper at the working temperature of the winding (75° C.)

n_s = number of shunt turns per pair of poles

l_t = mean length of a turn

A = area of cross-section of conductor.

If lengths are expressed in feet and cross-sections in circular mils, $\rho = 12.6$ at 75° C. Hence

$$A = \frac{6.3(n_s i_s) l_t \rho}{E_t - e_r} \text{ circular mils.} \quad (26)$$

The mean length of a turn, l_t , is found by assuming a depth of winding of from 1 to 3 in. If the cross-section of the pole core is rectangular, l_t will be approximately equal to the perim-

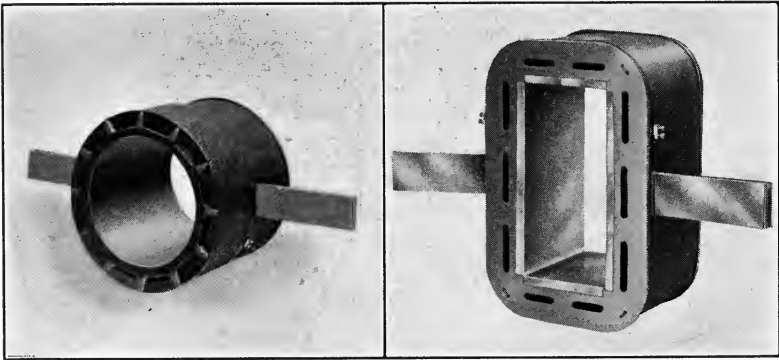

(a)

(b)

FIG. 64.—Ventilated field coils.

eter of the core plus four times the winding depth; if the pole core is circular, of diameter d_c , $l_t = \pi(d_c + \text{winding depth})$. The winding depth must not exceed a definite limit, otherwise the heat generated in the interior of the core cannot be readily conducted to the surface. As a check on the calculations, it must be ascertained that the power lost in the coil ($i_s^2 r_s'$) does not exceed approximately two-thirds of a watt per sq. in. of exposed radiating surface.

Shunt coils are usually made of cotton-covered wires, of either round or rectangular section. Sometimes they are wound on

metal frames arranged to slip onto the pole cores; sometimes they are wound on removable winding forms, the coils being held in shape by suitable insulating materials and dipped in, or painted with, moisture-proof varnish. When metal frames are used, they are frequently made with a double wall to allow the circulation of air between pole core and winding, as shown in Fig. 64. The coils of series-wound railway motors are usually impregnated with insulating compound, then taped and varnished. The series coils

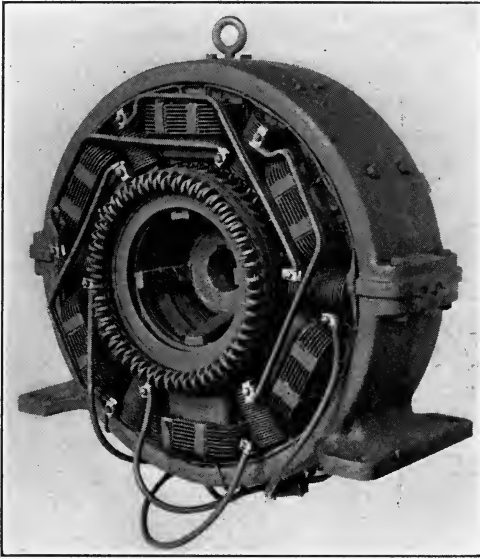

FIG. 65.—Interpole machine, edge-wound copper strap coils.

of compound and interpole machines are often made of copper strap, wound on edge, the turns being separated by distance pieces of insulating material, as shown in Fig. 65.

In order that connections may be easily made between the coils of adjoining poles, the terminals of the coils are brought out on opposite sides, so that the number of turns per coil is an integer, plus one-half.

58. Field Rheostats.—To permit regulation of the voltage of shunt and compound generators, the current in the shunt-field winding must be under control. To this end a variable resist-

ance, or *field rheostat*, is inserted in series with the shunt winding, as shown diagrammatically in Figs. 61 and 62. This resistance

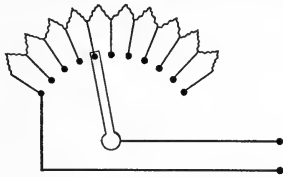

FIG. 66.—Diagram of connections of field rheostat.

is arranged in the manner shown in Fig. 66, taps being brought out from the high resistance wire or ribbon composing the resistor to a series of insulated studs over which moves an adjustable contact arm. The terminals

are always brought out in such a way that clockwise rotation of the regulating handle increases the resistance in circuit and so throttles the current in the manner of an ordinary valve.

Field rheostats are generally arranged to be mounted on the back of the switchboard, with the regulating handle on the front of the board. Fig. 67 represents a field rheostat made by the General Electric Company. Field rheostats for machines of large capacity are made of cast-iron grids, as shown in Fig. 68.

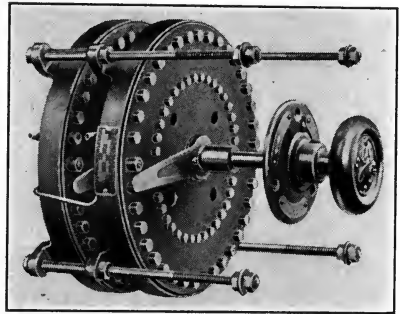

FIG. 67.—Field rheostat, back connection.

In shunt and compound generators of large capacity the energy

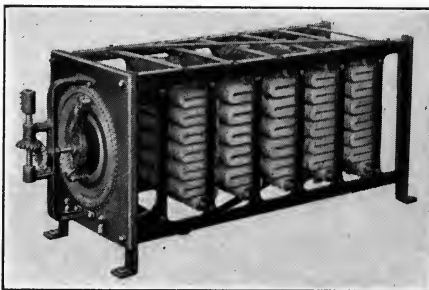

FIG. 68.—Large field rheostat.

stored in the magnetic field is very considerable, amounting to $\frac{1}{2}L_s i_s^2$, where L_s is the inductance of the shunt winding. The inductance may have a value of several hundred henries. For instance, if $L_s = 600$ and $i_s = 4$, the energy stored in the field is 4800 joules. If the field

circuit is abruptly broken, this energy will have to be dissipated in the arc formed on breaking the circuit; if, for example, the

current were made to disappear in one-half second, the average rate of energy dissipation would be $4800 \div \frac{1}{2} = 9600$ watts, and the average voltage induced by the collapse of the magnetic field would be $L_s \frac{di_s}{dt} = 600 \times 8 = 4800$ volts. In this case the arc would be very destructive, and the high induced voltage would be likely to puncture the insulation of the winding. To obviate this danger the field current must be gradually reduced before breaking the circuit. In large machines the reduction of field current is accomplished by allowing the field windings to discharge through a *field discharge* resistance, connected in the manner shown in Fig. 69.

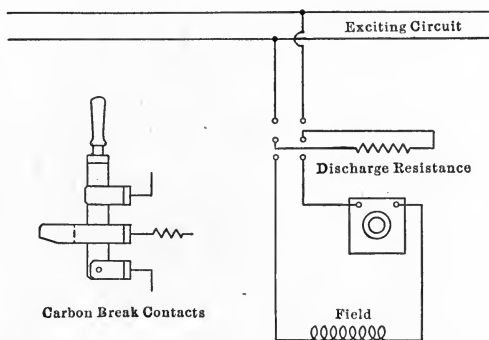

FIG. 69.—Diagram of connections of field discharge resistance.

59. Polarity of Generators.—In order that a self-exciting generator of any of the types already described may be operative, it is necessary that there be some remanent magnetism in the field system; further, that the initial flow of current through the exciting winding have such a direction that it will strengthen the remanent field. In other words, the polarity of the machine is determined by that of the remanent magnetism.

For example, consider the conditions existing in the shunt-wound generators illustrated in Figs. 70*a* and 70*b*, respectively. The machines are identical except that the remanent magnetism of the second is reversed with respect to that of the first. In both cases the machine will build if the direction of rotation is clockwise, but with the polarity of the terminals of the one opposite to that of the other. With the connections as shown,

counter-clockwise rotation would set up a field current which would wipe out the remanent magnetism; but with counter-clockwise rotation the machines would again become self-exciting if the terminals of the field winding are interchanged.

In Figs. 70a and 70b, the armature winding is *right-handed*, that is, it is wound around the core in the manner of a right-handed

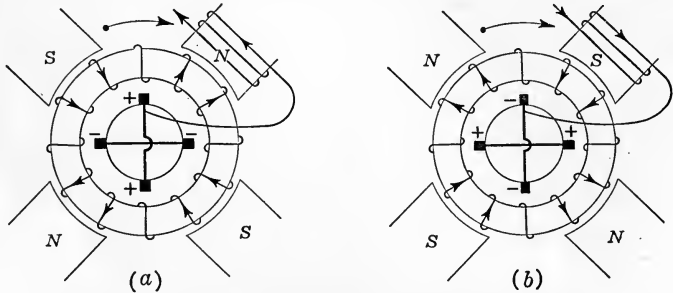

FIG. 70.—Effect of reversal of residual magnetism.

screw thread. If *left-handed* armature windings had been used (Fig. 71), other conditions remaining the same, annulment of the remanent magnetism would again be the result. Finally, it is clear that the direction of the winding around the poles plays a similar role.

There are therefore four elements which effect the polarity of such a machine: The *sense* of the windings of armature and pole

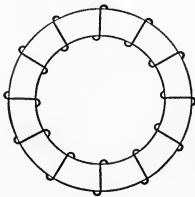

FIG. 71.—Left-handed ring wound armature.

pieces, respectively; the direction of rotation; and the order of connections of the field winding terminals to the armature terminals.

With a given remanent magnetism, the machine will operate only when there is a definite relation between them. Assuming that the conditions for operation are satisfied, a change in any one of these four elements will cause the machine to lose its residual magnetism,

but a change in any two of them will not affect the operation. Thus, a right-handed armature rotating clockwise in a given field flux will yield the same brush polarity as a left-handed armature rotating counter-clockwise in the same field.

In general, a change in an *odd* number of the four elements

will disturb conditions if they were previously correct, while a change in an *even* number of them will not affect the operation.

60. Direction of Rotation of Motors.—The same types of field windings and connections as are used for generators find equal application in the case of motors. Series motors, when supplied with constant terminal e.m.f., fall off rapidly in speed as the load increases, or, to put it in another way, “race” as the load is removed; this characteristic of variable speed at constant terminal e.m.f. is a sort of “mirror” image of the series generator characteristic, namely, variable voltage at constant speed. The speed characteristic of the series motor adapts this machine to street railway and hoisting service. Again, the shunt motor, when supplied with constant terminal e.m.f., operates at prac-

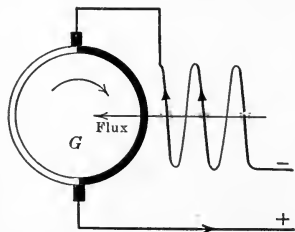

FIG. 72.—Diagrammatic sketch of series generator.

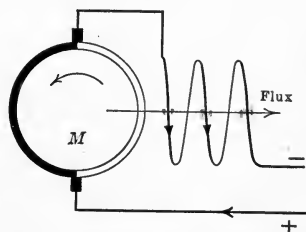

FIG. 73.—Diagrammatic sketch of series motor.

tically constant speed at all loads, just as the shunt generator delivers a nearly constant terminal voltage (within limits of machine capacity) when driven at constant speed. An over-compounded generator used as a motor will rise in speed with increasing load, if supplied from constant potential mains (see Chap. VII).

Let Fig. 72 represent diagrammatically a series machine used as a generator, the shaded half of the armature circle representing a belt of current flowing into the plane of the paper and the unshaded half representing current of opposite direction. If this machine is now connected to mains of the polarity indicated in Fig. 73, and is operated as a motor, its direction of rotation will be reversed as may be seen by applying (the left-handed) Fleming's rule. This means that a series generator supplying a network fed by other generators may, if overloaded, tend to reverse its direction of rotation and so buckle the connecting rod of the

driving engine. The fundamental reason for the reversal of direction of rotation is that both armature current and field current reverse simultaneously. If only one of these were reversed, the direction of rotation would remain unaltered. If, however, the motor, Fig. 73, is supplied with current from mains of reversed polarity, the direction of rotation will be the same as before. To reverse the direction of rotation of a motor it is necessary to reverse the connections of either the armature or the field winding, not those of both.

In the case of two identical shunt machines, one used as a generator and the other as a motor, as in Fig. 74, the direction of rota-

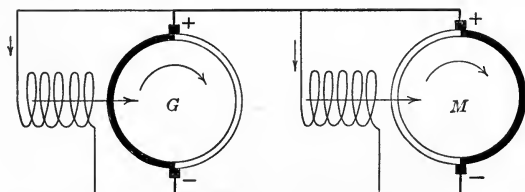

FIG. 74.—Showing direction of rotation of shunt generator and motor.

tion is the same in both. A shunt generator supplying a network will, therefore, not reverse its direction of rotation if its prime mover is disconnected or shut down, but will continue to run as a motor. Further, if the polarity of the line supplying a shunt motor is reversed, the direction of rotation will not be affected since both field and armature current reverse simultaneously. The direction of rotation of a shunt motor can be reversed by reversing the connections of either the armature winding or the field winding separately.

PROBLEMS

1. A concentrated coil of 100 turns is wound on a wooden frame measuring 50 cm. square. The coil is rotated at a uniform speed of 1000 r.p.m. about an axis passing through a diagonal of the square. If the coil is in a uniform magnetic field of intensity 200 gauss, whose direction is at right angles to the axis of rotation, what are the maximum and average values of the generated e.m.f.? What are the positions of the coil with respect to the direction of the field when the instantaneous e.m.f. has (a) its maximum value, (b) a value equal to the average e.m.f.?

2. If the square coil of Problem 1 is replaced by a circular coil of the same number of turns and a diameter such that it encloses the same area, what

will be the average e.m.f.? Compare the voltage per unit length of wire in Problems 1 and 2.

3. The 8-pole alternator of Fig. 28 has a field flux of 4×10^6 lines per pole, distributed sinusoidally around the periphery of the stationary armature. Each of the 8 slots contains 20 conductors, all conductors being connected in series. If the speed of rotation is 900 r.p.m., what are the average and maximum values of the generated e.m.f.?

4. The alternator of Fig. 28 is provided with pole shoes that cover two-thirds of the armature surface, and they are so shaped that the flux of 4×10^6 lines per pole crosses the air-gap along uniformly distributed radial lines. If the number of armature conductors and the speed are the same as in Problem 3, what are the average and maximum values of the generated e.m.f.? Construct a curve showing the variation of the e.m.f. from instant to instant.

5. A ring-wound armature like Fig. 41 has 400 conductors distributed uniformly on its periphery, and rotates in a 4-pole field structure that produces a flux of 1.5×10^6 lines per pole. At what speed must the armature rotate to develop an e.m.f. of 120 volts?

6. If the total amount of wire on the armature of Problem 5 consists of 500 ft. of No. 16 B. and S. wire, which has a resistance of 4.085 ohms per thousand feet at 75° F., what is the resistance of the armature measured between brushes?

7. The commutator of a machine which runs at 650 r.p.m. has a diameter of 18 in. There are four sets of brushes, each set consisting of three carbon brushes; each individual brush has a width of 1.5 in. and a contact arc of 0.25 in. The contact pressure is 1.5 lb. per sq. in. of brush contact area. If the coefficient of friction of carbon on copper is 0.3, what is the brush friction loss, expressed in watts?

8. A small series-wound generator has a normal rating of 110 volts and 10 amp. and its field winding has a resistance of 1.4 ohms. If the machine is to be used as a separately excited generator, the field current being supplied from 115-volt mains, how much resistance must be put in series with the field winding to produce normal field excitation?

9. A 220-volt shunt motor takes a field current of 1.4 amp. and, when running without load, an armature current of 1.5 amp. It is found by experiment that the full-load armature current of 25 amp. can be made to flow through the armature, under standstill conditions, by impressing 11 volts upon the armature terminals. What are the resistances of the field and armature windings, and what is the counter-generated e.m.f. when the machine is running under no-load conditions?

10. The field structure of the motor of the preceding problem has 4 poles and the winding is made of No. 18 wire which has a resistance of 7.76 ohms per thousand feet at the working temperature. Each field coil is wound on a cylindrical bobbin and has a mean diameter of 7 in. Find the number of turns per coil.

CHAPTER III

ARMATURE WINDINGS

61. Types of Armatures.—Armatures, considered as a whole, may be divided into three classes according to the shape of the core and the disposition of the winding upon it. These three classes are:

1. RING ARMATURES.
2. DRUM ARMATURES.
3. DISK ARMATURES.

The *ring armature* is one in which a ring-shaped core is wound with a number of coils, or elements, each of which winds in and out around the core in helical fashion, as in Figs. 38, 39, etc. In these windings the coils are usually connected successively to each other so as to form a continuous circuit, but this feature is not essential to the definition. The characteristic feature of ring windings is that there are conducting wires inside the ring which do not cut lines of force, and which do not, therefore, contribute to the e.m.f.

The *drum armature* was developed to reduce the amount of dead wire in a ring winding. Each active wire, wound on the outer surface in a direction parallel to the shaft, is connected to another active wire by means of connecting wires which do not thread through the core. The only reason for having any opening in the core at all is to permit ventilation and cooling. In bipolar machines the end connections run across the flat ends of the core and join conductors which are nearly diametrically opposite. In multipolar machines they join conductors separated by an interval approximately equal to the pole pitch, so that the e.m.fs. in the conductors thus connected may be additive.

The drum armature may be thought of as evolved from the ring type by moving the inner connections of the winding elements to the outer surface, at the same time stretching the coil circumferentially until the spread of the coil is approximately a pole pitch.

The *disk armature* differs from the other two types in that the active conductors, instead of lying on the outer cylindrical surface of the core, are disposed radially on the flat sides of a disk. The disk revolves between a number of pairs of poles of opposite signs, so that the wires on both faces of the disk are active (see Fig. 49). Disk armatures are seldom used in modern practice.

Of the three types of armatures described, the drum armature is used practically to the exclusion of the others, because it obviates the hand winding required in ring armatures; also, since the coils are wholly outside the core, they may be wound on formers, or winding jigs, and can be thoroughly insulated before being slipped into place.

62. Types of Windings.—All armature windings, for both direct- and alternating-current machines, belong to one or the other of the two types, *open-coil* and *closed-coil* windings. An open-coil winding is one in which, starting with any conductor and tracing progressively through the winding, a "dead-end" is finally reached; whereas, in a closed-coil winding, the starting point will finally be reached after having passed through all, or some sub-multiple, of the conductors. The use of open-coil windings is at present confined to alternating-current machines and need not, therefore, be considered here. Open-coil windings were at one time used to a large extent in direct-current series arc-lighting generators, such as the Brush and Thomson-Houston machines.¹

CLOSED-COIL WINDINGS

63. Ring and Drum Windings.

—In designing the armature of a generator or motor, the number of armature conductors is determined by the fundamental equation for the e.m.f. (equation 17, Chap. II). The problem is then so to connect the various conductors that their individual e.m.fs. will add together to produce the desired total e.m.f., and in such a way that the winding as a whole will be at all times symmetrical with respect to the brushes.

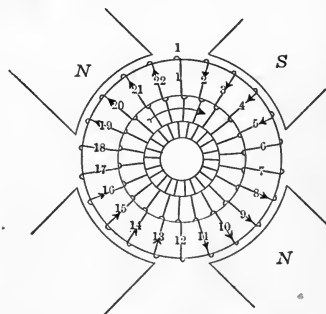

FIG. 75.—Ring wound armature.

¹See *Dynamo Electric Machinery*, S. P. Thompson.

In Figs. 75, 76, and 77 there are shown three distinct types of closed-coil windings for a 4-pole machine having twenty-two active conductors. Fig. 75 is a *ring* armature, while Figs. 76 and 77 are *drum* armatures. The arrangement of the winding in the case of the last two is made clearer by resorting to the use of the

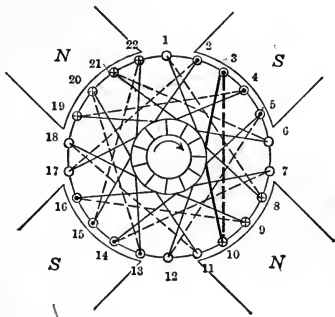

FIG. 76.—Drum armature, lap winding.

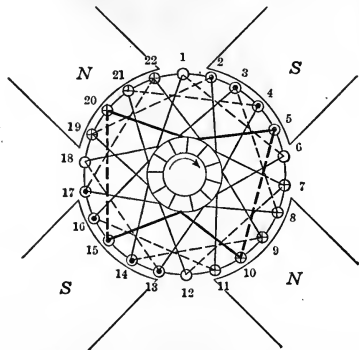

FIG. 77.—Drum armature, wave winding.

developed diagrams of Figs. 78 and 79, which are derived from Figs. 76 and 77, respectively, by rolling out the cylindrical surface of the armature core into a plane.

64. Winding Element.—It will be seen that in each case the winding consists of a number of identical *elements* which are

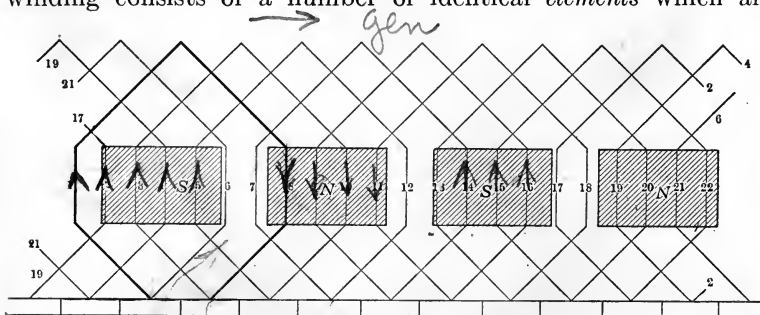

FIG. 78.—Developed lap winding.

shown in heavy lines in Figs. 76 to 79, inclusive. An element may be defined as that portion of a winding, which, beginning at a commutator segment, ends at the next commutator segment encountered in tracing through the winding. It will be evident



at once that an element may consist of more than one turn, *i.e.*, of more than two active conductors; for instance, Fig. 80 represents elements of windings similar to those of Figs. 75, 76 and 77, but with two turns each, instead of one.

Small machines for relatively high voltage, railway motors for instance, frequently have as many as five turns per element; but

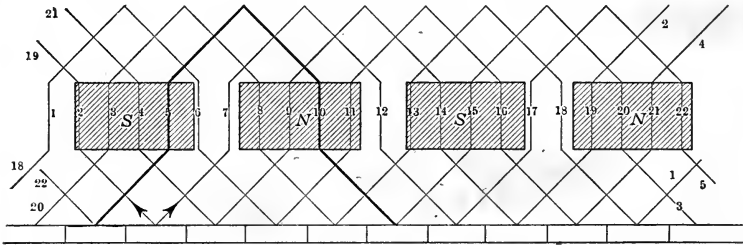

FIG. 79.—Developed wave winding.

in machines of large capacity there is, as a rule, only one turn per element for the purpose of improving commutation. Every time an element passes through the neutral zone of the magnetic field the current which it has been carrying must be reversed in direction; hence its self-inductance must be kept as small as possible in order that the reversal of the current may not be im-

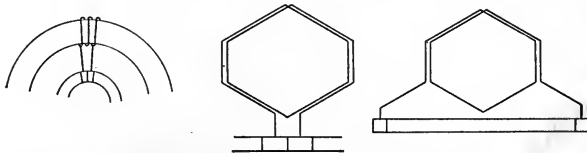

FIG. 80.—Winding elements having more than one turn.

peded, and as the coefficient of self-induction increases as the square of the number of turns, the number of turns should be a minimum, or unity, for best results.

65. Ring, Lap and Wave Windings.—The three windings of Figs. 75, 76; and 77 belong, respectively, to the *ring*, *lap*, and *wave* types of closed-coil windings. The derivation of the terms lap and wave winding will be evident from an inspection of Figs. 78 and 79; in the former, the successive elements lap back over each other, while in the latter they progress continuously in wave fashion around the periphery of the armature.

It will be noted that in both lap and wave windings the two sides of a coil or element are subjected to the influence of adjacent poles of opposite polarity, so that the e.m.fs. generated on the two sides add together. In a simple lap winding, the end of any element, say the x th, connects to the beginning of the $(x + 1)$ st element, and the beginning of the $(x + 1)$ st element lies under the same pole as the beginning of the x th element; in a wave winding, however, although the end of the x th connects to the beginning of the $(x + 1)$ st element, the latter is not under the same pole as the beginning of the x th element, but is separated from it by a double pole-pitch.

An examination of the directions of the current flow in Figs. 75, 76, and 77 will show that in the case of the first two diagrams there are four separate and distinct paths for the current through the winding ($a = 4$); each of these paths will carry one-fourth of the entire current supplied to the external circuit in the case of generator action, or supplied from the line in the case of motor action. In Fig. 77, on the other hand, though there are four poles as in the other machines, there are only two paths through the winding ($a = 2$). Other things being equal, therefore, the wave winding shown in the diagram will generate twice the e.m.f. of either of the other two in accordance with the fundamental equation

$$E = \frac{p}{a} \frac{\Phi Z n}{60 \times 10^8}$$

or, what amounts to the same thing, the same e.m.f. will be generated with only half the number of conductors required by a ring or lap winding. Furthermore, the diagrams show that four brushes are required in the cases of the ring and lap windings, while two will suffice in the case of the wave winding. These two facts in conjunction explain the reason for the use of wave windings in the case of direct-current railway motors, where the combination of the cramped space and the moderately high voltage require a minimum number of conductors; and no less important, considerations of accessibility for inspection and repairs limit the number of brush sets to two.

Lap and wave windings are often referred to as *parallel* and *series* windings, respectively.

66. Number of Brush Sets Required.—Inasmuch as the current in an element must undergo commutation once for each passage of the element through a neutral zone, it follows that the element may be short-circuited by a brush at each such reversal. Since the number of neutral zones and consequent reversals is equal to the number of poles, the number of permissible brush sets may in all cases be the same as the number of poles. In lap windings and in simple ring windings of the type shown in Fig. 75, the number of brush sets *must* be equal to the number of poles. But in wave windings, though p brushes *may* be used, two brushes will suffice irrespective of the number of poles. Thus, in Fig. 81, which shows a wave winding for a 6-pole machine having

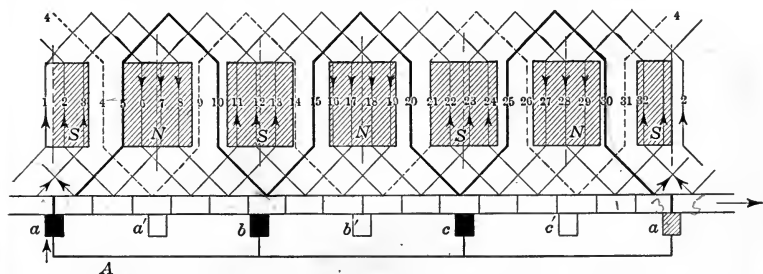

FIG. 81.—Six-pole wave winding, showing elements short-circuited by brush.

thirty-two armature conductors, any two of the three positive brushes a , b , and c may be omitted, as b and c (provided that a corresponding pair of negative brushes are removed at the same time), in which case the remaining brush, for example, brush a in Fig. 81, will short-circuit three elements in series when it spans two adjacent commutator segments. The three elements thus short-circuited by brush a are shown in heavy lines. Fig. 81 also makes it clear why two brushes instead of six, will suffice to collect the current, for it will be observed that brushes a , b and c are connected not only by the external conductor A but also by the short-circuited elements shown in heavy lines; these elements are in the neutral zone, consequently have little or no e.m.f. generated in them and are, therefore, equivalent to additional dead conductors joining the three brushes; hence conductor A and any two of the brushes a , b and c may be omitted. But if brushes b and c are retained, it will be observed that brushes

a , b , and c , which are connected together to form one terminal of the machine, operate in pairs to short-circuit single elements. This reduces the e.m.f. of self-induction to one-third of the value that would otherwise have to be handled, thereby improving commutation conditions.

67. Simplex and Multiplex Windings.—Degree of Reëtrancy.—If two identical ring-wound machines are connected in parallel as indicated in Fig. 82, the combined current output will be double that of either machine separately. The same result may be attained, together with economy in the use of material, by placing two independent windings on the same armature core, subjected to the magnetizing action of a single field structure, as indicated

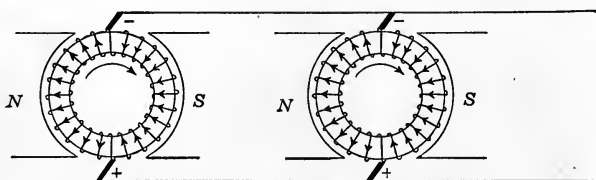

FIG. 82.—Armatures in parallel.

in Fig. 83. Here both the winding elements and the commutator segments of the independent windings are “sandwiched” or imbricated. The same result might also be secured by using two independent commutators, one at each end. Windings of the type of Fig. 83 are called *duplex* windings as distinguished from the *simplex* windings of Fig. 82 and those preceding it. Obviously, there is nothing to prevent the multiplication of independent windings so as to form *triplex*, *quadruplex*, etc., windings. In general, windings of this sort are called *multiplex*, to distinguish them from a simplex winding, in which each conductor must be passed through once, and only once, in tracing through its entire closed course.

Drum windings, both of the lap and wave varieties, may be treated in the same way as has here been described for the case of ring windings. It will be noted that the interleaving of the commutator segments of the component windings requires the use of brushes of sufficient width to collect the current from each pair of circuits at a neutral point.

The arrangement illustrated in Fig. 83 shows two independent

windings each containing twelve elements, or twenty-four in all. Suppose, now, that one of the twenty-four elements is omitted, and that the remaining twenty-three elements, uniformly spaced, are connected alternately, as in Fig. 84. Instead of having two independent windings, each closed upon itself, as in Fig. 83, there is now but a single closure; but a study of the direction of current flow, indicated by the arrow heads, will reveal the interesting fact that there are still four paths through the armature from brush to brush, just as in Fig. 83. In other words,

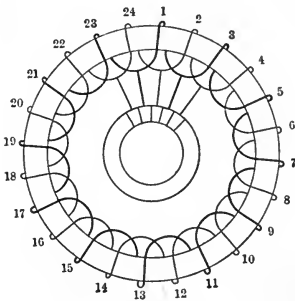

FIG. 83.

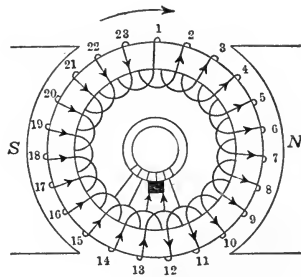

FIG. 84.

FIGS. 83 and 84.—Duplex armature windings.

both Figs. 83 and 84 illustrate duplex windings, but the former is *doubly reëntrant* while the latter is *singly reëntrant*. The *degree of reëntranc*y of a winding is, therefore, numerically equal to the number of independent, separately closed windings on the armature. Thus, it is possible to design windings as triplex, triply reëntrant; triplex, singly reëntrant; quintuplex, singly reëntrant, etc.

It should be understood that all of these conclusions apply with equal force to lap and wave drum windings, the ring type having been used in the above discussion solely for the sake of simplicity.

68. General Considerations.—The first systematic analysis of the relations to be satisfied in order that a symmetrical closed winding might result was the work of Professor E. Arnold of Karlsruhe, who published the result of his studies in 1891. The following derivation of the fundamental formulas is based upon that of Professor Arnold.

Probably the first questions that will present themselves to the student examining diagrams like those of Figs. 78, 79, and 81 are: How does one know in advance the number of coil edges to be stepped over in joining the end of one bundle of wires to the beginning of the next? Thus, in Fig. 81, the order is 1-6-11-16, etc.; would not some other order of connection do equally well? And what would be the effect of changing the total number of coil edges from 32 to some other number? The answer to these and related questions is implicitly involved in a general equation covering all kinds of closed windings; this equation is derived in a succeeding article.

69. Number of Conductors, Elements, and Commutator Segments.—Without regard to the number of turns per element, ring windings usually have only one active coil edge per element, while drum windings have as a rule two active coil edges per element. Further, in accordance with the definition of an element, there must be as many commutator segments, S , as there are elements. Consequently, in ring windings the number of commutator segments is equal to the number of active coil edges, while in drum windings the number of commutator segments is usually equal to half the number of coil edges. S must of course be an

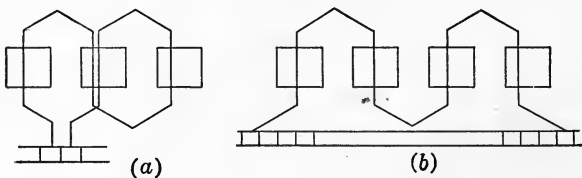

FIG. 85.—Elements having four active coil edges.

integer, but it may be either even or odd; therefore, in ring windings which have one turn per element and in which S is odd, the number of peripheral conductors may also be odd; but the number of elements in ring windings is usually made even, and more particularly in simplex windings a multiple of the number of poles in order that each branch path of the armature may be at all times identical with all of the others, in which case the number of conductors will be even. In drum windings, no matter whether S is even or odd, and irrespective of the number of turns per element, the number of conductors must be even.

Since the number of active conductors, Z , must be a simple multiple of the number of commutator segments, S , it follows that the study of the arrangement of conductors may be reduced to one involving the order of connections of the elements to the commutator, so that the quantity S is the factor of importance.

In certain drum windings it is desirable to reduce the number of commutator segments to a value smaller than that which corresponds to one segment for each pair of active coil sides. This can be accomplished in the manner indicated in Fig. 85, where each element has four active edges.

70. Winding Pitch, Commutator Pitch and Slot Pitch.—In Fig. 78 it will be observed that the back, or pulley, end of coil edge No. 1 is connected to the corresponding end of coil edge No. 8, and that the front, or commutator, end of No. 8 is connected to the front end of No. 3. The number of coil edges passed over in this way is called the *winding pitch*; thus, in Fig. 78, the *back pitch*, which will be designated by y_1 , is $+7$, while the *front pitch*, or y_2 , is -5 . In Fig. 79 both front and back pitches are positive and equal to 5.

Again, in Fig. 78, the beginning and end of each element are connected to adjacent commutator segments, whose numbers differ by unity. Similarly, in Fig. 79, the terminals of the elements are connected to segments which differ numerically by 5. This numerical difference between the terminal segments of an element is called the *commutator pitch*, y .

In slotted armatures the number of slots spanned by a coil or element is called the *slot pitch*.

Lap windings are right-handed or left-handed, respectively, depending upon whether y_1 is numerically greater or less than y_2 . In other words, if one faces the armature at the commutator end, the winding is right-handed if it progresses clockwise from segment to segment of the commutator in tracing through the circuit. On the other hand, wave windings are right- or left-handed according to whether one arrives at a segment to the right or left, respectively, of the starting point after tracing through $p/2$ elements, where p is the number of poles. Thus, in Fig. 81, the winding is left-handed.

The algebraic sum of the front and back pitches is a measure

of the total advance or retreat per element in tracing through the winding. In the case of lap windings,

$$\Sigma y = y_1 - y_2 = 2y \quad (1)$$

while in that of wave windings

$$\Sigma y = y_1 + y_2 = 2y \quad (2)$$

the factor 2 arising from the circumstance that each element has two coil sides. In cases where there are more than two coil edges per element, say n ,

$$\Sigma y = ny \quad (3)$$

or

$$y = \frac{\Sigma y}{n} = \frac{y_1 + y_2 + y_3 + y_4 + \dots + y_n}{n} \quad (4)$$

71. Field Displacement.—Reference to Figs. 78 and 79 will show that the terminals of each element of a winding are connected to segments which do not occupy corresponding positions with respect to the polar axes. There is a *field displacement* between them which may be expressed in terms of the number of commutator segments, m , by which the terminals fail to occupy homologous positions. Thus, in Fig. 78, $m = y = 1$, while in Figs. 83 and 84, $m = y = 2$. In wave windings, as Figs. 79 and 81 plainly show, the terminals of an element are separated by an interval approximately equal to a double pole pitch, but differing from the latter by an amount which is again a measure of the field displacement. Expressed in terms of commutator segments, the double pole pitch is $S \div \frac{p}{2}$, or $2S/p$, so that in this case

$$y = \frac{2S}{p} \pm m \quad (5)$$

In lap windings and in ordinary ring windings, m is necessarily an integer, but in wave windings m may be fractional ($\frac{1}{2}$, $\frac{1}{3}$, $\frac{1}{4}$, etc.). The sign of m determines whether the winding is right- or left-handed; obviously, if m is positive the winding is right-handed, while if it is negative the winding is left-handed.

72. Number of Armature Paths.—It has already been noted that simplex lap and ring (or parallel) windings always have as many paths through the armature as there are poles, while simplex wave windings (series) have but two paths, irrespective of

the number of poles. It remains to determine the relation existing between the number of paths and the winding and commutator pitches, since it will have been observed from Figs. 83 and 84 that the change of y from 1 to 2 changed the winding from simplex to duplex, that is, doubled the number of paths.

In the first place, it will be noted that in tracing through the winding from any arbitrary starting point, say a segment in contact with a negative brush, one complete path will have been passed over when the successive increments of the field displacement ($\pm m$) have brought the total displacement to a value equal to a pole pitch, S/p . This may easily be seen by referring to a simple ring winding like Fig. 75, but it is equally true for lap and wave windings. In the process of tracing through one path there will have been encountered a certain number, S' , of commutator segments (not necessarily an integral number), to each of which there corresponds a displacement m . The total displacement is then

$$mS' = \frac{S}{p}$$

or

$$\frac{S}{S'} = mp \tag{6}$$

Since S' segments have been encountered per path, the total number of paths must be

$$a = \frac{S}{S'} \tag{7}$$

which is necessarily integral, hence

$$a = mp$$

or

$$m = \frac{a}{p} \tag{8}$$

73. General Rules.—In the case of ordinary lap windings it has now been shown that

$$y = \frac{y_1 - y_2}{2} = \pm m = \pm \frac{a}{p} \tag{9}$$

while in the case of wave windings it is

$$y = \frac{y_1 + y_2}{2} = \frac{2S}{p} \pm m = \frac{2S \pm a}{p} \tag{10}$$

It will be noticed that these two expressions for y differ by the term $2S/p$, which represents a double pole pitch and expresses the fact that the terminals of a wave element having two active coil edges are separated by approximately that amount. In a winding like that of Fig. 85*b* the term $2S/p$ would be replaced by $4S/p$, and in general the numerical coefficient of S/p represents the *field step*, f , of the elements in terms of the number of single pole pitches included between their terminals. The end of a lap-winding element always occupies the same field zone as the beginning, so that $f = 0$ for lap windings. Quite generally, therefore,

$$y = \frac{fS \pm a}{p} = \frac{\Sigma y}{n} \tag{11}$$

From this general equation there may be deduced certain convenient rules for determining the order of connections of the coil edges, thereby fixing the design of the winding elements.

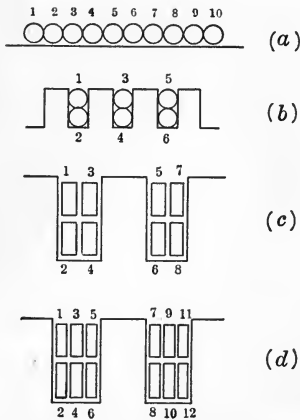

FIG. 86.—Standard numbering of coil edges.

edges, thereby fixing the design of the winding elements.

It has been pointed out in a previous section that the number of coil edges (nS) of a drum winding is necessarily even. If, then, the coil sides are numbered, half of them will bear even numbers and the other half odd numbers. Since each coil side proceeding outwardly from a commutator segment must have a return path through another coil edge, the numbering may be so arranged that the even numbers will constitute the

outgoing group while the odd numbers will comprise all of the return group. This means that even-numbered coil edges will be connected to odd-numbered coil edges at both ends, therefore, *front and back pitches must be odd*. This is a general rule for all drum windings provided the numbering is carried out in accordance with the system indicated in Fig. 86.

1. LAP OR PARALLEL WINDINGS.—An examination of the formula $y = \pm \frac{a}{p}$ shows that there are no restrictions upon the

number of elements, which may, accordingly, be even or odd. In the great majority of commercial windings there are only two coil sides per element ($n = 2$), so that

$$y_1 - y_2 = 2y = \pm 2 \frac{a}{p} = \pm 2m$$

from which it follows that *the pitches must differ by twice the degree of multiplicity* in addition to their being odd. There remains the further condition that both y_1 and y_2 must not differ too greatly from the pole pitch, $\frac{2S}{p}$, as otherwise the e.m.fs. of the connected sides will not be effectively additive. It is not essential that the average pitch approximate $\frac{2S}{p}$ so far as mere closure is concerned, and in certain so-called *chord* windings or *fractional pitch* windings the average pitch is purposely made larger or smaller than this value.

As an example of these rules, it may be observed that in Fig. 78

$$\begin{array}{ccccccc} Z = 22 & S = 11 & p = 4 & a = 4 & & & \\ y = m = \frac{a}{p} = 1 & y_1 - y_2 = 2y = 2 & y_1 = 7 & y_2 = 5 & & & \end{array}$$

Had the pitches been made 9 and 7, respectively, or 5 and 3, the winding would close, but it would be an exaggerated form of chord winding.

Since $m = \frac{a}{p} = y$, it follows that in an *m-plex lap winding* the *commutator pitch equals the degree of multiplicity*. Thus, in a simplex lap winding the ends of an element are connected to adjacent segments; in a duplex winding they are separated by one segment, etc.

2. WAVE OR SERIES WINDINGS.—The general formula

$$y = \frac{fS \pm a}{p}$$

reduces to $y = \frac{y_1 + y_2}{2} = \frac{2S \pm a}{p}$ for most commercial windings of this type. It is clear that the choice of S , and therefore of the number of active conductors, is not unlimited as in lap windings. In Fig. 81, for instance, which represents a simplex wave winding for a 6-pole machine, $a = 2$, $p = 6$, $2S = 32$, hence $y = \frac{32 \pm 2}{6}$

= 5 or $5\frac{2}{3}$. The latter value of y being impossible, we must take $y = 5$. Since the pitches must approximate $\frac{2S}{p} = 5\frac{1}{3}$, select $y_1 = y_2 = 5$, though values of 7 and 3 would result in a closed chord winding.

The restriction upon the number of elements in wave windings frequently causes the use of "dummy coils." Suppose, for example, it is necessary to design a simplex 4-pole wave winding to be placed on an armature core having 65 slots, each slot being of sufficient size to accommodate four coil sides, in the manner of Fig. 86c. This means that $Z = 260$, assuming each coil edge to consist of a single conductor, and of course this value of Z must accord with the fundamental equation (17, Chap. II). Summarizing, $2S = 260$, $a = 2$, $p = 4$; whence

$$y = \frac{260 \pm 2}{4} = 64\frac{1}{2} \text{ or } 65\frac{1}{2}$$

But since y must be an integer, the value of $2S$ nearest to 260 that will satisfy the equation is 258 ($2S = 262$ is impracticable because the maximum number of coil edges that can be placed in the slots is 260). Taking $2S = 258$, it follows that there must be one element, consisting of two conductors, that is not a part of the winding; it is put in simply to fill up the space in the two slots which contain only three active conductors each. Therefore, $y = \frac{258 \pm 2}{4} = 64$ or 65. Since y_1 and y_2 must be odd, and further $\frac{y_1 + y_2}{2} = y$, the following pairs of pitch values are possible:

$$\left\{ \begin{matrix} y_1 = 65 \\ y_2 = 65 \end{matrix} \right\} \left\{ \begin{matrix} y_1 = 63 \\ y_2 = 67 \end{matrix} \right\} \left\{ \begin{matrix} y_1 = 67 \\ y_2 = 63 \end{matrix} \right\} \left\{ \begin{matrix} y_1 = 65 \\ y_2 = 63 \end{matrix} \right\} \left\{ \begin{matrix} y_1 = 63 \\ y_2 = 65 \end{matrix} \right\} \text{ etc.}$$



FIG. 87.—Numbering of coil edges.

Practical considerations in this particular case dictate the use of $y_1 = 65$. For if the coil edges are numbered in accordance with Fig. 86, it will be seen from Fig. 87 that the back ends of

conductors 1 and 3 may then be joined to conductors 66 and 68, respectively, thereby allowing the conductors to be insulated together in pairs and facilitating the placing of the bundles in the slots.

In wave windings the field displacement is given by $m = \frac{a}{p}$, so that after tracing through $p/2$ elements, corresponding to one circuit of the periphery, the total displacement is $\frac{p}{2} \times \frac{a}{p} = \frac{a}{2}$ commutator segments. Therefore, in simplex windings ($a = 2$) the end of the $p/2$ th element connects to a segment adjacent to the starting segment; in duplex windings it connects to the next but one, etc.

3. SERIES-PARALLEL WINDINGS.—The ordinary wave winding results in but two paths ($a = 2$) through the armature irrespective of the number of poles. But it is possible to secure any multiple of this number of paths by a suitable choice of S in the general formula. Wave windings having more than two paths are called *series-parallel* windings. Thus, if a 6-pole armature has 154 conductors wound to form 77 elements, it may be arranged as a 4-circuit (duplex) wave winding; substituting $f = 2$, $S = 77$, $a = 4$, and $p = 6$ in the equation $y = \frac{fS \pm a}{p}$, there results $y = 25$.

74. General Rule for the Degree of Reëtrancy.—If, in the general formula,

$$y = \frac{fS \pm a}{p}$$

the two sides of the equation have a common factor q , we have

$$\frac{y}{q} = \frac{f \frac{S}{q} \pm \frac{a}{q}}{p}, \text{ or } y' = \frac{fS' \pm a'}{p} \quad (12)$$

which means that the original winding is really made up of q independent windings, each of which has $S' = \frac{S}{q}$ elements and a commutator pitch of y' , the latter counted with respect to the S' segments. That is, the winding will be multiplex and multiply reëtrant of the q th degree in the event that y and S have a

common factor q ; it will be singly reëntrant if y and S are prime to each other.

In ordinary duplex wave windings ($f = 2$)

$$y = \frac{2S \pm 4}{p} = \frac{2(S \pm 2)}{p}$$

from which it follows that if y is even, that is, contains 2 as a factor, S must also be even because $\frac{S \pm 2}{p}$ must be an integer and p is always an even number. This leads to the simple rule that a *duplex wave winding is doubly reëntrant if y is even*; and to the corollary that it is singly reëntrant if y is odd.

In triplex wave windings in which $f = 2$,

$$y = \frac{2S \pm 6}{p} = \frac{2(S \pm 3)}{p} \quad (13)$$

Suppose now that y contains 3 as a factor, in which case $y = 3x$, where x is an integer; then from (13)

$$3x \cdot \frac{p}{2} = S \pm 3$$

$$\frac{p}{2} x = \frac{S}{3} \pm 1$$

Therefore, since $\frac{p}{2} \cdot x$ is integral, S must be a multiple of 3, hence the winding is triply reëntrant. Hence a *triplex wave winding will be triply reëntrant if y is a multiple of 3*, and it will be singly reëntrant if y is not a multiple of 3.

In the case of quadruplex wave windings, however, such simplifications of the general rule are not possible. Such windings may be singly, doubly, or quadruply reëntrant. Thus, if $f = 2$, $a = 8$, and $p = 6$, $S = 79$ leads to a singly reëntrant winding in which $y = 25$; $S = 82$ results in a doubly reëntrant winding, $y = 26$; and $S = 80$ gives quadruple reëntrancancy, $y = 28$.

75. Two-layer Windings.—An inspection of any of the windings of Figs. 78, 79, 81, etc., will show that the end connections of successive conductors proceed alternately in opposite directions. If all of the conductors lay in the same cylindrical surface, as in the case of smooth core armatures, the crossing of the end connections would make the actual winding process difficult of execution. But where slotted armatures are used, if the conductors

are arranged in two layers, the end connections of the upper layer may all proceed in one direction while the end connections of the lower layer, at the same end of the armature, may all proceed in the opposite direction, as in Fig. 88. Since the upper and lower

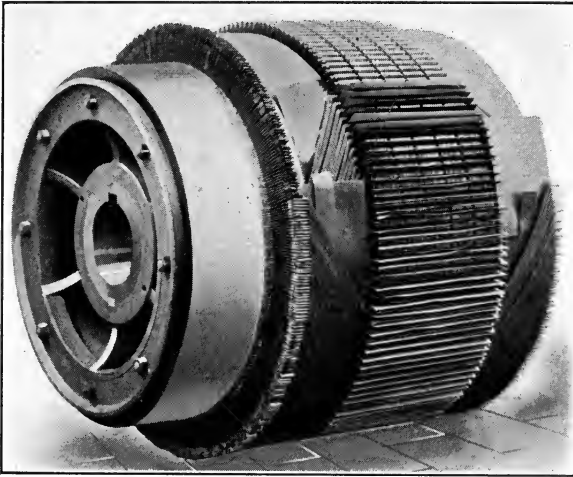

FIG. 88.—Partially wound drum armature (lap winding).

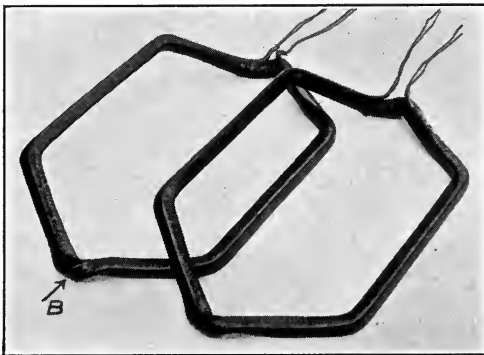

FIG. 89.—Samples of winding elements.

layers include all the odd and even numbered coil sides, respectively, conductors in the top layer must connect to others in the lower layer, the transition being effected by the peculiar bend in the coil shown at *B*, Fig. 89.

It is easy to recognize an armature as lap or wave wound, when the conductors are made of bars or strips of copper, by observing the relative directions of the top end-connections at the two ends

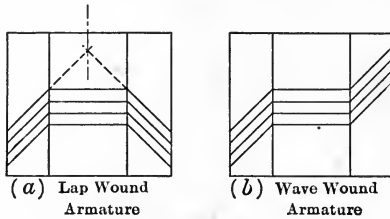

FIG. 90.—Showing direction of end connections in lap and wave windings.

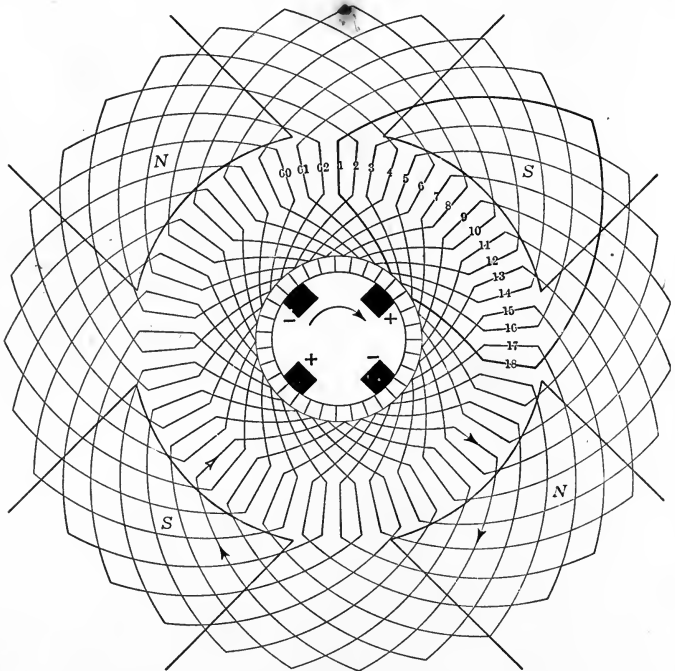

FIG. 91.—Duplex lap winding, singly reentrant. $Z = 62, S = 31, y = 2,$
 $y_1 = +17, y_2 = -13.$

of the armature. Thus, if the top end-connections, when produced, meet at or near the center of the core, as in Fig. 90a, the winding is a lap winding; whereas if the top end-connections are parallel, as in Fig. 90b, the winding is a wave winding.

76. Examples of Drum Windings.—Figs. 91 to 94, inclusive, show clearly how a slight change in the number of coil edges will change the winding from single reëtrancy to multiple reëtrancy. Thus, in Figs. 91 and 92, although both windings (duplex lap) have identical pitches, the former, with 62 coil edges, is singly reëtrant, while the latter, with 64 coil edges, is doubly reëtrant. Electrically, however, these windings have identical properties,

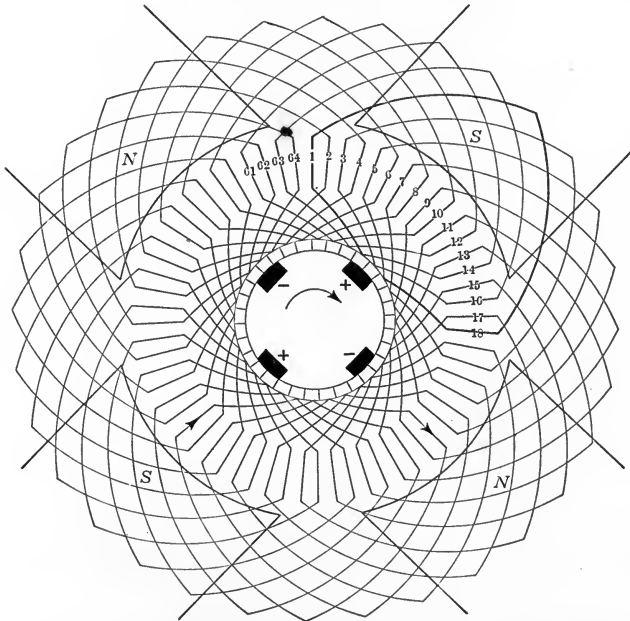

FIG. 92.—Duplex lap winding, doubly reëtrant. $Z = 64, S = 32, y = 2,$
 $y_1 = +17, y_2 = -13.$

except for the slight difference in e.m.f. due to the different number of active conductors. Similar remarks apply to Figs. 93 and 94, which show singly- and doubly-reëtrant duplex wave windings. Note that in Fig. 93 the pitches (y, y_1 and y_2) equal 17, but that pitches of 15 would also work out correctly; and that in Fig. 94 it would also be possible to design the winding with pitches of $y = 14, y_1 = 15, y_2 = 13.$

77. Equipotential Connections.—Consider a parallel-wound armature like Fig. 95, which represents diagrammatically a

winding for an 8-pole machine. The eight parallel paths through the armature from terminal to terminal are shown somewhat more clearly in their relations to one another in the diagram of Fig. 96. It will at once appear that if each path is to carry its proportionate share of the total armature current, each path must at all times generate the same e.m.f. and have the same resistance as all the other paths. In any case, the current will divide between the eight paths in accordance with Kirchoff's

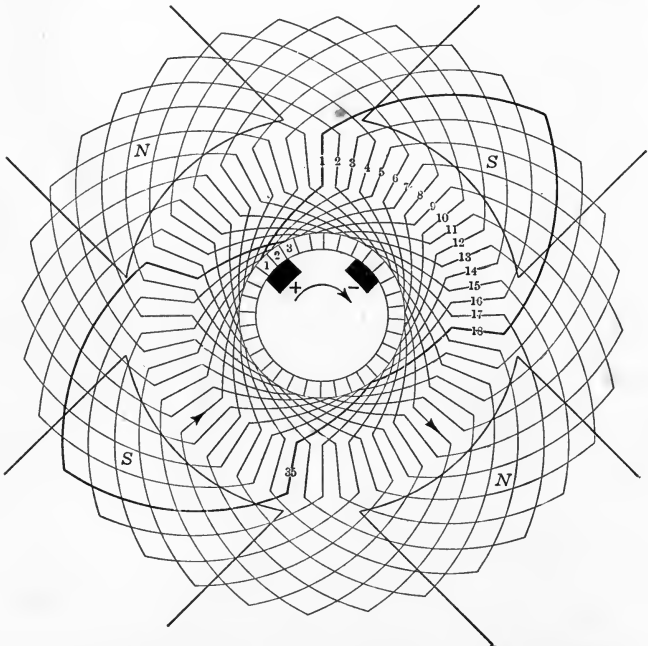

FIG. 93.—Duplex wave winding, singly reentrant. $Z = 64$, $S = 32$, $y = y_1 = y_2 = 17$.

laws for divided circuits, namely: (1) the summation of all the potential differences in each closed circuit must be zero; (2) the sum of all currents meeting at a point must be zero. If for any reason the e.m.f. generated in one path is greater than in another, for instance, if that of circuit 3-2' is greater than that of 3-3', the brushes 2' and 3' will not have the same potential and an equalizing current will flow in the lead joining brushes 2' and 3'. Even very small differences of potential may give rise to internal

equalizing currents of large magnitude, owing to the low resistance of the circuits, so that excessive heating of the winding and sparking at the brushes may result if preventive measures are not employed.

The causes of possible unequal e.m.fs. in the various paths are as follows:

1. The armature may not be exactly centered with respect to the pole shoes, due to natural irregularities in construction or to

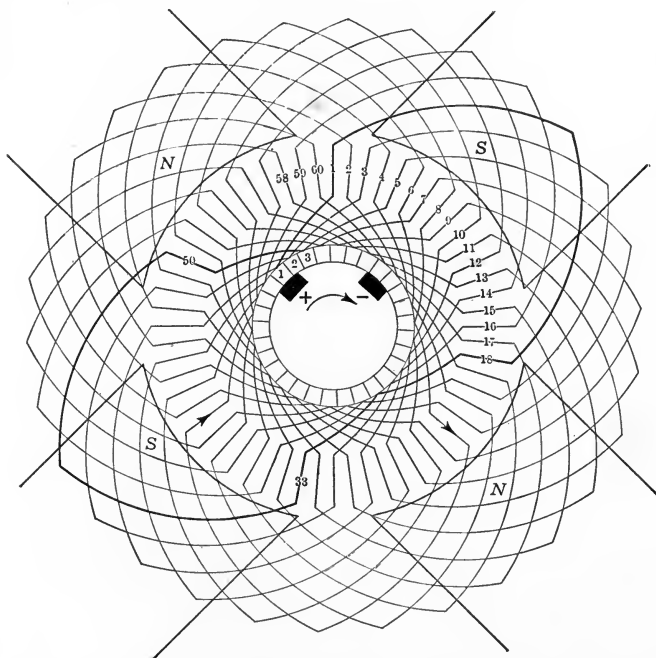

FIG. 94.—Duplex wave winding, doubly reentrant. $Z = 60$, $S = 30$,
 $y = 16$, $y_1 = 17$, $y_2 = 15$.

wear of the bearings. The air-gap is consequently not uniform, and some of the poles therefore carry more flux than others, thereby generating more e.m.f. in the coils subject to their influence than is generated in coils under the weaker poles. This cause is of importance in lap and ring windings, where each armature circuit is at any one time under the influence of one pole only; in wave windings each path is simultaneously acted

upon by all of the poles, hence this type of winding is free from the disturbing effect of non-uniform polar flux.

2. The poles may not all be identical in construction, so that their fluxes may differ even if the air-gap is uniform. Thus, the joints between the poles and the yoke, or between the pole cores and the shoes, may not all be equally good, or the magnetizing effect of

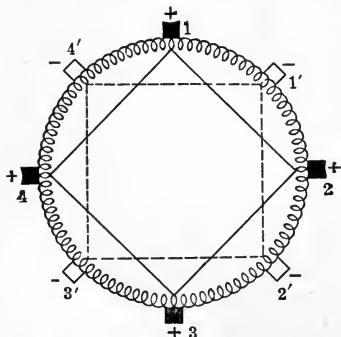

FIG. 95.—Parallel-wound armature with equalizer connections.

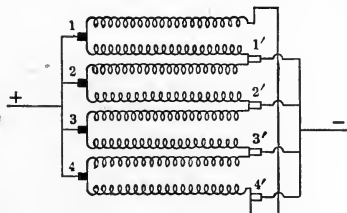

FIG. 96.—Diagrammatic scheme of connections of armature of Fig. 95.

the field windings may differ, especially in cases where the field coils are connected in parallel instead of in series.

3. The armature circuits may be unsymmetrical, due to a choice of number of elements which is not an exact multiple of the number of paths. In this connection it should be observed that in multiplex windings there is always dissymmetry between the circuits, due to the fact that the

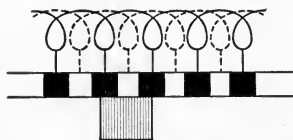

FIG. 97.—Short-circuiting of elements of multiplex winding.

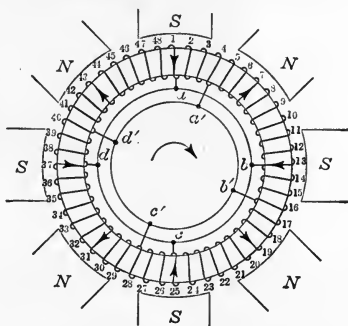

FIG. 98.—Equalizer connections in parallel winding.

brushes short-circuit an unequal number of elements of the component windings (Fig. 97). This kind of asymmetry will give rise to equalizing currents even if the individually generated e.m.fs. are equal, because the circuits have slightly different resistances.

The equalizing currents are a source of loss because of the

extra heating caused by them. This effect can be minimized by striving for the greatest possible degree of magnetic and electrical symmetry. To obviate the remaining difficulty of sparking at the commutator, resort is had to the use of *equipotential connections*, which are low-resistance conductors joining points in the winding which, under ideal conditions, would at all times have the same potential. Thus, in Fig. 98, the points *a, b, c, d*, and *a', b', c', d'*, etc., are always under the influence of corresponding parts of poles of like sign. Should irregularities exist, equalizing current

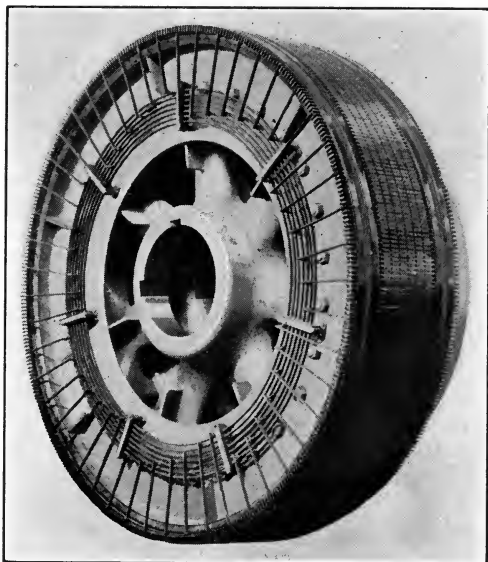

FIG. 99.—Equalizing rings of large lap-wound armature.

will flow through these connections, relieving the brushes of the extra current and preventing sparking. The equalizing current is of course an alternating one. The equipotential connections, occasionally referred to as the equalizing rings, are sometimes placed between the commutator and the armature core under the end connections; in large drum armatures they are generally mounted on the exposed side of the core as in Fig. 99.

When the equipotential connections were first introduced by Mordey they were intended to reduce the usual number of brush sets. Thus, it is clear from Fig. 98 that two brushes might be

expected to take care of the entire current, since the commutator segments that would be touched by three of the brushes of one polarity are already connected to the fourth brush by the equalizing connections. The difficulty arising from the use of only two brushes is that all of the armature circuits are not identically situated with respect to the line terminals, the extra resistance of the equalizing connections between the remote armature paths and line being sufficient to introduce an unbalancing of the circuits. In present practice the number of brush sets is not reduced when equalizing connections are used.

PROBLEMS

1. Make a drawing of a simplex lap winding for a 4-pole drum armature having 48 coil edges, using the kind of diagram shown in Fig. 91. Use pitches of + 13 and - 11. Show position of brushes and indicate direction of current flow in the winding.

2. Make a drawing of a simplex wave winding for a 4-pole drum armature having 46 coil edges, using the kind of diagram shown in Fig. 93. Use front and back pitches of + 11. Show position of brushes and indicate direction of current flow in the winding.

3. Make a table showing the order of connections of the coil edges of the winding of Problem 2 if the front pitch is + 11 and the back pitch + 13.

4. A 6-pole drum armature has 450 coil edges. Find all possible lap and wave windings, up to and including triplex windings, that are possible; give front, back and commutator pitches and degree of reëtrancy in each case. Assume that each element has two active coil edges.

5. The armature core of a 4-pole 110-volt generator has 63 slots each of sufficient size to accommodate 4 conductors. If the flux per pole is approximately 10^6 lines and the speed of the machine is 1300 r.p.m., how many conductors are necessary, and how must they be wound? State pitches.

6. A 4-pole generator has a rating of 15 kw. at 125 volts and 1200 r.p.m. The diameter of the armature is 12 in., the length of armature core is 5 in., and the pole arc is 70 per cent. of the pole pitch. The armature has 47 slots, each containing 4 conductors, and there are 47 commutator segments. Knowing that the flux density under the pole faces does not exceed 55,000 lines per sq. in., how many parallel paths are there through the armature? Find the type of the winding, and the winding and commutator pitches.

7. A 6-pole duplex wave winding has 127 elements each having two turns. The mean length of one complete turn is 37.5 in. and the conductors have a cross-section of 60,000 circular mils (a circular mil is the area of a circle which has a diameter of 1 mil, a mil being the thousandth part of an inch). If the specific resistance of copper at the running temperature is 12 ohms per circular mil-ft., what is the resistance of the armature measured between brushes?

CHAPTER IV

THE MAGNETIZATION CURVE. MAGNETIC LEAKAGE

78. The Magnetization Curve.—Every dynamo consists of an electrical circuit interlinked with a magnetic circuit. The armature winding is the electrical circuit in which the e.m.f. is produced in the case of a generator and in which the working current produces the torque in the case of a motor. In either case, the activity of the armature is dependent upon the magnitude of the magnetic flux, and the latter, in turn, is dependent upon the magnetizing effect of the field winding and the reluctance of the magnetic circuit in accordance with the relation

$$\text{Flux} = \Phi = \frac{\text{m.m.f.}}{\text{reluctance}}$$

Since

$$E = \frac{p}{a} \frac{\Phi Z n}{60 \times 10^8}$$

it follows that

$$E = \frac{p}{a} \frac{Z n}{60 \times 10^8} \cdot \frac{\text{m.m.f.}}{\text{reluctance}}$$

which means that E is a function of the field excitation; the graph of this function is called the *magnetization curve*, or the saturation curve, or the no-load characteristic.

If the magnetic circuit had constant reluctance, the no-load characteristic would be a straight line through the origin, but since the permeability of the iron of the magnetic circuit falls off as the flux increases, the flux does not bear a constant ratio to the m.m.f.; the result is that the no-load characteristic droops below the straight line form, as indicated in Fig. 100.

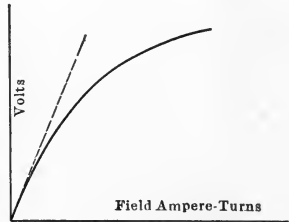

FIG. 100.—Magnetization curve of a dynamo.

The dashed lines in Figs. 101 and 102 represent the mean paths of the flux in typical forms of bipolar and multipolar ma-

chines. These lines are so drawn that they pass through the centers of gravity of the sections of the tubes of induction. It will be observed that a complete path or magnetic circuit, such as C' , Fig. 102, includes the armature core, two sets of teeth, two air-gaps, two pole shoes, two pole cores, and the connecting yoke. A magnetizing winding P on one pole will set up the same flux in each of the paths C and C' (assuming perfect symmetry of construction) since these paths are in parallel. A similar winding on every *alternate* pole would then magnetize all the poles equally, hence the excitation required to drive the flux through a complete magnetic circuit is the excitation *per pair of poles*.

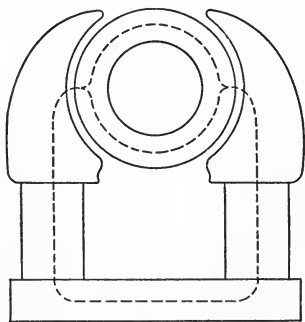

FIG. 101.—Magnetic circuit of bipolar machine.

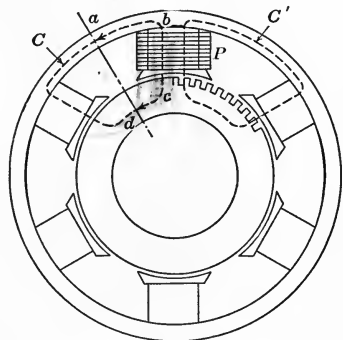

FIG. 102.—Magnetic circuits of a multipolar machine.

The excitation per pole is, therefore, that required to maintain the flux in a magnetic circuit such as $abcd$, Fig. 102, consisting of a single air-gap, one set of teeth, one pole shoe and core, and half of the connecting circuit through the armature core and the yoke. Field excitation is generally expressed in terms of the number of ampere-turns per pole; or in terms of ampere-turns per pair of poles.

The magnetization curve is of great importance. Whether the machine is to be used as a generator or as a motor, the form of the magnetization curve will largely determine its operating characteristics. Conversely, a given set of specifications will in large measure fix the form of the magnetization curve. It is, therefore, apparent that the determination of this curve is of fundamental importance. In the case of a completed machine the magnetiza-

tion curve can be determined experimentally; it can also be calculated when the dimensions of the machine and the nature of the materials used in its construction are known.

79. Experimental Determination of Magnetization Curve.— Since

$$E = \frac{p}{a} \frac{Zn}{60 \times 10^8} \cdot \frac{\text{m.m.f.}}{\text{reluctance}} = kn \times \text{function of field ampere-turns} \quad (1)$$

it is clear that it is only necessary to run the machine at a constant speed n (driving it with a motor or other suitable prime mover) and to observe a series of simultaneous pairs of values of E and ampere-turns. \times In the above equation (1) E is the e.m.f. generated in the armature by rotation through the flux produced by the field current; therefore, to measure E directly, the armature must be without current, that is, it must be on open circuit. The machine must then be separately excited during this test, as in Fig. 103, current being supplied to the field winding from a suitable external

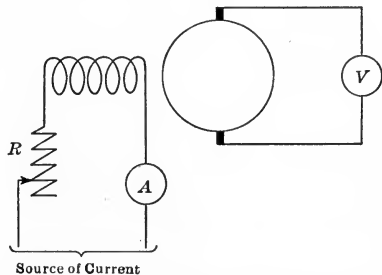

FIG. 103.—Experimental determination of magnetization curve.

source, controlled by a variable resistance R and measured by an ammeter A . The procedure then consists of varying the current A by means of R , and taking a reading of voltmeter V for each setting of A , the speed being kept constant throughout.

\times Inspection of equation (1) indicates that with a fixed value of field excitation the generated e.m.f. E would be directly proportional to the speed. This is, however, not quite true; for it is possible that current may flow in those elements of the armature winding which are short-circuited by the brushes, and these short-circuit currents may easily reach values of sufficient magnitude to react upon the flux and so affect the generated e.m.f. To reduce the disturbing effect of these short-circuit currents to a minimum, it is necessary to cut down the e.m.f. which gives rise to them, and, with a given field excitation, this can be done by reducing the speed. It is best, therefore, to determine the

magnetization curve at a speed considerably below the rated speed, and then to multiply the observed voltage by the ratio of rated speed to the speed actually used. The effect of the current in the short-circuited coils of the armature is discussed in more detail in Chap. VIII.

The form of the magnetization curve obtained experimentally is not the same if the exciting current in the field winding is first

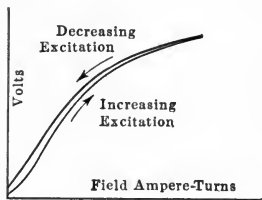

FIG. 104.—Effect of hysteresis on magnetization curve.

gradually increased from zero to a maximum and then gradually reduced from this maximum back again to zero. The observed readings when plotted take the form of Fig. 104.

The difference between the two curves is due to the *hysteresis* of the iron part of the magnetic circuit, hysteresis being the name given to that property of iron (or other magnetic substance) by virtue of which the induced magnetism lags behind changes in the magnetizing force.

The difference between the two curves is due to the *hysteresis* of the iron part of the magnetic circuit, hysteresis being the name given to that property of iron (or other magnetic substance) by virtue

80. Calculation of the Magnetization Curve.—To analyze the method of computing the coordinates of points on the magnetization curve, the following symbols will be used:

Part of circuit	Cross-section	Length of path	Flux density	Amp.-turns per unit length	Total amp.-turns
Armature core.....	A_a	l_a	B_a	at_a	AT_a
Teeth, one set.....	A_t	l_t	B_t	at_t	AT_t
Air-gap, single.....	A_g	δ	B_g	at_g	AT_g
Pole shoe, single.....	A_s	l_s	B_s	at_s	AT_s
Pole core, single.....	A_c	l_c	B_c	at_c	AT_c
Yoke.....	A_y	l_y	B_y	at_y	AT_y

The total ampere-turns per pair of poles will then be

$$AT = AT_a + 2AT_t + 2AT_g + 2AT_s + 2AT_c + AT_y \quad (2)$$

Since for any path x

$$H_x = \frac{4\pi}{10} \frac{AT_x}{l_x}$$

(all quantities being expressed in c.g.s. units), the requisite number of ampere-turns for the length l_x is

$$AT_x = \frac{10}{4\pi} H_x l_x = 0.8H_x l_x$$

But

$$\frac{10}{4\pi} H_x = \frac{AT_x}{l_x} = at_x = \text{ampere-turns per cm.}$$

$$\therefore AT = at_a.l_a + 2at_l.l_l + 2at_g.\delta + 2at_s.l_s + 2at_c.l_c + at_y.l_y \quad (3)$$

The magnetization (B - H) curves of magnetic materials are usually plotted in terms of B and at (the latter being simply $0.8H$), so that when the values of B for the various parts of the circuit have been determined, the corresponding values of at may be read from the curve and substituted in the expression for AT . Fig. 20 shows magnetization curves for the usual commercial materials, the coordinates being plotted in terms of metric and also of English units. If English units are used, the expression for AT becomes

$$AT = at''_a.l''_a + 2at''_l.l''_l + 2at''_g.\delta'' + 2at''_s.l''_s + 2at''_c.l''_c + at''_y.l''_y \quad (4)$$

The general method of calculating the coordinates of points on the magnetization curve then consists of assuming a number of values of the generated e.m.f. E , ranging from about a quarter of full-load value to, say, 25 per cent. in excess of that value. To each value of e.m.f. thus selected there will correspond a value of flux, Φ , as determined by the equation $\Phi = \frac{a}{p} \frac{E}{Zn} \times 60 \times 10^8$, this value of Φ then fixing the flux density, B_x , in each part, x , of the circuit. Having determined B_x , at_x is found from Fig. 20, whence

$$AT = \sum_C at_x.l_x$$

the summation being extended over a complete closed circuit, such as C , Fig. 102.

81. Magnetic Leakage.—The flux per pole, Φ , may be designated the useful flux, since it is this flux which is involved in the production of the generated e.m.f. But the entire flux produced by the magnetizing action of the field winding does not penetrate the armature, an appreciable part of it “leaking” across from

pole to pole, and in general between all points which have between them a difference of magnetic potential. This "leakage flux," φ , increases the total flux from Φ to

$$\Phi_t = \Phi + \varphi$$

The ratio

$$\frac{\Phi_t}{\Phi} = 1 + \frac{\varphi}{\Phi} = \nu \quad (5)$$

is called the leakage coefficient, or preferably, the *coefficient of dispersion*. It is always greater than unity, and in machines of the usual radial multipolar type ranges from about 1.1 to 1.25, the larger values corresponding to small machines. Since the leakage flux must traverse the poles and yokes, the cross-section of these parts must be sufficiently large to carry it as well as the useful flux, hence the necessity of keeping down leakage as much as possible. The conditions to be satisfied to attain this end are, accordingly, minimum reluctance of the main magnetic circuit and maximum reluctance of leakage paths; this means, practically, a compact magnetic circuit made up of short poles, the interpolar spaces being wide and of small section.

The magnitude of the coefficient of dispersion is not constant for a given machine under all conditions. The leakage flux, φ , being mainly in air, is very nearly proportional to the m.m.f., while Φ is less and less proportional to the m.m.f. as the saturation of the iron is increased. In general, therefore, $\nu = 1 + \frac{\varphi}{\Phi}$ increases more or less with increasing excitation.

Methods for the calculation of the coefficient ν will be given in a subsequent section. For the present it will suffice to state that ν is a function of the dimensions of the machine. This introduces a difficulty in a new design because the flux densities, etc., cannot be determined until the dimensions have been decided upon, and the dimensions are themselves dependent upon Φ_t and, consequently, also upon ν . It is therefore necessary in such a case to assume a value of ν in accordance with previous experience, proceeding then to the calculation of Φ_t and the dimensions. The true value of ν can then be calculated and the tentative computations modified in case the discrepancy is sufficiently large to warrant a readjustment.

82. Details of Calculation of Magnetization Curve.—

1. AMPERE-TURNS REQUIRED FOR THE AIR-GAP.—The great permeability of iron as compared with air is responsible for the fact that the reluctance of the air-gap often constitutes from 70 to 90 per cent. of the entire reluctance of the magnetic circuit. The accurate determination of the excitation consumed in the air-gap is, therefore, of predominant importance.

Two different cases arise in practice: (a) smooth core armatures, and (b) slotted armatures.

(a) *Smooth Core Armatures.*—In a machine having p poles, the angle subtended by the pole-pitch is $\frac{2\pi}{p}$. The angle β subtended by the pole shoe is usually between 0.55 and 0.7 of $\frac{2\pi}{p}$; the quantity $\frac{\beta \times 100}{2\pi/p}$ is called the per cent. of polar embrace. If the flux crossed the air-gap along radial lines, the determination of B_g

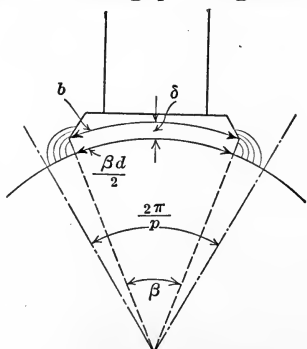

FIG. 105.—Fringing flux at pole tips.

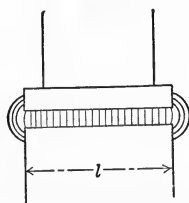

FIG. 106.—Spread of flux at flanks of pole shoes.

and AT_g would be very simple; actually, however, the flux spreads out beyond the pole tips, as indicated in Fig. 105, and there is a further spreading at the flanks, as illustrated in the side elevation, Fig. 106. *The flux always distributes itself in such a way that the total reluctance is a minimum.* The spreading of the flux is equivalent to an increase in the length of the polar arc from b to b' , and an increase in the axial length from l to l' . The mean flux density in the gap is then

$$B_g = \frac{\Phi}{b'l'} \quad (6)$$

and since in air $B = H$, it follows that

$$AT_g = 0.8B_g\delta \quad (7)$$

all dimensions being in centimeters. If the inch is taken as the unit of length,

$$AT_g = 0.8 \frac{B_g''}{(2.54)^2} (\delta'' \times 2.54) = 0.3133B_g''\delta'' \quad (8)$$

For practical purposes it is sufficiently accurate to take b' as the average of the polar arc b , and of the arc on the armature subtended by the angle β and increased by 2δ on each side; that is,

$$b' = \frac{1}{2} \left[b + \left(\frac{\beta d}{2} + 4\delta \right) \right] = \frac{\beta}{2} (d + \delta) + 2\delta \quad (9)$$

Similarly, l' may be taken as

$$l' = l + 2\delta \quad (10)$$

in case the axial lengths of pole shoes and armature core (between heads) are the same. If these lengths are not equal, let them be represented by l_s and l , respectively; then $b'l'$ in the above equation for B_g should be replaced by an area A_g such that

$$A_g = \frac{A'_g + A''_g}{2} \quad (11)$$

where A'_g is the area of the pole shoe and A''_g is the area on the armature core threaded by the flux. Obviously

$$A'_g = bl_s \quad (12)$$

and

$$A''_g = \left(\frac{\beta d}{2} + 4\delta \right) l \quad (13)$$

(b) *Slotted Armatures.*—In this case the calculation of B_g is complicated by the fact that the flux tends to tuft at the tips of

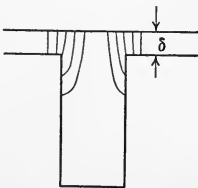

FIG. 107.—Fringing flux at tooth tip.

the teeth, and that more or less of it enters the teeth by way of the slots, as indicated in Fig. 107. It is clear that a given difference of magnetic potential between the pole face and the armature core will produce less flux when slots are present than when the armature surface is smooth, the clearance (δ) being the same in both cases. In other words, the slots increase the gap reluctance, and this effect may be allowed for

either by assuming δ to have been increased to a larger value, or by assuming a contraction of the pole arc b to a smaller value, b' .

The problem is further complicated by the fact that the air-gap is frequently not of uniform length over the entire pole face. To improve commutation it is common to chamfer the pole tips, Fig. 108*a*, or to make the cylindrical surfaces of the armature and pole face eccentric, Fig. 108*b*. The effect of the increased gap length at the pole tips is to produce a fringing flux in the inter-

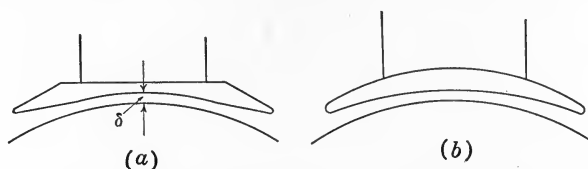

FIG. 108.—Chamfered and eccentric pole shoes.

polar space, as shown by the flux distribution curve of Fig. 109. Ordinates of this curve represent the radial component of flux density at corresponding points on the armature periphery. The ripples at the crest of the curve are caused by the slots and teeth.

Similarly, there is a fringing field at the ends of the core, as shown in Fig. 110, and if ventilating ducts are provided, there will be dips in the curve of axial flux distribution corresponding

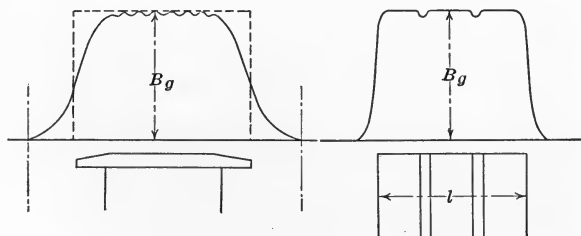

FIG. 109.

FIG. 110.

FIGS. 109 and 110.—Peripheral and axial distribution of field intensity.

to the depressions opposite the slots, just as in Fig. 109. The extra reluctance due to the ventilating ducts is equivalent to a reduction in the axial length l , and the fringing at the flanks is equivalent to an increase in l , so that the two effects tend to neutralize each other.

83. Correction to Pole Arc.—It has been shown by F. W.

Carter¹ that the presence of slots increases the effective length of the air-gap from δ to δ' , where

$$\delta' = \delta \frac{t}{t - \sigma b_s} \tag{14}$$

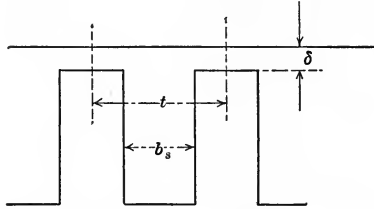

FIG. 111.—Dimensions of teeth and slots.

and where

t = tooth pitch

b_s = width of slot opening

and

$$\sigma = \frac{2}{\pi} \left[\arctan \frac{b_s}{2\delta} - \frac{\delta}{b_s} \log_e \left(1 + \frac{b_s^2}{4\delta^2} \right) \right] \tag{15}$$

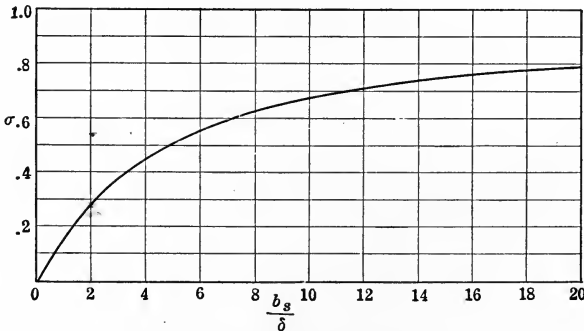

FIG. 112.—Correction factor, σ .

If, however, the effect of the slots is taken into account by reducing the pole arc instead of lengthening the gap, it follows that

$$b' = b \frac{t - \sigma b_s}{t}$$

¹ Air-gap Induction, Elec. World, Vol. XXXVIII, p. 884, 1901.

Values of the factor σ are plotted in Fig. 112 in terms of the ratio $\frac{b_s}{\delta} = \frac{\text{slot opening}}{\text{clearance}}$.

The fringing field at the pole tips is equivalent to an increase in the value of b , but this effect is generally offset by the increased gap space at the tips. Arnold has given a method¹ for computing the increased length of pole due to fringing, but it is generally unnecessary to introduce such refined calculations.

84. Corrected Axial Length.—The reluctance due to the ventilating ducts may be considered as reducing the axial length l to

$$l'_1 = l \frac{t_v - \sigma b_v}{t_v} \tag{16}$$

where t_v is the distance between centers of the ventilating ducts and b_v is the width of the duct (Fig. 113), and where σ is to be found from Fig. 112 using as argument $\frac{b_v}{\delta}$. The length l'_1 can be further corrected to take account of the flux which enters the sides of the core from the flanks of the pole shoes, as indicated by the dotted lines in Fig. 113; the correction takes the form of an additional length, l'_2 , so that the equivalent axial length is

$$l' = l'_1 + l'_2 \tag{17}$$

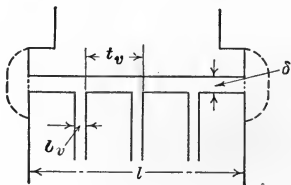

FIG. 113.

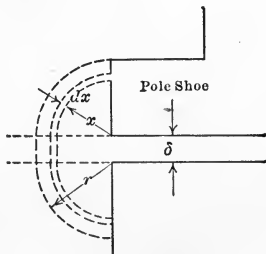

FIG. 114.

FIGS. 113 and 114.—Correction of axial length due to fringing of flux.

The value of l'_2 may be estimated as follows: Assume that the lines of force of the fringing flux are made up of quadrants of circles and of straight lines, as in Fig. 114. The permeance of an elementary tube of width dx and breadth b' is

$$dP = \frac{b'dx}{\delta + \pi x}$$

¹ Die Gleichstrommaschine, Vol. I, p. 274, 2nd ed.

and the entire permeance of all the tubes between the limits $x = 0$ and $x = r$, on both sides of the core, is

$$P = 2 \int_0^r \frac{b' dx}{\delta + \pi x} = \frac{2}{\pi} b' \log_e \frac{\delta + \pi r}{\delta}$$

But the permeance is to be made equivalent to that of a tube of force of length δ and cross-section $b'l'_2$, hence

$$\frac{b'l'_2}{\delta} = \frac{2}{\pi} b' \log_e \left(1 + \frac{\pi r}{\delta} \right)$$

and

$$l'_2 = 1.5\delta \log_{10} \left(1 + \frac{\pi r}{\delta} \right) \quad (18)$$

For values of r from 1 to 5 times δ , l'_2 varies from 0.9δ to 1.8δ . Generally it is sufficiently accurate to take $l'_2 = 1.5\delta$.

Having found b' and l' , the corrected value of flux density in the air-gap is

$$B_g = \frac{\Phi}{b'l'}$$

and therefore

$$AT_g = 0.8B_g\delta$$

if metric units are used (flux density in lines per sq. cm. and air-gap in centimeters), or

$$AT_g = 0.3133 B''_g\delta''$$

if flux density is given in lines per sq. in. (B''_g) and air-gap in inches (δ'').

85. Ampere-turns Required for the Teeth.—The same difference of magnetic potential that maintains the flux through the teeth also produces a certain amount of flux through the slots, since the two paths are in parallel. When the teeth are not highly saturated their permeance is so considerable that the flux passing down the slots is relatively insignificant and may be neglected; but in many machines the iron of the teeth is purposely worked at high flux density in order to limit the effect of armature reaction (see Chap. V), and in such cases the permeance of the teeth is decreased to such an extent that the slot permeance becomes comparable with it. If, then, it were assumed that the entire flux per pole passed through the teeth

immediately under the pole (with an allowance for the spread of the flux at the pole tips), the resultant tooth density would be higher than it is in reality, and the ampere-turns per unit length corresponding to this apparent density might be greatly in excess of the true value because of the flatness of the magnetization curve at high saturation. The actual tooth density, B_t , must therefore be distinguished from the apparent density, B'_t .

The conditions that determine the relation of the actual to the apparent density are (1) that the total flux per pole is equal to the sum of the flux in the iron of the teeth and in the air of the slots, ventilating ducts, and insulation space between laminae; and (2) that the magnitudes of the flux in the iron and in the air are proportional to the permeances of the respective paths. Therefore

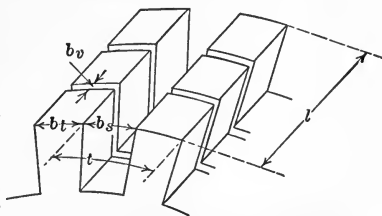

FIG. 115.—Dimensions of teeth and slots.

$$\Phi = \Phi_{iron} + \Phi_{air} \quad (19)$$

$$\frac{\Phi_{iron}}{\Phi_{air}} = \frac{\mu \times \text{cross-section of iron}}{\text{cross-section of air}} = \mu K \quad (20)$$

where μ is the permeability of the iron corresponding to the actual tooth density B_t .

Referring to Fig. 115,

$$\text{cross-section of iron} = b_t(l - n_v b_v)k \quad (21)$$

where k is the lamination factor (usually about 0.9), and

$$\text{cross-section of air} = b_s l + b_t n_v b_v + b_t(l - n_v b_v)(1 - k) \quad (22)$$

From equations (21) and (22) K may be determined for a given set of dimensions. It follows that

$$\frac{\Phi}{\Phi_{iron}} = \frac{\Phi_{iron} + \Phi_{air}}{\Phi_{iron}} = \frac{1 + \mu K}{\mu K} = \frac{B'_t}{B_t} \quad (23)$$

For a given value of K it is possible to compute from this equation a series of simultaneous values of B_t and B'_t by assuming values for B_t , finding the corresponding values of μ from the magnetization curve of the core material, and substituting in equation (23). Thus, in Fig. 116, curve M shows the relation between B_t and at_t , as determined by test, for commercial sheet steel. The remaining

curves give B'_t for various values of K . Thus QR is the value of B_t corresponding to $B'_t = PR$, when $K = 0.5$.

The above method of determining B_t when B'_t is known has the disadvantage that K may differ from any of the values for which curves have been prepared, and the labor of preparing such curves as those of Fig. 116 is in itself very tedious. It is

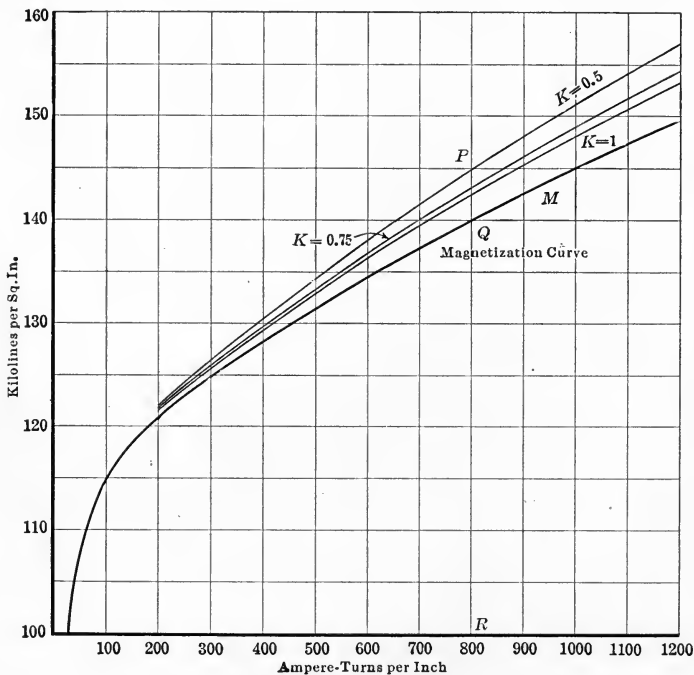

FIG. 116.

possible to find B_t from B'_t , for any value of K , directly from the magnetization curve (M , Fig. 116), as follows:

From the relation

$$\frac{B'_t}{B_t} = \frac{1 + \mu K}{\mu K}$$

we have

$$B'_t = B_t + \frac{1}{K} \frac{B_t}{\mu} = B_t + \frac{H}{K} \quad (24)$$

provided B is expressed in lines per sq. cm.

In Fig. 117, let C represent the magnetization curve plotted in terms of B and H , and assume for the present that B and H are plotted to the same scale. To the left of the origin lay off any convenient scale to represent values of K , and lay off ON equal to unity to the scale of K . Then, if OM is any value of K , $\frac{ON}{OM} = \frac{1}{K} = \tan \alpha$, and if OR is drawn parallel to MN the

intercept QR will equal $\frac{H}{K}$, corresponding to $H = OQ$. Therefore, $PR = OS = B'_t$ since $PQ = B_t$. That is, for a given value of B'_t , lay off OS on the axis of ordinates equal to this given value and through S draw a line parallel to MN until it intersects curve C in a point P . Ordinate PQ is then the actual tooth density (B_t) and OQ is the corresponding value of H .

Since B and H are never plotted to the same scale, and since magnetization curves are usually drawn in terms of B and at , suitable modifications must be made in the construction. If B is plotted to represent lines per sq. cm. and at in am-

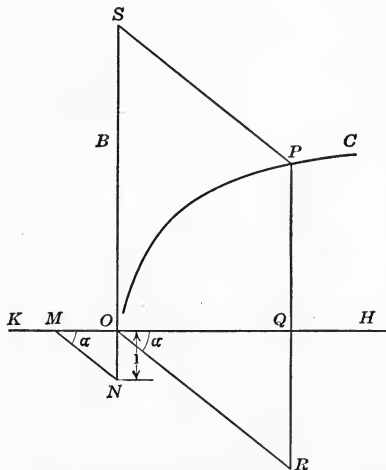

FIG. 117.—Graphical relation between apparent and actual tooth induction.

per-turns per cm., the length ON must be made equal to $\frac{4\pi A_0}{10B_0}$ to the scale of K , where

A_0 = number of ampere-turns per cm. per unit length of horizontal axis

B_0 = number of gausses per unit length of vertical axis.

If B is in lines per sq. in. and at in ampere-turns per in., ON must be made equal to $2.54 \times \frac{4\pi A'_0}{10 B'_0} = 3.19 \frac{A'_0}{B'_0}$ to the scale of K , where

A'_0 = number of ampere-turns per inch per unit length of horizontal axis

B'_0 = number of lines per sq. in. per unit length of vertical axis.

Otherwise the construction is the same as before.

It does not immediately follow that $AT_t = at_t \cdot l_t$, because the tapering of the teeth results in an increasing density from the tip

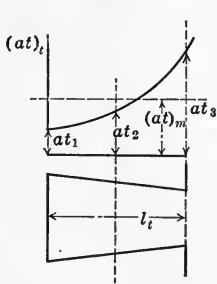

FIG. 118.—Variation of excitation along tooth axis.

to the root, consequently at_t changes in value from point to point along the length of the tooth; nor does it follow that the value of at to be used is that corresponding to the flux density at the middle of the tooth. If values of B_t are computed for a number of points along the length of the tooth, and the corresponding values of at_t , found from Fig. 116, are plotted, a curve like Fig. 118 will in general result. Evidently the true value of at_t is the mean ordinate of the curve; assuming that the curve is parabolic, the mean ordinate, by Simpson's rule, is

$$(at_t)_{mean} = \frac{at_1 + 4at_2 + at_3}{6} \tag{25}$$

whence

$$AT_t = (at_t)_{mean} \cdot l_t \tag{26}$$

86. Ampere-turns Required for the Armature Core.—It is clear from Figs. 101 and 102 that the iron of the core below the roots of the teeth carries half of the useful flux per pole.

Therefore,

$$B_a = \frac{\Phi}{2A_a} \tag{27}$$

If the radial depth of the iron under the teeth is h ,

$$A_a = kh(l - n_v b_v) \tag{28}$$

To the value of B_a thus determined there corresponds a value of at_a ampere-turns per unit length, whence

$$AT_a = at_a \cdot l_a \tag{29}$$

87. Ampere-turns Required for the Pole Cores and Pole Shoes.—The flux carried by the pole cores and pole shoes varies from section to section, being greatest near the yokes and gradually decreasing toward the gap as more and more of the leakage

flux is shunted off; but it may be assumed without sensible error that the flux is uniform and equal to $\nu\Phi$. We have then,

$$B_c = \frac{\nu\Phi}{A_c} \text{ and } B_s = \frac{\nu\Phi}{A_s} \quad (30)$$

to which values of flux density there correspond unit excitations of at_c and at_s , respectively; hence

$$AT_c = at_c \cdot l_c \text{ and } AT_s = at_s \cdot l_s \quad (31)$$

88. Ampere-turns Required for the Yoke.—The flux carried by the yoke is either equal to $\nu\Phi$ or $\frac{1}{2}\nu\Phi$, depending upon the type of machine. Fig. 101 illustrates the first case, and Fig. 102 the second case; the latter is representative of most modern machines. Then, usually,

$$B_y = \frac{\frac{1}{2}\nu\Phi}{A_y} \quad (32)$$

to which value there corresponds at_y ampere-turns per unit length, and

$$AT_y = at_y \cdot l_y \quad (33)$$

89. The Coefficient of Dispersion.—The leakage flux φ that enters into the equation

$$\nu = 1 + \frac{\varphi}{\Phi}$$

includes the flux in all paths associated with the main flux Φ and originating in the exciting winding, but which do not close through the armature. If the leakage paths are correctly mapped out, the stray flux in each of them is equal to the m.m.f. divided by the reluctance. The calculation can be simplified, and a fair degree of accuracy attained, by assigning simple geometrical forms to the leakage paths. Since the greater part of the leakage flux takes place through air, the reluctance of the path in the iron may be neglected. It must be remembered also that all of the leakage paths are not acted upon by the same difference of magnetic potential. For instance, the m.m.f. acting between the tips of adjacent poles is that required to drive the useful flux across the double air-gap, two sets of teeth, and the armature, or it is equivalent to

$$X = AT_a + 2AT_\theta + 2AT_t \text{ ampere-turns; } \quad (34)$$

then points on adjacent pole cores that are each half way between the yoke and the shoe will have between them a difference of magnetic potential approximately equivalent to $\frac{1}{2}X$ ampere-turns.

Let Fig. 119 represent a development of a portion of a multipolar machine. The leakage flux in any one pole P is represented by the dashed lines ϕ_1, ϕ_2 , etc., and the total leakage flux per pole is

$$\phi = 2\phi_1 + 4\phi_2 + 2\phi_3 + 4\phi_4 \tag{35}$$

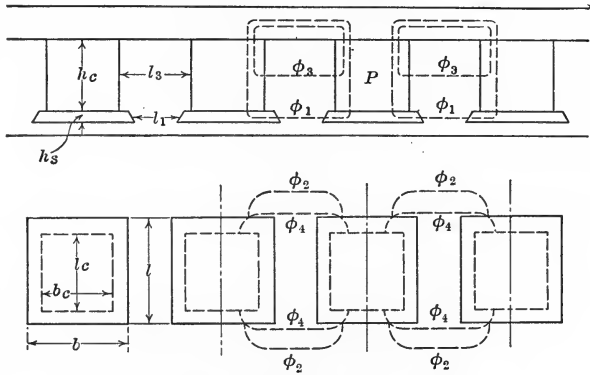

FIG. 119.—Paths of leakage flux.

Leakage between Inner Surface of Pole Shoes, ϕ_1 .—

$$\begin{aligned} \phi_1 &= \frac{4\pi}{10} X \frac{h_s l}{l_1} \text{ (lengths expressed in centimeters)} \\ \text{or} \quad \phi_1 &= 3.2X \frac{h_s l}{l_1} \text{ (lengths expressed in inches)} \end{aligned} \tag{36}$$

Leakage between Lateral Surfaces of Pole Shoes, ϕ_2 .— Assume that the lines of force are made up of straight lines of length l_1 , and of quadrants of circles of radius x .

$$\begin{aligned} \therefore \phi_2 &= \frac{4\pi}{10} X \int_0^{b/2} \frac{h_s dx}{l_1 + \pi x} = 0.4Xh_s \log_e \left(1 + \frac{\pi b}{2 l_1} \right) \\ &\text{(lengths expressed in centimeters)} \\ \text{or} \quad \phi_2 &= 2.34Xh_s \log_{10} \left(1 + \frac{1.57b}{l_1} \right) \\ &\text{(lengths expressed in inches)} \end{aligned} \tag{37}$$

Leakage between Inner Surfaces of Pole Cores, φ_3 .—

$$\left. \begin{aligned} \varphi_3 &= \frac{4\pi}{10} \frac{X}{2} \frac{h_c l_c}{l_3} \text{ (lengths expressed in centimeters)} \\ \text{or} \\ \varphi_3 &= 1.6X \frac{h_c l_c}{l_3} \text{ (lengths expressed in inches)} \end{aligned} \right\} (38).$$

If the pole cores are round, of diameter d_c , they may be assumed to have been replaced by a square pole of equal cross-section. In that case

$$b_c = l_c = \frac{d_c}{2} \sqrt{\pi} = 0.89d_c \quad (39)$$

The above expression for φ_3 is derived on the assumption that the axes of the pole cores are parallel. This is approximately the case when the machine has numerous poles. If the poles are considerably inclined to each other, let $(l_3)_{min}$ and $(l_3)_{max}$ represent their minimum and maximum separations, at the pole shoes and yoke, respectively; then it is readily shown that

$$\left. \begin{aligned} \varphi_3 &= \frac{4\pi}{10} X \frac{l_c h_c}{(l_3)_{max} - (l_3)_{min}} \left[\frac{(l_3)_{max}}{(l_3)_{max} - (l_3)_{min}} \log_e \frac{(l_3)_{max}}{(l_3)_{min}} - 1 \right] \\ &\quad \text{(lengths expressed in centimeters)} \\ \text{or} \\ \varphi_3 &= 3.2X \frac{l_c h_c}{(l_3)_{max} - (l_3)_{min}} \left[\frac{2.3(l_3)_{max}}{(l_3)_{max} - (l_3)_{min}} \log_{10} \frac{(l_3)_{max}}{(l_3)_{min}} - 1 \right] \\ &\quad \text{(lengths expressed in inches)} \end{aligned} \right\} (40)$$

*Leakage between Lateral Faces of Pole Cores, φ_4 .—*The leakage paths may be assumed to be made up of straight lines of length l_3 and of quadrants of circles. The average m.m.f. acting on each elementary tube of force is $\frac{1}{2}X$.

$$\left. \begin{aligned} \therefore \varphi_4 &= \frac{4\pi}{10} \frac{X}{2} l_c \int_0^{1/2 b_c} \frac{dx}{l_3 + \pi x} = 0.2X h_c \log_e \left(1 + \frac{\pi}{2} \frac{b_c}{l_3} \right) \\ &\quad \text{(lengths expressed in centimeters)} \\ \text{or} \\ \varphi_4 &= 1.17X h_c \log_{10} \left(1 + \frac{1.57 b_c}{l_3} \right) \\ &\quad \text{(lengths expressed in inches)} \end{aligned} \right\} (41)$$

The coefficient of dispersion is then

$$\begin{aligned} \nu &= 1 + \frac{\varphi}{\Phi} = 1 + \frac{2\varphi_1 + 4\varphi_2 + 2\varphi_3 + 4\varphi_4}{\Phi} \\ &= 1 + \frac{X}{\Phi} \cdot \text{(function of frame dimensions)} \end{aligned} \quad (42)$$

If the flux Φ were directly proportional to the excitation X , the coefficient ν would be constant; but since X includes the excitation required to drive the flux through the teeth, and these are frequently highly saturated, the ratio $\frac{X}{\Phi}$ is not constant, hence ν is more or less variable. It generally increases as the load on the machine increases.

PROBLEMS

1. The shunt-field winding of a 10-pole machine has 550 turns per pole and produces a flux of 9×10^6 lines per pole when the exciting current is 18 amp. Find the inductance of the shunt circuit and the energy stored in the magnetic field produced by a shunt-field current of 18 amp. Assume that there is no magnetic leakage.

2. Construct the magnetization curve of a 6-pole machine which has the following dimensions, assuming that the coefficient of dispersion is 1.17, and that the rated speed is 375 r.p.m.

ARMATURE (of sheet steel):

✓ External diameter of core.....	46 in.
✓ Gross length of core.....	12 in.
✓ No. of ventilating ducts.....	4
✓ Width of each duct.....	$\frac{3}{8}$ in.
✓ Radial depth of core below teeth.....	$6\frac{3}{4}$ in.
✓ No. of slots.....	150
✓ Width of slot.....	0.56 in.
✓ Depth of slot.....	1.80 in.

AIR-GAP (clearance)..... 0.375 in.

POLE CORES (cast steel):

✓ Ratio of pole arc to pole pitch.....	0.7
✓ Diameter of pole cores.....	12 in.
Radial length of core.....	13 in.

YOKE (cast steel):

Radial depth.....	4 in.
✓ Axial width.....	15.5 in.

ARMATURE WINDING:

Type.....	Simplex lap
Total number of conductors.....	900
Conductors per slot.....	6
No. of winding elements.....	450

COMMUTATOR:

Diameter.....	35 in.
---------------	--------

3. Compute the coefficient of dispersion of the machine specified in Problem 2.

CHAPTER V

ARMATURE REACTION

90. Magnetizing Action of Armature.—In the foregoing discussion of the behavior of a dynamo, it was tacitly assumed that the armature was currentless. Under this no-load condition the magnitude and distribution of the magnetic flux are dependent only upon the excitation due to the field winding and upon the shape and materials of the frame. But, under load conditions, the current in the armature conductors gives rise to an independent excitation which alters both the magnitude and distribution of the flux produced by the field winding alone. This magnetizing action of the armature is called *armature reaction*.

For the sake of simplicity, let us examine first the conditions in a bipolar machine. If the armature is currentless, the flux due to the field excitation will be symmetrically distributed in the manner illustrated in Fig. 120. The line *ab*, drawn through the center of the shaft at right angles to the polar axis, is the *geometrical neutral axis*; it is an axis of symmetry of the flux under no-load conditions. Armature conductors on opposite sides of the geometrical neutral axis will then be the seat of oppositely directed e.m.fs. If, under no-load conditions, the brush axis coincides with the geometrical neutral, the winding elements lying in the neutral axis will be short-circuited by the brushes at the moment when they are not cutting lines of force, hence the short-circuit is harmless.

If the field excitation is now removed and the armature is supplied with current from some external source, there will result a magnetic field whose distribution is approximately as shown in Fig. 121. Magnetic poles will be developed in the line of the brush axis. Most of the flux will be concentrated in the region covered by the pole shoes, since the reluctance there is much less than in the interpolar gap.

Under load conditions, the armature current and the field excitation exist simultaneously, and the resultant flux can then

be thought of as compounded of the two fields shown separately in Figs. 120 and 121, at least as a first approximation.¹ The form of the resultant field is shown in Fig. 122, which serves equally well for the cases of generator and motor action. It will be observed that in the case of the generator *the field is strengthened at the trailing tips, A and A', and weakened at the leading tips, B and B'*; whereas in the case of the motor the exact reverse is true. Moreover, the neutral axis (that in which the winding elements are not cutting lines of force) has been shifted to the

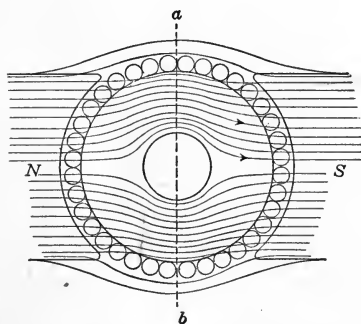

FIG. 120.—Distribution of magnetic field, armature currentless.

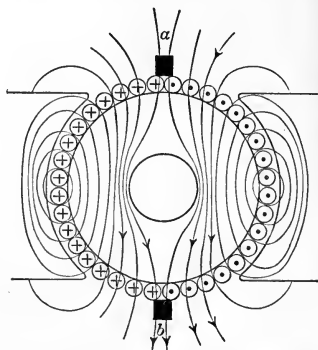

FIG. 121.—Magnetic field due to armature current, field magnets not excited.

position $a'b'$; the effect is the same as though the flux had been twisted or skewed in the direction of rotation in the case of the generator, and in the opposite direction in the case of the motor.

As a result of the shift of the neutral axis, the brushes (assumed to be still in the axis ab) short-circuit elements which are cutting lines of force and in which an active e.m.f. is being generated. Currents of large magnitude may therefore flow in such elements

¹ NOTE.—It is not exactly true that the resultant field is made up of the separate fields of Figs. 120 and 121 as components. What actually happens is that the windings of the field structure and of the armature each produce a definite m.m.f., and that these m.m.fs. then combine to form a resultant m.m.f., which in turn produces the resultant flux. The composition of the separate fields would give correct results only if the flux were at all points proportional to the m.m.f., and this condition is, of course, not satisfied in the presence of iron cores, especially if the iron is worked at a flux density at or near the knee of the magnetization curve. (See § 98.)

because of the low resistance of the circuit which includes the short-circuited winding elements and the brush contacts; and the rupture of this circuit, as the commutator segments pass from under the brush, will cause sparking and perhaps blistering of the commutator. Furthermore, the machine will not develop its full e.m.f.; for of the $Z/2$ conductors in series, say on the left-hand side of the armature of Fig. 122, those between b and b' will generate an e.m.f. opposite in sign to that of the e.m.f. due to conductors between b' and a . Both of these effects are

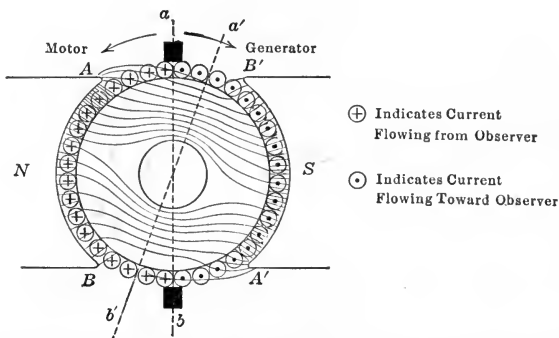

FIG. 122.—Distribution of magnetic field under load conditions.

objectionable, the former because it reduces the life of the commutator and lowers the efficiency, the latter because it unnecessarily reduces the available output of the machine. Obviously, the remedy for both troubles is to shift the brushes until they are in (or near) the neutral axis; but when the brushes are shifted, the armature field (Fig. 121) moves with them in such a way that the resultant polarization of the armature coincides with the brush axis.

The net result is that the resultant field tends to skew more and more as the brushes are moved toward the neutral axis. Fortunately, however, the piling up of the flux in the pole tips A and A' ultimately results in their saturation, so that further skewing becomes insignificant and the brush axis may even pass the neutral.

91. Commutation.—It is desirable at this point to examine the phenomena occurring during commutation somewhat more in

detail than has yet been done, in order to settle in a general way the conditions that must be satisfied by the brush position. Fig. 123 represents three elements, a , b and c , of a ring winding operating as a generator. It is evident that element a will occupy successively the positions of b and c , and that during the b position its current must change from the value existing in conductors to the left of the brush, to the equal and opposite value existing in conductors on the right. This change cannot occur instantaneously; in the ideal case the current would change uniformly from the initial to the final value in exactly the time required for the element to pass under the brush, during which time the element

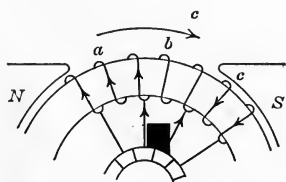

FIG. 123.—Reversal of armature current during commutation.

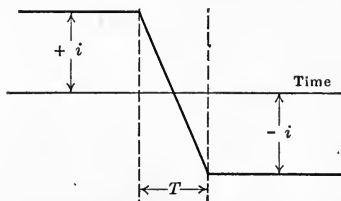

FIG. 124.—Ideal variation of current in coil undergoing commutation.

is short-circuited in the manner of coil b . This is represented diagrammatically in Fig. 124, where $+i$ and $-i$ are, respectively, the initial and final values of the current in the element, and T is the duration of the short-circuit, or the period of commutation.

Now, the self-inductance of the element undergoing commutation tends to keep the current at its original value and in the original direction, and in order to counteract this tendency, the e.m.f. of self-induction must be balanced by an opposing e.m.f. If, then, the brushes were exactly in the neutral axis, no e.m.f. would be generated in the short-circuited coil, the effect of self-induction would not be opposed, and the reversal of the current could not be completed in the time T . Since the direction of the e.m.f. required to cancel the e.m.f. of self-induction must be the same as the final direction of the current (see coil c , Fig. 123), it follows that the *short-circuited coil must be under the influence of the pole in advance of the neutral axis, in the direction of rotation.*

The position of the axis of commutation, with respect to the neutral axis, is shown in Fig. 125 for both generator and motor. It is seen from this figure that the brush displacement, α_m , of a motor is slightly less than the displacement, α_g , of an identical generator. When the angular displacement of the brushes is in the direction of rotation, as in a generator, the angle is called the angle of *brush lead*; when in the direction opposite to the rotation, as in a motor, it is called the angle of *backward lead*.

92. Components of Armature Reaction.—Imagine the brushes of the armature of Fig. 121 supplied with constant current from some external source, the field being unexcited. If the brushes are rocked forward or backward, the armature m.m.f. will follow, and it will remain constant in magnitude. It may,

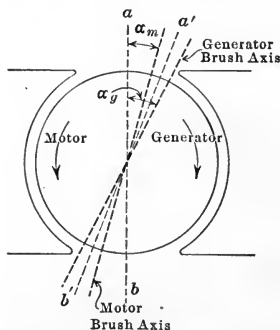

FIG. 125.—Axis of commutation in generators and motors.

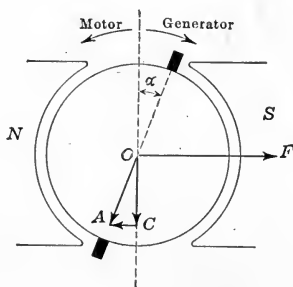

FIG. 126.—Components of armature M.M.F.

therefore, be represented by a line of constant length, OA , Fig. 126, in line with the brushes. If the fields are now excited, their magnetomotive force may be represented by a line OF (the direction of current flow in armature and field windings being taken the same as in Fig. 122). Resolving OA into the components OC and CA , it is seen that the armature magnetizing action is equivalent to a *cross-magnetization* due to OC (so called because it acts across the main m.m.f. OF), and a *demagnetization* due to CA , which directly opposes the main excitation, OF . The demagnetizing action of the armature is a direct consequence of the rocking of the brushes to the position most favorable for commutation.

It will be clear from Fig. 126 that if the brushes of a generator have a backward lead, the armature will assist in magnetizing the field, that is, the demagnetizing component becomes magnetizing. Similarly if the brushes of a motor are given a forward lead; but in both cases the commutator will spark viciously.

Were it not for the fact that a negative brush lead affects commutation unfavorably, the armature reaction might be purposely exaggerated to such an extent as to self-excite the fields. This feature is taken advantage of in the Rosenberg type of generator for train lighting (see Chap. XI), but in general it requires special auxiliary devices to take care of the commutation difficulties.

93. Cross-magnetizing and Demagnetizing Ampere-turns.—

The resolution of the armature m.m.f., OA , in Fig. 126, into components is not a strictly accurate proceeding; it is qualitative rather than quantitative. But it leads directly to the conclusion that the entire armature winding of Fig. 127 may be considered as made up of two distinct "belts" of conductors, namely, those between AD and CB , and those between CA and BD . The former conductors, when grouped in pairs in the manner indicated by the horizontal lines, constitute a number of turns whose

FIG. 127.—Cross-magnetizing and demagnetizing belts of conductors.

magnetizing effect is directly across that of the main exciting winding; they are called the *cross-magnetizing turns*. The remaining conductors, grouped in vertical pairs, constitute the *demagnetizing turns*, since their effect is in direct opposition to the main exciting winding. It follows, therefore, that in a *bipolar* machine the demagnetizing turns per pair of poles are equal to the number of armature conductors within the double angle of lead, 2α ; and the *demagnetizing* (or back) *ampere-turns* per pair of poles, AT_d , equal this number multiplied by the current per conductor.

$$\therefore AT_d = \frac{2\alpha Z}{360} \frac{i_a}{2} = \frac{\alpha Z i_a}{360} \quad (1)$$

Similarly, the *cross-magnetizing ampere-turns* are given by

$$AT_c = \frac{\beta'Z}{360} \cdot \frac{i_a}{2} = \frac{\beta'Zi_a}{720} \quad (2)$$

where

$$\beta' = 180 - 2\alpha$$

It is important to realize that the demagnetizing turns are a consequence of the cross-magnetizing action of the armature; for if the brushes are originally in the geometrical neutral axis, the entire magnetizing action of the armature is across the main field, thereby causing a distorted resultant field. The shifting of the brushes to a position near the resultant neutral axis then brings the demagnetizing turns into existence.

94. Cross-magnetizing and Demagnetizing Effect in Multipolar Machines.—In the foregoing discussion of the case of bipolar machines, a ring-wound armature was tacitly assumed.

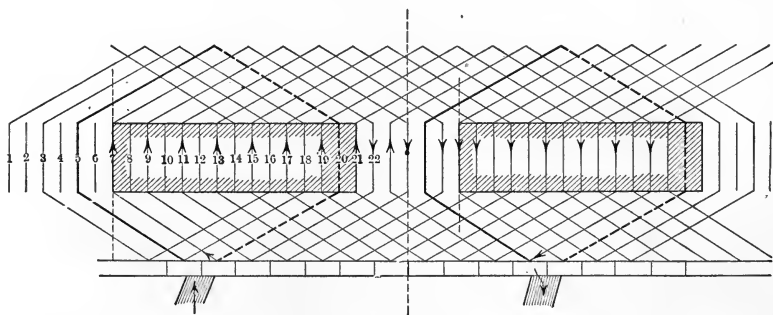

FIG. 128.—Reduction of demagnetizing action caused by fractional pitch of winding.

Accordingly, the brush axis and the axis of commutation coincided, and no distinction was made between them. It must be remembered, however, that the end connections of lap and wave windings are generally so shaped that the brushes are opposite the middle of the poles when the sides of the coil undergoing commutation are in the geometrical neutral.

An extension of the principles developed for the case of the bipolar machine leads to the generalization that all of the conductors lying within the double angle of lead have a demagnetizing

effect upon the field, while the remaining conductors produce a cross-magnetization. This conclusion holds accurately for all windings of the ring type, and for lap and wave windings of full pitch. But in short-chord windings it will be found that the conductors occupying the space between pole tips carry currents which are partly in one direction and partly in the other, thereby partially neutralizing the demagnetizing effect. For example, assume a 4-pole simplex lap winding having 80 conductors; that is

$$p = 4$$

$$a = 4$$

$$Z = 80$$

$$m = 1$$

Take $y_1 = 15$ and $y_2 = -13$. On tracing through the winding diagram, a portion of which is shown in Fig. 128, it will be found that the current in the interpolar region is alternately in opposite directions.

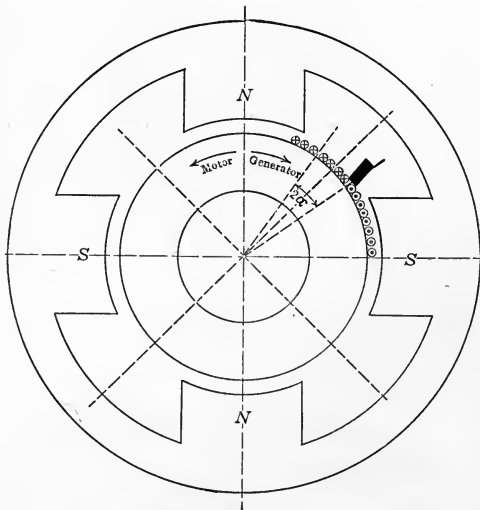

FIG. 129.—Demagnetizing belt of conductors in multipolar machine.

Omitting from consideration the special case of short-chord windings, the number of demagnetizing ampere-turns per pair of poles can be determined as follows (see Fig. 129):

The total number of conductors lying within the demagnetizing belts is

$$\frac{Z}{360} \cdot 2\alpha \cdot p$$

and, therefore, the number of demagnetizing ampere-turns per pair of poles is

$$AT_d = \frac{1}{2} \cdot \frac{Z}{360} \cdot \frac{2\alpha p}{p/2} \cdot \frac{i_a}{a} = \frac{\alpha Z i_a}{180a} \quad (3)$$

The cross-magnetizing ampere-turns produce distortion of the main field by strengthening the field at one tip of the pole and weakening it at the other, as in Fig. 130. But though all of the

conductors outside of the double angle of lead contribute to this effect, those which are not in the angle β subtended by the pole exert their m.m.f. upon a path so largely in air that the flux due to them is negligible; attention may,

therefore, be confined to the $\frac{\beta Z}{360}$ conductors under the pole. The m.m.f. due to these conductors is $\frac{4\pi}{10} \cdot \frac{\beta Z}{360} \cdot \frac{i_a}{a}$ gilberts, and this acts upon a path C whose reluctance is mainly due to the double air-gap and two sets of teeth; the teeth consume a m.m.f. equal to

$\frac{4\pi}{10} (2AT_t)$ gilberts, hence the remainder, or $\frac{4\pi}{10} \left[\frac{\beta Z}{360} \frac{i_a}{a} - 2AT_t \right]$, will produce a cross-field whose intensity at the tips is

$$B_c = \frac{4\pi}{10} \left[\frac{\beta Z}{360} \frac{i_a}{a} - 2AT_t \right] \frac{1}{2\delta'} \quad (4)$$

where $\delta' = \delta \frac{t}{t - \sigma b_s}$ is equal to the gap length corrected to take account of the effect of the slots.

The resultant pole tip densities will then be

$$(B_g - B_c) \text{ at the } \left\{ \begin{array}{l} \text{leading} \\ \text{trailing} \end{array} \right\} \text{ pole tip of a } \left\{ \begin{array}{l} \text{generator} \\ \text{motor} \end{array} \right\},$$

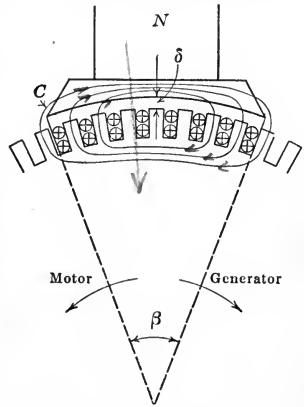

FIG. 130.—Cross field in multipolar machine.

and

$(B_g + B_c)$ at the $\left\{ \begin{array}{l} \text{trailing} \\ \text{leading} \end{array} \right\}$ pole tip of a $\left\{ \begin{array}{l} \text{generator} \\ \text{motor} \end{array} \right\}$.

Now, since commutation takes place at the weakened pole tip, and since the direction of the "commutating field" must be that of the original field, B_g , it follows that $B_c < B_g$, in order to generate in the short-circuited coil an e.m.f. of the proper direction to balance the e.m.f. of self-induction. Generally,

$$B_g - B_c = 2000 \text{ to } 3000 \text{ (lines per sq. cm.)}$$

and since B_g is usually between 6000 and 10,000, it follows that

$$B_g = (1.25 \text{ to } 2)B_c$$

Substituting this relation in the expression for B_c , and transposing

$$\delta' = \frac{(1.25 \text{ to } 2) \left[\frac{\beta Z i_a}{360a} - 2AT_t \right]}{1.6 B_g} \quad (5)$$

from which it is possible to compute the length of air-gap necessary to prevent reversal of the field at the commutating tip. If the clearance, δ , has been fixed, the formula gives an idea of the extent of chamfer to be given to the pole tips.

The above formula also leads to a relation which serves as an approximate criterion for a successful machine. Thus, neglecting the term AT_t , we may write

$$(1.25 \text{ to } 2) \frac{\beta Z i_a}{360a} = 1.6 B_g \delta' = 2AT_g \quad (6)$$

or

$$\frac{\beta Z i_a}{360a} = (1.0 \text{ to } 1.6)AT_g \quad (7)$$

Now, $\beta = \frac{360\Psi}{p}$ where Ψ , the ratio of pole arc to pole pitch, is usually about 0.7 in direct-current machines; and $\frac{Z}{2} \cdot \frac{i_a}{a}$ is the total number of armature ampere-turns. Further, AT_g will vary from 0.7 to 0.9 of the ampere-turns per pole. Substituting these relations, it will be found that

Armature ampere-turns per pole $\bar{\approx}$ 1.1 field ampere-turns per pole (8)

The factor 1.1 is an upper limit that is seldom found in practice; ordinarily it will have a value of from 0.8 to 0.9.

95. Corrected Expression for Demagnetizing Effect of Back Ampere-turns.—(a) *Lap Windings.*—Fig. 131 is a development of that portion of a “chorded” (short-chord) lap winding embraced in a span slightly greater than the pole-pitch. It is required to determine the reduction in the value of $AT_a = \frac{\alpha Z i_a}{180 a}$ due to the fact that the coils in the neutral zone carry currents which are not all in the same direction.

In the first place, it will be evident that if the winding were of full-pitch, all of the $\frac{2S}{p}$ coil sides lying to the left of A_2 would carry current in the same direction (vertically upward in the figure).

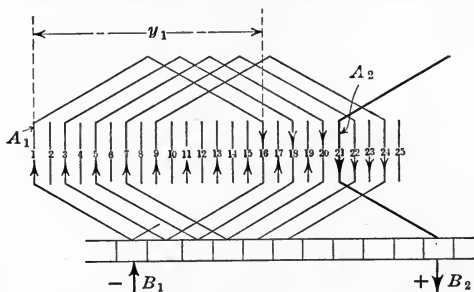

FIG. 131.—Fractional pitch lap winding.

In the second place, however short the chording may be, the current in the coil sides immediately to the right¹ of, and including, A_2 will all be in the same direction, or downward in the figure. It follows, therefore, that the reversed currents all lie in a zone to the left of A_2 , the extent of this zone depending upon the difference between y_1 and the pole pitch. Similarly, there will be zones of reversed currents to the left of all the coil edges, which, like A_1 and A_2 , are connected to commutator segments touched by the brushes.

If coil edge A_1 is numbered 1, the first coil edge carrying reversed current is $(y_1 + 1)$, the second is $(y_1 + 3)$, etc. The number corresponding to the last one in the group will evidently be $\frac{2S}{p} = y_1 + \left(\frac{2S}{p} - y_1\right)$.

¹ This is a consequence of the fact that the winding sketched in Fig. 131 is right-handed, *i.e.*, $y_1 > y_2$. If the winding were left-handed, $y_1 < y_2$, the words “right” and “left” would have to be interchanged.

Summarizing these results,

$y_1 + 1$	corresponds to the 1st
$y_1 + 3$	corresponds to the 2nd
$y_1 + 5$	corresponds to the 3rd
$y_1 + (2k - 1)$	corresponds to the k th
$y_1 + \left(\frac{2S}{p} - y_1\right)$	corresponds to the n th

In other words, there are n of such reversed bundles, where

$$2n - 1 = \frac{2S}{p} - y_1$$

or

$$n = \frac{1}{2} \left(\frac{2S}{p} - y_1 + 1 \right) \quad (9)$$

Since the current in each of these n coil edges balances the demagnetizing effect of the current in n bundles whose direction is normal, the total reduction will be that due to $2n$ bundles. Since each element contains $\frac{Z}{2S}$ turns, AT_d will be less than the computed value by

$$\frac{Z}{2S} \frac{i_a}{a} \left(\frac{2S}{p} - y_1 + 1 \right) \text{ ampere-turns} \quad (10)$$

It should be noted that extreme chording may cause some of the n reversed coil sides to fall outside of the double angle of lead, and, therefore vitiate the above correction. But such extreme chording would not be used in practice, hence the correction may be safely used. It should be noted, further, that neither the formula for AT_d nor for the correction due to chording takes account of the number of coil edges in the neutral zone which are short-circuited by the brushes during commutation.

(b) *Wave Windings*.—(Fig. 132). If y_1 is the back pitch of the winding (at the pulley end), and y_2 is the front pitch (at the commutator end),

$$y = \frac{y_1 + y_2}{2} = \frac{2S + a}{p}$$

the positive sign of a indicating that the winding is right-handed. The extent to which y_1 falls short of the pole pitch is then a measure of the chording; obviously, then, $y_2 > y_1$. Full-pitch winding would result in uniform opposition of direction of current on

either side of coil sides like A_1, A_2 , Fig. 132, which are in contact with the brushes.

Due to chording, however, the first conductor which carries reversed current is $(y_1 + 1)$, the second is $(y_1 + 3)$, etc. If there are n such conductors, the number of the n th conductor will be $y_1 + (2n - 1)$. All of these conductors bear even numbers,

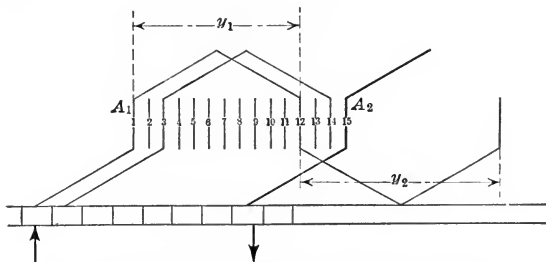

FIG. 132.—Fractional pitch wave winding.

since y_1 is necessarily odd. Now, the number of conductors (coil sides) per pole pitch is $\frac{2S}{p} = y - \frac{a}{p}$, which is a mixed number, but which may be taken as equal to y . If y is odd, the last even number in the group is $y - 1$, whence

$$y - 1 = y_1 + (2n - 1)$$

or

$$2n = \frac{y_2 - y_1}{2} \tag{11}$$

if y is even,

$$\begin{aligned} y &= y_1 + (2n - 1) \\ 2n &= \frac{y_2 - y_1}{2} + 1 \end{aligned} \tag{12}$$

hence the number of ampere-turns to be deducted from (AT_d) is

$$\left. \begin{aligned} \frac{Z}{2S} \frac{i_a}{a} \left(\frac{y_2 - y_1}{2} \right) & \quad \text{if } y \text{ is odd,} \\ \frac{Z}{2S} \frac{i_a}{a} \left(\frac{y_2 - y_1}{2} + 1 \right) & \quad \text{if } y \text{ is even.} \end{aligned} \right\} \tag{13}$$

96. Shape of Magnetic Field Produced by Armature Current.—

The current in the armature conductors lying to one side of the commutated coil has a direction opposite to that of the current in the conductors on the other side. In other words, the current

is distributed around the periphery in a series of alternately directed bands or belts, equal in number to the number of poles. This is indicated in Fig. 133 which represents a development of a 4-pole generator. The peripheral distribution of m.m.f. due to the armature current will then be represented by the ordinates of the broken line. The m.m.f. is a maximum at the points where the current reverses, and it is zero at the points midway between

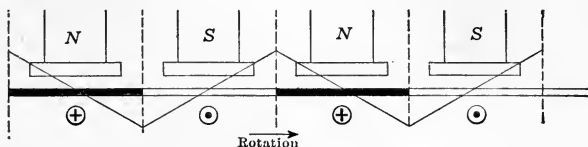

FIG. 133.—Peripheral distribution of armature m.m.f.

them. If the pole shoes completely surrounded the armature and the surface of the latter were smooth, the armature flux would be at all points directly proportional to the m.m.f., since in such a case the reluctance would be constant all around the gap (neglecting the reluctance of the flux paths in the iron in comparison with those in the air).

The number of conductors surrounded by the elementary tube of flux, P , Fig. 134, is $\frac{Z}{\pi d} \cdot 2x$ where d is the diameter of the arma-

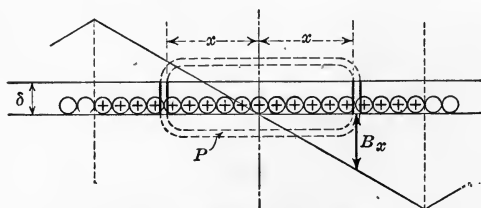

FIG. 134.—Calculation of armature flux.

ture. Since each conductor carries $\frac{i_a}{a}$ amperes, i_a being the total armature current, the m.m.f. acting on tube P is $\frac{4\pi}{10} \frac{Z}{\pi d} \frac{i_a}{a} \cdot 2x = \frac{4\pi}{10} q \cdot 2x$ where $q = \frac{Z}{\pi d} \cdot \frac{i_a}{a}$ is the number of *ampere-conductors*

per unit length of periphery. The flux density at a point distant x from the center of the pole is then

$$B_x = \frac{4\pi}{10} \frac{q \cdot 2x}{2\delta} = \frac{xq}{0.8\delta} \quad (14)$$

In the usual case of machines having pole shoes separated from each other by an intervening air-space, the flux distribution curve is not similar in form to the curve of m.m.f. Under the pole shoe it will closely follow the m.m.f. curve because of the practically uniform reluctance, but between the pole tips the reluctance increases at a much greater rate than the m.m.f., hence the armature flux density will be small at the point midway between them, as shown in Fig. 135.

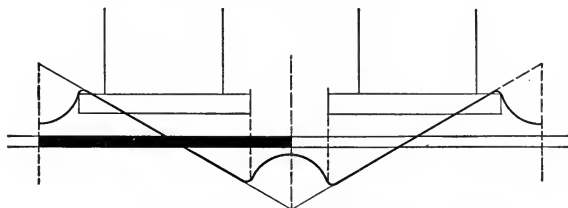

FIG. 135.—Distribution of armature flux.

97. Approximate Distribution of the Resultant Field.—Parts *a*, *b*, and *c* of Fig. 136 represent the effect of the armature field in modifying the magnitude and distribution of the resultant magnetic field for three positions of the brushes. In each diagram curve *F* shows the flux distribution due to the field excitation alone; curve *A* is the flux curve due to the armature, and curve *R* is the resultant of *F* and *A*. The diagrams are drawn for the cases of commutation:

- (a) midway between pole tips,
- (b) between the pole tips but nearer the leading tip,
- (c) under the middle of the poles.

In case (a) the distortion of the magnetic field is clearly shown. The symmetry of curve *A* with respect to *F* means that the flux added to the trailing tip (generator action being assumed) is exactly equal to the flux removed from the leading tip, hence the flux per pole remains unaltered. In case (b) there is distortion

and also a resultant demagnetization, as it is clear that the flux A under a pole is more subtractive than additive. In case (c) there is no distortion, but only demagnetization, as might be expected from the fact that the brushes have been shifted to such an extent as to eliminate all the cross ampere-turns and to raise the back ampere-turns to a maximum value.

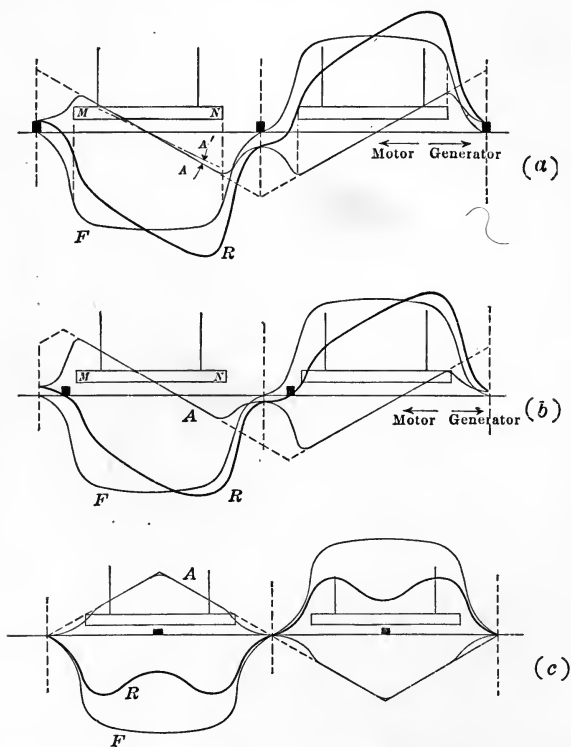

FIG. 136.—Distribution of resultant flux for various brush positions.

98. Demagnetizing Component of Cross Magnetization.—In the preceding article the shape of the resultant field R was determined on the theory that it may be considered as made up of two components: one, a field produced by the m.m.f. of the field winding acting alone; the other, a field produced by the armature m.m.f. acting alone. As a matter of fact, this theory is not strictly correct, as the following illustrative analogy will show:

Imagine a rod of cast iron acted upon simultaneously by compressive and tensile stresses, and suppose that these stresses are equal. If we assume that the stresses act independently in deforming the rod, the elongation due to the tension would considerably exceed the shortening due to the compression, provided the tensile stress is beyond the elastic limit; on this basis there would be a resultant elongation. But it is quite clear from the assumed equality of the stresses that the resultant stress and, therefore, the resultant deformation are both zero, hence the absurdity of the first method.

In the case of the magnetic circuit, m.m.f. is analogous to stress, and flux to deformation. Hence we must conclude that the only correct procedure is first to combine the several m.m.f.s. to form a single resultant, and from the latter determine the distribution and magnitude of the resultant flux.

It will be clear from the above considerations, taken in connection with diagrams *a* and *b* of Fig. 136, that the increased m.m.f. on the side *N* of the pole shoe cannot raise the resultant flux on that side to the same extent as the diminished m.m.f. at *M* lowers the flux on that side—this because of the fact that the permeability of the iron of the pole shoe and armature teeth decreases with increasing magnetizing force. Therefore, even when commutation takes place midway between the poles, corresponding to zero brush lead and an entire absence of back ampere-turns, there is still a resultant demagnetizing action due to the cross ampere-turns; though this effect is usually not very pronounced, it is nevertheless appreciable.

99. Excitation Required under Load Conditions.—Let curve *OM* of Fig. 137 represent the magnetization curve

of a generator, and let *OE*₀ be the terminal e.m.f. at rated load. The excitation required to generate this e.m.f. at no-load is then (*AT*)₀ ampere-turns per pair of poles. When the armature delivers current to the load, the excitation required to maintain

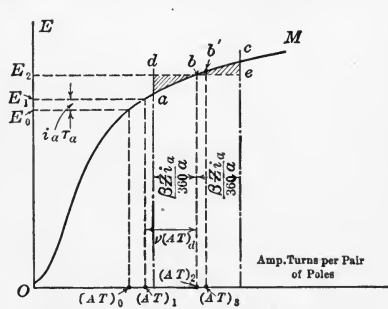

FIG. 137.—Excitation required under load conditions.

constant terminal e.m.f. must be greater than $(AT)_0$ in order to compensate:

(a) The ohmic drop, or drop in potential, caused by the flow of the current through the resistance of the armature.

(b) The demagnetizing effect of the armature back ampere-turns.

(c) The demagnetizing component of the armature cross ampere-turns.

(a) If the terminal e.m.f. under load conditions is to remain the same as at no load, the total *generated* e.m.f., E_1 , must be greater than E_0 by the drop $i_a r_a$, where r_a is the resistance of the armature. Referring to Fig. 137, the excitation required to generate E_1 volts is $(AT)_1$.

(b) If the armature demagnetizing ampere-turns per pair of poles (corrected, if necessary, to take care of chording) amount to $(AT)_d$, the field excitation must be increased over and above $(AT)_1$ by $\nu(AT)_d$, that is, to the value $(AT)_2$, corresponding to an open-circuit

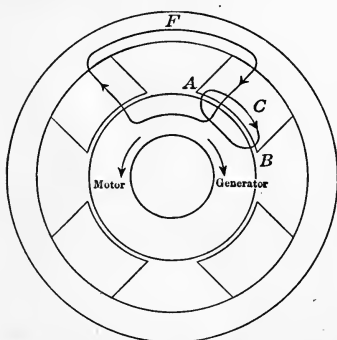

FIG. 138.—Comparison of paths of main and cross field.

e.m.f. of E_2 volts.

(c) It has been shown that the cross field is due to the conductors lying under a pole, and that the path of the cross field is as shown by the line marked C , Fig. 138. The number of cross ampere-turns acting upon this path is $\frac{\beta Z}{360} \cdot \frac{i_a}{a}$, half of which oppose the main excitation at pole tip A , the other half reinforcing it at B . These two excitations act on different magnetic paths, C and F , but it will be observed that the following parts are common to both paths: *the double air-gap, two sets of teeth, the armature core* (in part), and *the pole shoes*. The remaining parts of the two paths, namely, the pole cores and yoke in F , and the transverse path through the pole in C , constitute such relatively small percentages of the respective total reluctances that there is no appreciable error in assuming the two paths identical; and, there-

fore, that the two excitations may be combined to determine the resultant excitation, and therefore, also, the resultant flux. (It will be readily understood that two or more m.m.fs. cannot in general be combined to form a resultant unless they act upon one and the same magnetic circuit, just as forces cannot be combined to form a resultant force unless they act upon the same body.)

It follows from the fact that the magnetization curve M (Fig. 137) is drawn with abscissas equal to the ampere-turns per pair of poles that the weakening effect at the one pole tip, and the strengthening effect at the other, must be taken as due to $\frac{\beta Z i_a}{360 a}$ ampere-turns at each tip. In Fig. 137, therefore, this

number of ampere-turns is to be laid off to scale on either side of $(AT)_2$, whence the resultant diminution of the total flux per pole will be proportional to the excess of area abd over area bce . In order that the total flux may still have the magnitude which will yield the desired e.m.f., E_0 , the excitation must be increased to $(AT)_3$, the point b' on the curve OM being so selected that the following condition is satisfied (see Fig. 139):

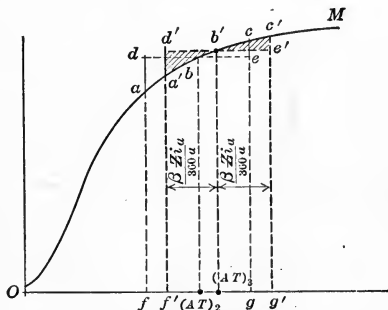

FIG. 139.—Excitation under load conditions.

$$\text{area } f'd'e'g' + \text{area } b'c'e' - \text{area } a'b'd' = \text{area } fdeg \quad (15)$$

The total flux will then be the same as though there were no demagnetizing effect due to the cross-magnetizing ampere-turns.

The demagnetizing effect of the cross-turns is obviously represented by the difference between $(AT)_3$ and $(AT)_2$.

The curve of resultant flux distribution in the air-gap (R , Fig. 136a) was obtained by assuming that the armature m.m.f. produced a flux distribution as represented by curve A , the ordinates of which were taken to be proportional to the m.m.f. except at the tips of the poles. A greater degree of accuracy in the construction of curve A is possible through the application of the theory involved in Fig. 140. Thus, let curve M , Fig. 140,

be the magnetization characteristic of the machine, and let C be that part of it required by the double air-gap, two sets of teeth, and the intervening portion of the armature core. When the flux per pole is $O\Phi$, curve abc will show the distribution of flux under the pole due to the armature cross magnetization for the reason that curve abc relates to that part of the magnetic circuit acted upon by the cross-turns. The straight part of curve A , Fig. 136a, should then be replaced by a curve similar in shape to abc of Fig. 140 (see curve A' , Fig. 136a).

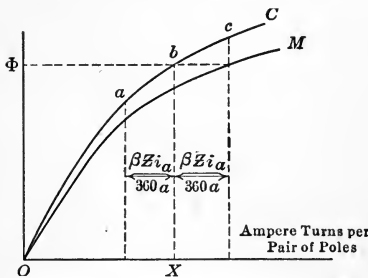

FIG. 140.—Determination of flux distribution due to armature m.m.f.

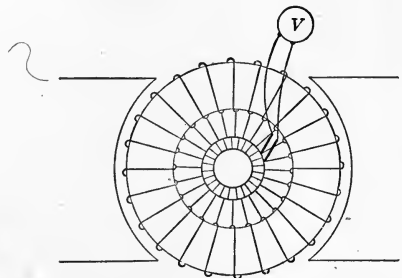

FIG. 141.—Double pilot brush.

100. Experimental Determination of Flux Distribution.—

Since the instantaneous e.m.f. generated in an armature conductor is proportional to the radial component of the flux density at the point occupied by the conductor at the moment in question (see Art. 32), the measurement of this e.m.f. will provide data for the calculation of the flux distribution.

Consider the case of a simplex ring-wound armature (Fig. 141) provided with such a large number of commutator segments that the turns of each element may be assumed to be concentrated in a radial plane, in other words, that all the turns of the element (if there be more than one turn per element) are simultaneously in a field of the same intensity. Take a narrow strip of tough paper (sheet fiber or press-board) whose length is equal to the periphery of the commutator, and along its axis drill a series of small holes whose spacing is the same as that of the commutator bars. Wrap the strip around the commutator and fasten it to the brush studs so that the commutator may rotate within it without binding. The free ends of a pair of leads connected to a low-

reading voltmeter are then to be provided with contact points made of moderately hard lead pencils. When the contact points are inserted into adjacent holes in the strip, the reading of the voltmeter will be equal to the e.m.f. generated in the element minus the ohmic (ir) drop due to the current flowing through the resistance of the element, assuming that the experiment is made when the machine is running under load conditions.

Instead of the perforated strip described above, there may be employed a "pilot" brush made of two thin pieces of sheet brass screwed on opposite sides of a strip of wood or ebonite, whose thickness is such that the metal strips are separated by the distance from center to center of adjacent commutator segments.

A similar arrangement will suffice in the case of a simplex lap or a simplex wave winding, provided the elements are of full pitch; moreover, in the case of the simplex wave winding, the voltmeter reading will be due to $p/2$ elements in series, instead of only one element. If the winding is duplex or triplex, the spacing of the contact points must be two or three segments, respectively; in general, if the winding is m -plex, the distance between contacts must correspond to m commutator segments.

As stated above, the observed readings of the voltmeter are less than the true values of generated e.m.f. by an amount equal to the ohmic drop in the element (or elements) due to load current if the machine is supplying an external circuit. In order to eliminate this correction of the observed readings, an auxiliary "search" coil, of full pitch, may be wound on the armature, one of its terminals being grounded on the shaft and the other connected to an insulated stud on the end of the shaft. Connect one terminal of a voltmeter of the D'Arsonval type to the frame of the machine (or better, to a metal brush rubbing on the shaft) and the other terminal to a brush that makes contact once per revolution with the insulated stud. If the moving coil of the voltmeter has sufficient inertia and is well damped, it will give a steady reading proportional to the e.m.f. generated in the search coil at the instant when the contact is established between the brush and the rotating stud. If the brush is made capable of adjustment around the arc of a circle concentric with the shaft, the contact can be made to occur when the search coil is in any desired position under the poles.

101. Potential Curve.—In Fig. 142 the ordinates e_1, e_2, e_3 , etc., represent the e.m.fs. generated in individual coils. It is evident, therefore, that the expression

$$e_1 + e_2 + e_3 + \dots + e_n$$

will be equal to the reading of a voltmeter one of whose terminals is connected to the main brush (B) and the other to a single

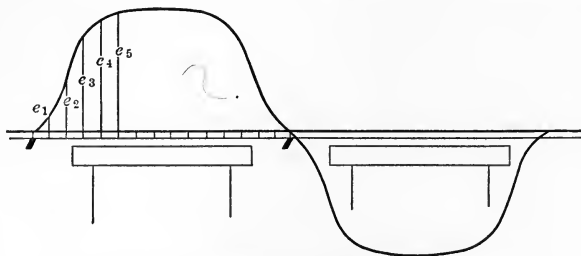

FIG. 142.—Variation of voltage per element.

pilot brush separated from B by an angle equivalent to the spread of n coils. If the pilot brush (P , Fig. 143) is moved around the periphery of the commutator and voltmeter readings (corrected for drop of potential if current is flowing) are taken at various points, a *potential curve* of the kind shown in full line in Fig. 144 will result.

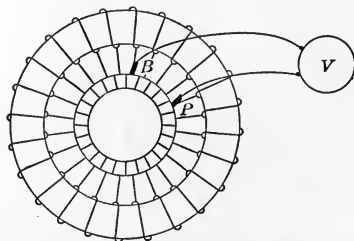

FIG. 143.—Determination of potential curve.

Since any ordinate, e , of this curve is the sum of the ordinates of the dotted curve (which is the same as that of Fig. 142) lying to the left of e , it follows that the first derivative of the function which represents the potential curve will represent the curve of flux distribution, provided the winding is divided into a large

number of elements. In other words, the slope of the potential curve at any point is proportional to the e.m.f. generated in the coil corresponding to that point.

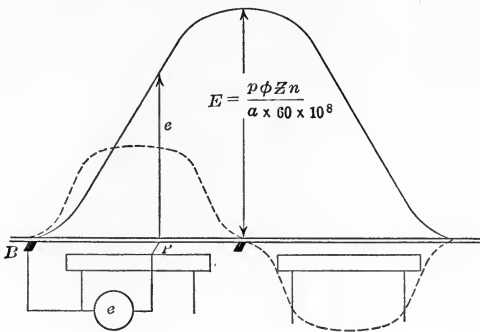

FIG. 144.—Relation between voltage per element and potential curve.

102. Predetermination of Flux Distribution in the Air-gap.—

The change in the distribution of the air-gap flux due to the magnetic reaction of the armature current is very important because of its effect upon the commutating characteristics of the machine, as explained in a preliminary manner in Art. 91 and in greater detail in Chap. VIII. It is therefore occasionally desirable, in designing a new machine, to be able to predetermine the curve of flux distribution due to the field excitation alone (curve *F*, Fig. 136), and also the curve of flux distribution due to the armature m.m.f. (*A*, Fig. 136). Several methods¹ for determining these curves have been developed, but all of them, except that of Carter, are approximate; and Carter's method, though mathematically correct, is derived by assuming a simple shape of pole core and pole face that is not ordinarily used in practice.

For determining the curve of field flux distribution, the method

¹ W. E. Goldsborough, Trans. A.I.E.E., Vol. XV, p. 515; Vol. XVI, p. 461; Vol. XVII, p. 679.

S. P. Thompson, "Dynamo Electric Machinery," Vol. II, p. 206, 7th ed.

F. W. Carter, Electrical World, Vol. XXXVIII, p. 884 (1901).

E. Arnold, "Die Gleichstrommaschine, Vol. I, p. 320, 2d ed.

T. Lehmann, Elektrotechnische Zeitschrift, Vol. XXX, pp. 996 and 1019 (1909).

B. G. Lamme, Trans. A.I.E.E., Vol. XXX, Part 3, p. 2362 (1911).

C. R. Moore, Trans. A.I.E.E., Vol. XXXI, Part I, p. 509 (1912).

recommended by Arnold involves mapping out the paths of the lines of force in the air-gap and in the interpolar spaces in the manner illustrated in Fig. 145. This leaves much to one's judgment, but some guidance is afforded by the consideration that the lines are substantially perpendicular to the surfaces of the pole faces and of the armature where they enter or leave the iron;

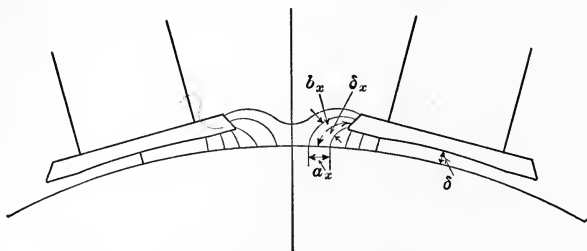

FIG. 145.—Distribution of main field.

it is also true that the flux will distribute itself in such a manner that the total reluctance is a minimum, or, what is the same thing, for a given m.m.f. between the pole face and armature surface, the total flux will be a maximum. If, then, more than one trial is made, that one will be most nearly correct which yields the largest total flux.

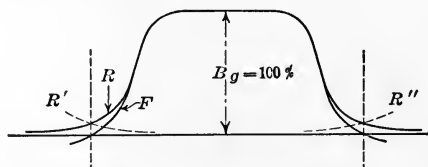

FIG. 146.—Curve of flux distribution.

Under the central part of the pole, where the air-gap (δ) is uniform, the flux density (B_g) will also be uniform and inversely proportional to δ ; at any other point a tube of force of length δ_x and mean section b_x (taking a unit length along the core) will have a permeance b_x/δ_x , hence the flux density at the armature surface will be

$$B_x = \frac{\text{m.m.f.}}{a_x} \cdot \frac{b_x}{\delta_x} = B_g \frac{\delta}{\delta_x} \cdot \frac{b_x}{a_x} \quad (16)$$

If B_g is taken as 100 per cent., values of B_x can then be found from

the scaled values of δ_x , b_x and a_x , and the computed results when plotted along the developed armature surface will determine a curve like R , Fig. 146. Curves R' and R'' represent portions of similar curves for adjoining poles (of opposite polarity), so that the resultant of R , R' and R'' gives the desired curve, F . The area

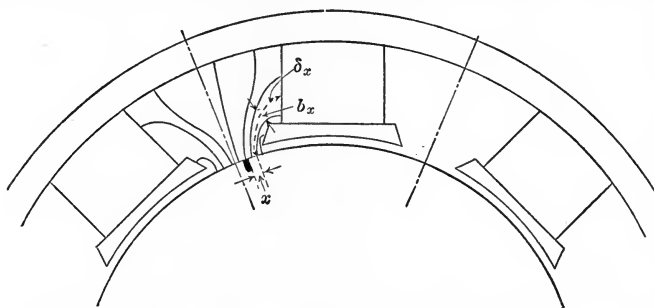

FIG. 147.—Magnetic lines of force due to armature current.

of one loop of curve F , multiplied by l' (the corrected length of armature core) must then equal Φ .

The determination of the curves of flux distribution due to the armature m.m.f. (curve A , Fig. 136) is more difficult than in the case of the field flux, but the same general method is applicable. Thus, in Fig. 147 are indicated the paths of the lines of force

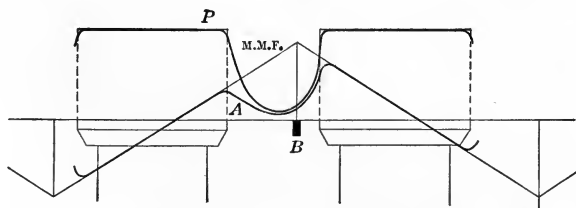

FIG. 148.—Calculation of flux distribution due to armature m.m.f.

emanating from the armature. At any distance x from the brush the permeance of the tube of force of unit depth parallel to the shaft will be equal to $\frac{b_x}{\delta_x}$, and if the peripheral distribution of permeance is plotted, as curve P of Fig. 148, and the ordinates of curve P are multiplied by the corresponding ordinates of the curve of armature m.m.f. (M.M.F.), the resultant values will give

the curve of armature flux (A). The field due to the armature m.m.f. has greatest influence in the axis of commutation, shown at B in the figure; in the paper by Lamme (*loc. cit.*) it is recommended that the mean path of the flux issuing from the axis of commutation be taken as the arc of a circle extending to the middle point of the pole core, and intersecting the surfaces of armature and pole core at right angles.

PROBLEMS

1. The machine specified in Problem 2, Chap. IV, has a brush lead of six commutator segments. How many ampere-turns per pole are necessary to compensate the demagnetizing action of the armature when the machine is delivering 600 amp.?

2. Compute the field intensity at the pole tips due to the cross-field of the armature of the machine referred to in Problem 1, when it is delivering 600 amp. Make the calculations on the assumption that the field excitation is sufficient to give an average air-gap density of 50,000 lines per sq. in.

3. Under the conditions assumed in Problem 2, what additional field excitation is necessary to compensate the demagnetizing component of cross-magnetizing action?

4. The armature resistance of the machine specified in Problem 2, Chap. IV, measured between brushes, is 0.016 ohm. When the machine is delivering an armature current of 600 amp., a voltmeter connected to a double pilot brush spanning adjacent commutator segments gives a reading of 10.67 volts. What is the field intensity in the region occupied by the winding element that is connected to the commutator segments touched by the pilot brushes?

CHAPTER VI

OPERATING CHARACTERISTICS OF GENERATORS

103. Service Requirements.—The lamps, motors, or other translating devices supplied with electrical energy from a distribution circuit may be connected to the supply mains in *parallel*, in *series*, or in *series-parallel*, as shown diagrammatically in Fig. 149*a*, *b*, and *c*.

Parallel connection (*a*) is used when the individual units constituting the load on the system are designed to operate with a constant difference of potential between their terminals, and in such a system any individual load unit can be disconnected

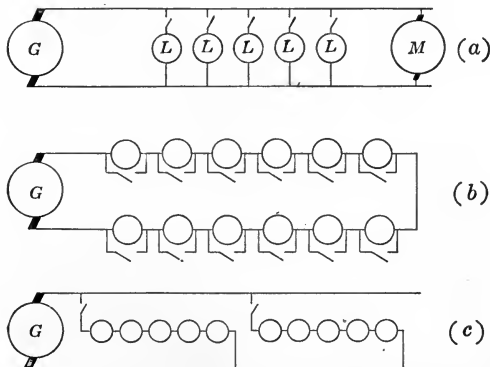

FIG. 149.—Parallel, series and series-parallel circuits.

without interfering with the operation of the remaining units; as examples of this class of service may be mentioned the use of incandescent lamps for interior lighting, and street railways operating with constant difference of potential between trolley and rail.

Series connection (*b*) is used principally in arc-lighting and in series-incandescent lighting of streets and alleys, where each lamp requires the same current. If an individual load unit in this system is to be cut out of service, it cannot be disconnected

as in the parallel system, but must be short-circuited by a "jumper" connection, as in Fig. 149*b* above, in order to preserve continuity of service in the remaining units.

Series-parallel distribution (*c*) is merely a combination of the other two, and requires no special consideration, once the principles underlying the series and the parallel systems are understood. A common example of series-parallel connection is found in the lighting circuits of a trolley car, where several strings of five 110-volt lamps in series are each connected across the 550-volt supply circuit.

If in a constant potential (parallel) system there are N lamps (or other load units) each taking i amperes, the total current supply is Ni amperes, and the power consumed, neglecting the loss in the line, is $Ni E$ watts, where E is the line voltage. In a constant current (series) circuit, if there are N lamps each requiring e volts and i amperes, the total impressed e.m.f. must be Ne volts and the power consumed will be $Ne i$ watts, again neglecting the line loss. In the first case (parallel system) the line conductor must have a cross-section at the supply end capable of carrying Ni amperes, and gradually tapering off as the end of the line is approached. In the second case (series system) the line conductor will be of uniform cross-section from end to end, since the current is everywhere the same, but the difference of potential between the supply lines will be large at the generator end (G) and will gradually decrease as the distance from the generator increases. The parallel system requires a much greater weight of copper in the line than the series system, but this disadvantage is offset by the fact that the high voltage required in a series circuit of any considerable power limits the use of series circuits to outdoor service. Thus, if 125 arc lamps, each consuming approximately 50 volts, are connected in series, the total voltage consumed by the lamps will be 6250 volts; adding to this the voltage consumed in overcoming the resistance of the line, the e.m.f. required at the generator will be of the order of 7000 to 8000 volts, or much too high for safety in indoor service.

Although the parallel system of distribution is ordinarily called the constant-potential system, it will be readily apparent that the difference of potential between the conductors will vary more or less from point to point, becoming less as the distance

from the generator increases, because of the drop of potential due to the resistance of the line wires. This drop of potential due to ohmic resistance may be reduced to any desired amount by increasing the cross-section of the conductor, but it is clear that a limit is set by the rapidly increasing cost of the conductors. If the lamps (or other translating devices) are grouped at a distance from the generator, the voltage at the lamps may be kept constant, irrespective of the current in the feeder circuit, provided the voltage of the generator is raised, as the load increases, to a sufficient extent to compensate the drop of potential in the line.

104. Characteristic Curves.—In view of the various types of service requirements described above, it becomes important to investigate the characteristic behavior of the usual types of generators in order to determine the kind of service to which each is adapted. Probably the simplest way to study and compare the several kinds of machines is to construct *characteristic curves* which show the relations between the variables involved in the operation of the machine. For example, the *external characteristic* of a generator is a curve showing the relation between terminal voltage, plotted as dependent variable, and external (line) current, plotted as independent variable. Other characteristic curves are discussed in following articles.

105. Regulation.—In the case of a generator, the terminal voltage at full load is generally different from that at no load. The difference between the two values is then a measure of the closeness with which the machine regulates for constant voltage; the difference is called the *voltage regulation*. In order to make this measure a perfectly definite one, so that machines of different makes and sizes may be compared, the Standardization Rules of the American Institute of Electrical Engineers define the *percentage voltage regulation* (or simply the *regulation*) as the *difference between the full-load and no-load voltages, divided by the full-load voltage, and multiplied by 100.*¹

¹The new (1914) Standardization Rules define percentage regulation as "the percentage ratio of the change in the quantity occurring between the two loads to the value of the quantity at either one or the other load, taken as the normal value." Inasmuch as the full-load voltage is usually considered the normal voltage, it would be used as the divisor in obtaining the percentage regulation, hence the definition given above.

Similarly, if a machine is designed to regulate for constant current, as an arc-light generator, its regulation would be computed in like manner by dividing the difference between full-load and no-load currents by the full-load current. The speed regulation of a motor, engine, turbine, etc., would be similarly defined in terms of speeds at full-load and at no-load.

106. Characteristic Curves of Separately Excited Generator.—

The following symbols will be used:

E = generated e.m.f.

E_t = terminal voltage

r_a = resistance of armature, including brushes and brush contacts

r_f = resistance of field winding

R = resistance of external load circuit

i = current taken by load

i_f = current in field winding

n_f = field turns per pair of poles

n = speed of rotation, r.p.m.

No-load Conditions.—Under no-load conditions, the armature being driven at its rated speed, the relation between the e.m.f.

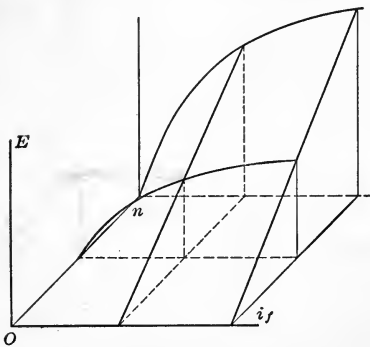

FIG. 150.—Effect of variation of speed upon magnetization curve.

generated in the armature winding and the exciting current in the field winding is given by the magnetization curve discussed in Chap. IV (see Fig. 100). Since the generated e.m.f. is given by the equation

$$E = \frac{p}{a} \cdot \frac{\Phi Z n}{60 \times 10^8}$$

it follows that if Φ is kept constant (by keeping i_f constant), the generated e.m.f. will be directly proportional to the

speed. If, then, E , i_f , and n are plotted along three axes of coordinates, there will result a surface of the kind illustrated in Fig. 150. Sections of the surface cut by planes parallel to the (E, n) plane are straight lines whose slope increases as the distance of the section from the (E, n) reference plane increases

—at first rapidly, then more slowly. Sections cut by planes parallel to the (E, i_f) plane are magnetization curves corresponding to the speed represented by the distance of the secant plane from the origin of coordinates.

External Characteristic. Load Conditions.—With the connections shown in Fig. 151, let the machine be driven at its rated speed, the field excited by a constant current i_f , and the brushes set with an angular lead α most favorable for good commutation. The line current (which is here the same as the armature current)

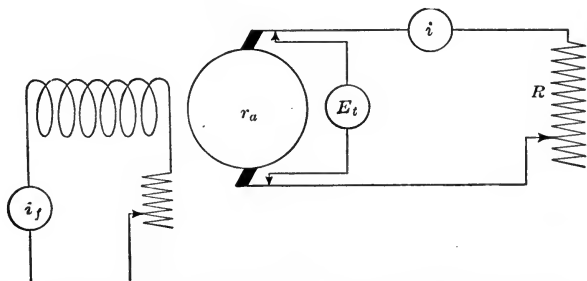

FIG. 151.—Connections for determining no-load characteristic. Separate excitation.

will vary as the external load resistance R is varied, and the terminal voltage E_t will be less than the generated e.m.f. E by ir_a volts, the latter being consumed in the internal resistance of the armature. That is,

$$E_t = E - ir_a \quad (1)$$

In this expression r_a comprises not only the resistance of the armature winding itself, but the resistance of the brushes and their connections, including the contact resistance between commutator and brushes. While the resistance of the armature is constant when the steady working temperature has been reached, the contact resistance is not constant, but varies approximately inversely as the current; that is, the total drop of potential at the contact surface between commutator and brushes is approximately constant, and is of the order of 2 volts with ordinary grades of carbon brushes, provided the current per sq. in. of contact area does not exceed 45 amperes (or 5 to 7 amperes per sq. cm.).

In the case of copper brushes, which are used only with low-voltage machines, the contact drop is of the order of 0.04 volt with current densities ranging from 65 to 160 amperes per sq. in. (10 to 25 amperes per sq. cm.).

Strictly, therefore,

$$E_t = E - ir'_a - \Delta e \quad (2)$$

where r'_a is the constant part of the armature resistance, and Δe is the drop over the variable contact resistance. In what follows this correction is ignored for the sake of simplicity.

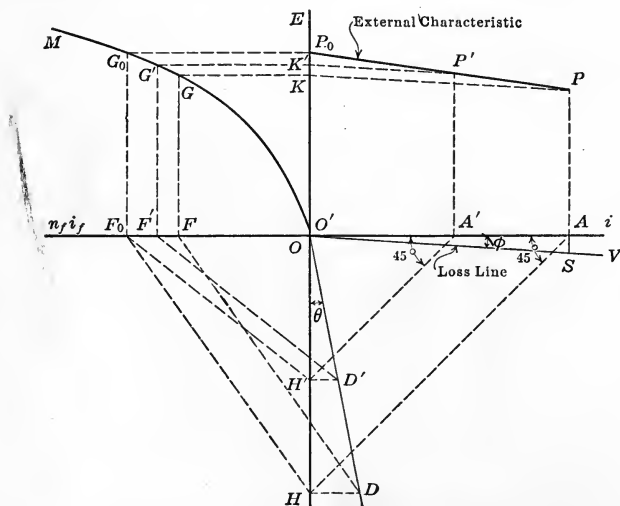

FIG. 152.—Construction of external characteristic of separately excited generator.

In Fig. 152 let $O'M$ be the magnetization curve plotted with ampere-turns per pair of poles ($n_f i_f$) as abscissas and generated e.m.f. (E) as ordinates. If the excitation is adjusted by means of the field rheostat (Fig. 151) until it has the value represented by the abscissa OF_0 , the generated e.m.f. will be $F_0G_0 = OP_0$, and this will also be the terminal voltage when the machine is running on open circuit ($i = 0, R = \infty$).

On closing the external circuit through a load R of such resistance that a current of i amperes is drawn from the machine, the terminal voltage drops below its no-load value; (1) because the demagnetizing action of the armature reduces the useful

flux Φ , and therefore also the generated e.m.f. E ; (2) because of the drop in the armature, $i r_a$. In Fig. 152 let OA represent any value of load current (i) and draw AH at an angle of 45 deg. so that $OH = OA = i$. Draw OD at an angle θ such that

$$\tan \theta = \nu \frac{\alpha Z}{180a} \quad (3)$$

to the scale of the figure, then the intercept $HD = \nu \frac{\alpha Z i}{180a}$ = demagnetizing ampere-turns per pair of poles. Join H and F_o , and draw DF parallel to HF_o . Then OF is the resultant field excitation, and $FG = OK =$ generated e.m.f. (E). Draw the line OV through the origin at an angle φ , such that

$$\tan \varphi = r_a$$

to the scale of the figure. The intercept AS will then equal $i r_a$ to the scale of volts, and if AS is deducted from OK (by drawing KP parallel to OV), the difference, or AP , will be the terminal voltage corresponding to the current $OA = i$. If the load current has a value represented by OA' , the change being brought about by a change in the load resistance, a similar construction, indicated in the figure, shows that the corresponding terminal voltage is $A'P'$. The locus of all such points as P, P' , etc., is then the *external characteristic* of the machine. The line OV whose ordinates represent the ohmic drop in the armature is sometimes called the *loss line*.

This method is subject to small errors because of the fact that it neglects a possible demagnetizing effect due to cross magnetization (Chap. V) and also due to the short-circuit currents in the coils undergoing commutation. The former may be taken into account, if necessary, by slightly increasing the angle θ .

It will be observed that the form of the external characteristic P_oP is dependent upon the form of the magnetization curve $O'M$, as well as upon the angles θ and φ . There will be a different characteristic corresponding to each setting of the field excitation, OF_o . The student will find it very instructive to run through the construction using a value of field excitation such that the point G_o falls on, or slightly below, the knee of the magnetization curve.

107. Effect of Speed of Rotation on the External Characteristic.—For a given value of the excitation and, therefore, of the

terminal voltage will then be $E_t = IR$, represented in Fig. 154 by the ordinate OA . At no-load this terminal e.m.f. would require an excitation $AB = OC$, but under the assumed conditions the generated e.m.f. must be greater than OA by an amount DF , where $DF = Ir_a$, that is, the e.m.f. required to be generated to yield a terminal voltage $E_t = OA$ is DG , corresponding to an excitation OG . Finally, because of armature demagnetizing effect, the field excitation must be still further increased to OK , where

$$GK = \nu (AT)_d$$

An ordinate through K then intersects AB (extended) in the point P , which point accordingly lies on the load characteristic corresponding to full-load current.

Since DF and $GK = FP$ remain constant in magnitude as long as $i = I$, the load characteristic is the same in shape as the no-load characteristic, but shifted downward and to the right by the constant length DP , as shown by the series of shaded triangles.

This construction is not strictly accurate, for with increasing excitation the demagnetizing component of cross-magnetization becomes greater, especially if the iron is saturated; in other words, FP should increase in magnitude as the curve rises.

Further, remembering that the coefficient of dispersion, ν , is itself not constant, but that it increases with increasing excitation (X increasing, equation (34), Chap. IV), it is clear that this feature will contribute to a further increase in FP .

109. The Armature Characteristic.—It is evident from Fig. 154 that if the terminal voltage is to be maintained constant for all values of the load current, the excitation must be increased as the load increases. Thus, an increase in the current from $i = 0$ to $i = I$ requires an increase of excitation from OC to OK

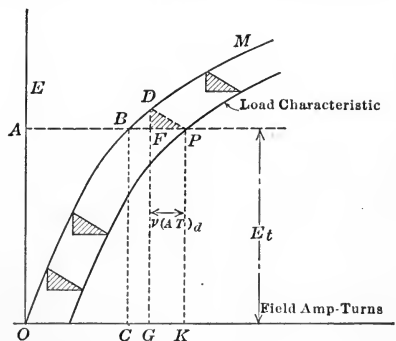

FIG. 154.—Construction of load characteristic, separately excited generator.

in order to maintain a terminal voltage equal to OA . The curve showing the relation between field excitation (as ordinate) and load current (as abscissa), under the condition of constant terminal voltage is commonly called the *armature characteristic* (Fig. 155) though a better name would be "regulation curve."

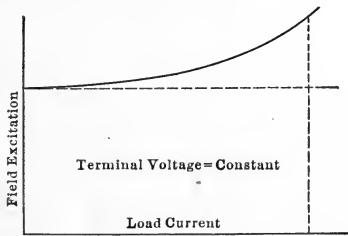

FIG. 155.—Armature characteristic or regulation curve.

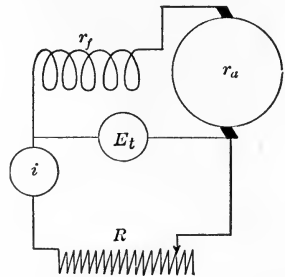

FIG. 156.—Connections of series generator, determination of external characteristic.

110. Characteristic Curves of the Series Generator.—*External Characteristic.*—

- Let E = generated e.m.f.
 E_t = terminal voltage
 i = current in the circuit
 r_a = resistance of armature winding, including brushes and brush contacts
 r_f = resistance of series field winding
 n_f = series field turns per pair of poles
 R = resistance of external circuit
 n = speed in r.p.m.

Since the same current (i) flows through the armature, the field winding, and the load circuit (Fig. 156), it follows that an increase of load causes an increase of excitation and therefore also of generated e.m.f., the speed of rotation being kept constant at its rated value. The external characteristic will have the form of curve III, Fig. 157. If, then, to the ordinates of curve III there be added the ordinates of the loss line, curve II will result. Curve II is the *internal characteristic*, showing the relation

between the internally generated e.m.f. and the armature current. This follows because

$$E = E_t + i(r_a + r_f) \tag{4}$$

If there were no armature reaction, curve II would be the magnetization curve of the machine; but in the actual machine, where armature reaction exists, the magnetization curve (I) is displaced from curve II in the manner indicated in the figure. Thus, of the excitation OA required to produce terminal voltage AP and generated e.m.f. AG , a part, DG , is required to balance the demagnetizing component of armature reaction. The remainder, or OF , is then responsible for the generated e.m.f., hence D is a point on the magnetization curve.

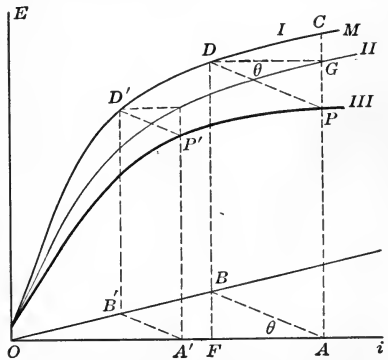

FIG. 157.—External characteristic of series generator.

Repeating this process to find other points, such as D' , it will be seen that the size of the triangle PGD must be altered from point to point. But since PG and DG are both proportional to the current, i , their ratio, and consequently the slope of DP , will remain constant. This leads to the following simple construction for obtaining the external characteristic from the given magnetization curve of the machine.¹

The demagnetizing effect AF corresponding to any current $i = OA$ is given by

$$v \cdot \frac{\alpha Zi}{180 a} - \frac{1}{n_f}$$

to the scale of current, and the length FB is equal to ir_a to the scale of volts. These two lengths, when laid off as in Fig. 155, locate the point B , therefore also the line OB . To find a point P' on the external characteristic corresponding to current OA' , draw

¹ This is the same construction given in Arnold's Die Gleichstrommaschine, Vol. I.

$A'B'$ at an angle $\theta = \tan^{-1} \frac{r_a}{\nu \alpha Z}$, through B' draw $B'D'$ vertically until it intersects curve M in D' , and draw $D'P'$ parallel to $B'A'$ until it intersects the ordinate through A' in the point P' .

111. Dependence of the Form of the Characteristic upon Speed.—Variation of the speed of a series generator affects the magnetization curve in exactly the same manner illustrated in Fig. 150 for the case of the separately excited generator. Thus, in Fig. 158, the surface bounded by $OD'D$ is the locus of the

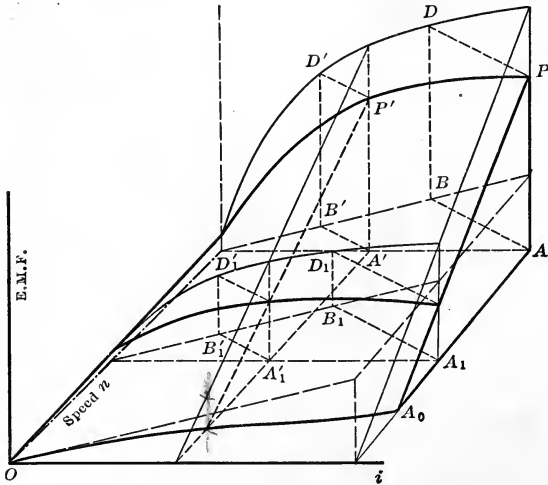

FIG. 158.—Effect of variation of speed upon external characteristic of series generator.

magnetization curves for various values of speed laid off along the speed axis n . Corresponding to each magnetization curve there will be an external characteristic constructed as in Fig. 157, and the locus of all such external characteristics will be a surface indicated by the heavy lines, as OA_0P . The intersection of this surface with the base (n, i) plane is a curve OA_0 , which shows the relation between speed and current when the machine is short-circuited ($E_t = 0$).

112. Condition for Stable Operation.—Referring to Fig. 156, it will usually be found that when the machine is driven at its

rated speed there is a critical value of the load resistance R above which the machine will fail to generate, or to "build up." When the load resistance has been lowered slightly below this critical value, the terminal voltage and current will at first rise rapidly and then more slowly until a condition of equilibrium is reached, but between the initial and final condition the machine is in a state of unstable electrical equilibrium. Further reduction of R will cause the current and e.m.f. to change, but there is no further evidence of instability.

The reason for this behavior will be evident from a consideration of Fig. 159, in which the curve represents the external characteristic of the generator. It is evident from Fig. 156 that Ohm's law must hold for the external circuit, or

$$E_t = iR$$

This is the equation of a straight line through the origin, the slope of the line being proportional to R . Thus, OR_1 , OR_2 , OR_3 , etc., correspond to successively smaller values of R , and these lines are characteristic of the

external circuit. Since the points representing simultaneous values of E_t and i must satisfy the characteristics of both generator and external circuit, the point of equilibrium will be at their intersection. Thus, when the external resistance is high, as R_1 , the terminal voltage and current will be represented by the coordinates of point P_1 . When $R = R_2$, the line OR_2 coincides for a greater or lesser range with the external characteristic, hence there is unstable equilibrium between the points P'_2 and P''_2 . Values of R such as R_3 and R_4 will give stable equilibrium at points P_3 and P_4 , respectively.

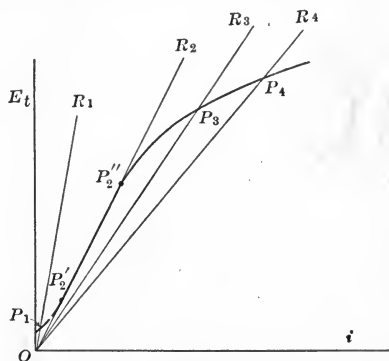

FIG. 159.—Condition for stable operation of series generator.

113. Regulation for Constant Current.—Inspection of the construction of Fig. 157 will show that the external characteristic of a series generator will droop more and more as the armature reaction and internal voltage drop become greater. In fact, by

purposely exaggerating the magnitudes of these two quantities, the characteristic may be made to bend over to such an extent as to become nearly vertical, in which case the machine has an inherent tendency to regulate for constant current.

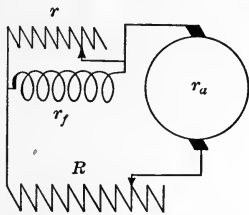

FIG. 160.—Diagram showing connections of constant current generator.

Such a characteristic is desirable for series arc circuits, and some of the older types of Brush arc-light generators were designed on this principle. Another method of regulating a series generator to make it deliver a constant current is to provide a variable resistance shunted around the series-field winding, as in Fig. 160. It is clear that a portion of the exciting current is then by-passed around the winding, thereby cutting down the generated e.m.f. Every variation of the resistance of the load must then be accompanied by a corresponding change of the regulating shunt. The relation between the resistance of the regulating shunt and the corresponding terminal voltage of the machine is shown in a simple manner in Fig. 161.

Let OM be the magnetization curve, with abscissas equal to the current in the field winding (instead of ampere-turns), and let $OA = i$ be the constant current that the machine is required to develop; in other words, the external characteristic is to be the vertical line AY . Lay off AB to any convenient scale equal to the resistance (r_f) of the series field winding, and to the same scale lay off BC equal to any arbitrarily selected value of the resistance (r) of the regulating shunt. AB will be fixed in magnitude while BC will be variable. Vertically upward from A set off $AD = ir_f =$

inherent tendency to regulate for constant current. Such a characteristic is desirable for series arc circuits, and some of the older types of Brush arc-light generators were designed on this principle.

Another method of regulating a series generator to make it deliver a constant current is to provide a variable resistance shunted around the series-field winding, as in Fig. 160. It is clear that a portion of the exciting current is then by-passed around the winding, thereby cutting down the generated e.m.f. Every variation of the resistance of the load must then be accompanied by a corresponding change of the regulating shunt. The relation between the resistance of the regulating shunt and the corresponding terminal voltage of the machine is shown in a simple manner in Fig. 161.

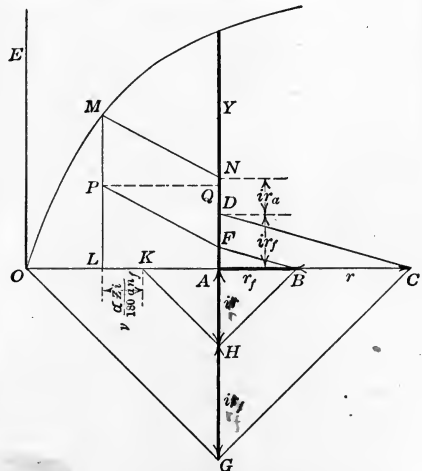

FIG. 161.—Regulation for constant current, graphical solution.

of the series field winding, and to the same scale lay off BC equal to any arbitrarily selected value of the resistance (r) of the regulating shunt. AB will be fixed in magnitude while BC will be variable. Vertically upward from A set off $AD = ir_f =$

constant, also $DN = ir_a = \text{constant}$, and downward from A set off $AG = OA = i = \text{constant}$.

The total current, i , will divide between r_f and r in such a manner that

$$i_r + i_{r_f} = i \quad (5)$$

and

$$\frac{i_r}{i_{r_f}} = \frac{r_f}{r} \quad (6)$$

Hence, if C and G are joined by a straight line and BH is drawn parallel to CG , point H will divide $AG = i$ into two parts, such that $AH = i_r$ and $HG = i_{r_f}$. Joining G and O , and drawing HK parallel to GO , OK will be the current through the series-field winding. Setting off $KL = \nu \frac{\alpha Zi}{180an_f}$, or the equivalent demagnetizing current of the armature, OL will be the net excitation of the machine, and LM the corresponding generated e.m.f.; if MP is the ohmic drop in the machine, or $i\left(r_a + \frac{rr_f}{r + r_f}\right)$, the terminal voltage will be $E_t = LP = AQ$. To find MP graphically, proceed as follows: Connect C and D and draw BF parallel to CD ; then $DF = i \frac{rr_f}{r + r_f}$ and $NF = i\left(r_a + \frac{rr_f}{r + r_f}\right)$. Therefore, point P is found by joining M and N and drawing FP parallel to MN . Finally, therefore, AQ is the terminal voltage corresponding to the shunt resistance $r = BC$. Other points may be found by exactly similar construction.

It will be evident from the above discussion that the voltage of a series generator can also be controlled by varying the position of the brushes, thereby changing angle α and affecting the length KL in Fig. 161.

114. Characteristics of the Shunt Generator.—*Open-circuit Conditions.*—Let

- E = generated e.m.f.
- E_t = terminal voltage
- i_a = armature current
- i = external or line current
- i_s = shunt-field current
- r_a = armature resistance

- r_s = shunt-field resistance, including regulating rheostat
 R = resistance of external load circuit
 n_s = field turns per pair of poles
 n = speed in r.p.m.

When the load or receiver circuit of a shunt generator is disconnected, as in Fig. 162, the armature and shunt field constitute a simple series circuit identical with that of Fig. 156. It is therefore easily seen that variation of the shunt-field rheostat will give rise to changes in E_t and i_s in the manner already discussed in the case of the series generator. There is, however, this difference,

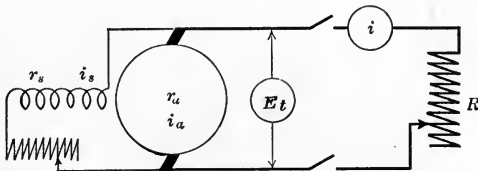

FIG. 162.—Connections of shunt generator. Determination of external characteristic.

that the high resistance of the shunt-field winding will limit the flow of current (i_s) to values that are small compared with the current carrying capacity of the armature, therefore the observed readings of E_t under the conditions assumed will not differ appreciably from E , the total generated e.m.f. Thus, with the external circuit open

$$E = E_t + i_s r_a \cong E_t \quad (7)$$

since both i_s and r_a are small. Moreover, the small flow of current in the armature means negligibly small armature reaction, hence the relation between E_t and i_s will be closely represented by the magnetization curve of the machine.

Since $i_s = \frac{E_t}{r_s}$, the effect upon the terminal voltage of changing the value of r_s will be given by a construction identical with that of Fig. 159; generally there will be a region of unstable equilibrium in the building up of the generated e.m.f.

The External Characteristic.—The form of the external char-

acteristic showing the relation between terminal voltage E_t and line current i can be determined by the following method:¹ From Fig. 162 it is evident that

$$E = E_t + i_a r_a \quad (8)$$

$$i_a = i + i_s \quad (9)$$

$$i = \frac{E_t}{R} \quad (10)$$

$$i_s = \frac{E_t}{r_s} \quad (11)$$

The relation between the generated e.m.f., E , and the field excitation, $n_s i_s$ (ampere-turns per pair of poles), is given by the magnetization curve, M , Fig. 163. If the machine is running on open circuit ($R = \infty$), let the resistance of the field rheostat be so adjusted that the excitation is represented by OF_0 , the generated e.m.f. then being $F_0 L$; this will then be nearly equal to the terminal voltage on open circuit, neglecting the small drop ($i_s r_a$) in the armature. The line ON is then the "field resistance" line, its slope being $\frac{E_t}{n_s i_s} = \frac{r_s}{n_s}$, that is, proportional to r_s ; it corresponds to the lines OR_1 , OR_2 , etc., of Fig. 159.

Now let the external circuit be closed, R being so adjusted that a moderate current will flow. Then, even were the excitation to remain constant, as in the separately excited generator, the terminal e.m.f. would fall because of the ohmic drop in the armature winding, *i.e.*, from equation (8)

$$E_t = E - i_a r_a \quad (12)$$

But, in the case of the shunt machine, a decrease of terminal voltage is accompanied by a proportionate decrease of excitation, since $i_s = \frac{E_t}{r_s}$, hence, when there is an appreciable load current flowing, the flux and the generated e.m.f. are reduced, thereby causing a further reduction of E_t . It is clear, therefore, that the greater the load current the less will be the terminal voltage, and that the drop of terminal voltage will be greater in the shunt machine than in the separately excited machine, other things being equal.

Suppose that the load has been increased to such a value that

¹ Franklin and Esty, Elements of Electrical Engineering, Vol. I.

the terminal voltage has fallen to the value CV , Fig. 163; the problem is then to locate the point P on the horizontal line CVP such that P is a point on the external characteristic.

Through V draw the horizontal line VC intersecting ON in C ; then OF represents to scale the new value of $n_s i_s$. If there were no armature reaction, the ordinate FG would be the total generated e.m.f. corresponding to the excitation $n_s i_s = OF$, and, therefore, since

$$i_a r_a = E - E_t$$

CG would represent to scale the value of $i_a r_a$. But since armature reaction does exist, the net excitation is less than OF by an amount FD , where

$$FD = \nu \frac{\alpha Z i_a}{180 a}$$

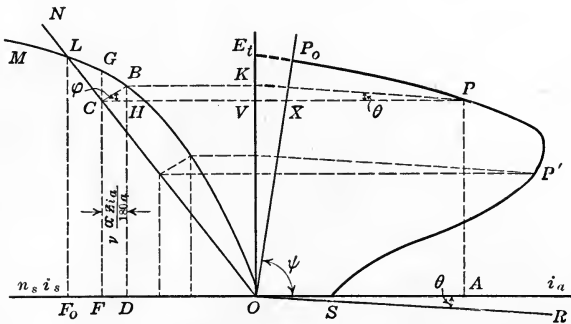

Fig. 163.—Construction of external characteristic of shunt generator.

Actually, therefore, the net excitation is OD , and the generated e.m.f. is $E = BD$

$$\therefore i_a r_a = E - E_t = BD - HD = BH$$

and

$$\frac{BH}{CH} = \frac{BH}{FD} = \frac{i_a r_a}{\nu \frac{\alpha Z i_a}{180 a}} = \frac{180 a r_a}{\nu \alpha Z} = \tan \varphi = \text{constant.}$$

In other words, when a point C on the field resistance line ON has been fixed, point B is found by drawing through C a line CB making the fixed angle φ with the horizontal.

Through B draw the horizontal line BK , and through K draw

KP at an angle θ with the horizontal, this angle being so chosen that

$$\tan \theta = r_a$$

to the scale of the figure. It follows, then, that

$$VP = \frac{KV}{\tan \theta} = \frac{i_a r_a}{r_a} = i_a$$

hence P is a point on a curve whose ordinates are terminal voltage (E_t) and whose abscissas are total armature current (i_a). Corresponding values of line current (i) can then be found by subtracting i_s ; this can be done graphically by drawing the line OP_o at an angle ψ such that $\tan \psi = r_s$ to the scale of the figure; for it is easily seen that

$$VX = \frac{OV}{\tan \psi} = \frac{E_t}{r_s} = i_s$$

Hence $AP = E_t$ and $XP = i$ are simultaneous values of terminal voltage and line current. Similar construction will then serve to locate additional points, such as P' , as illustrated in Fig. 163.

It will be observed that the external current at first increases as the load resistance is lowered, but that eventually a critical point is reached beyond which a further lowering of the external resistance causes the current to decrease rapidly. The terminal voltage falls steadily throughout the entire process, becoming zero when the machine is dead short-circuited ($R = 0$); under this condition of complete short-circuit the external current is not zero but has a small value OS due to the fact that residual magnetism generates a small e.m.f. that is entirely consumed in driving the current through the armature resistance. It might be inferred from these facts that a shunt generator can be short-circuited without danger, but this is not the case except in very small machines; for the critical point at which the line current begins to decrease is generally far beyond the current-carrying capacity of the armature, and the winding will burn out before the current has had time to decrease to a safe value.

115. Dependence of the Form of the Characteristic upon Speed.—The diagram of Fig. 163 was drawn subject to the condition that both the speed and the resistance of the shunt circuit remain constant. A change in speed (r_s remaining the same)

will alter the form of the characteristic, and the new relations between E_t , i_a and n can be most easily shown by a three-dimensional diagram such as Fig. 164. In this figure the surface OO_1M , drawn to the left of the speed axis, is the locus of the magnetization curves for various values of speed, and to each magnetization curve there will correspond a characteristic L_1, L'_1 , etc., the locus of which has the peculiar tubular form shown in the diagram.

If the shunt field resistance has a constant value, the locus of the field resistance lines (ON) will be plane OO_1N , and the intersection of this plane with the magnetization surface OO_1M

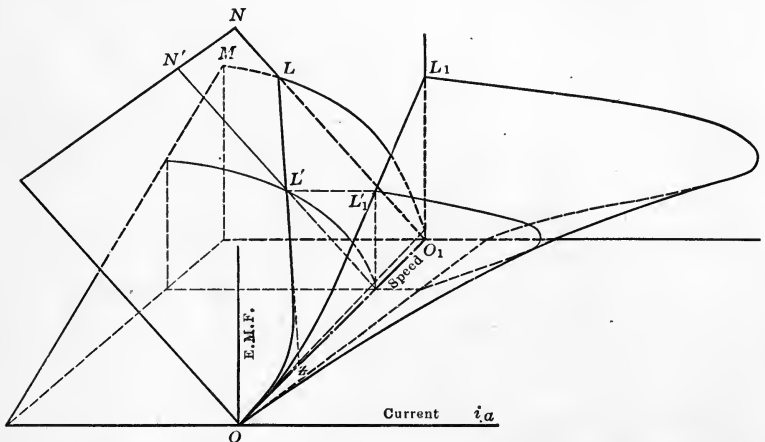

FIG. 164.—Effect of variation of speed upon external characteristic of shunt generator.

will be a curve $OL'L$. The projection of this curve on the (E_t, n) plane will give curve OL'_1L_1 , which shows the relation between terminal voltage and speed when the generator is operating on open circuit. If there were no residual magnetism, curve $OL'L$ would not pass through the origin, but would intersect the speed axis in a point Z ; that is, if there were no residual magnetism, the machine would fail to build up for any speed below a critical speed, OZ .

116. Dependence of Form of Characteristic upon Resistance of Shunt Field Circuit.—If the speed of a shunt generator is kept constant and the resistance of the field circuit is varied by means

of the regulating rheostat, the size and shape of the characteristic will be affected in the manner shown in Fig. 165. OM is the magnetization curve corresponding to the speed at which the machine is driven, and ON_1, ON_2 , etc., are the field resistance lines corresponding to the setting of the rheostat. The construction of the several characteristics is carried out in the manner described in connection with Fig. 163.

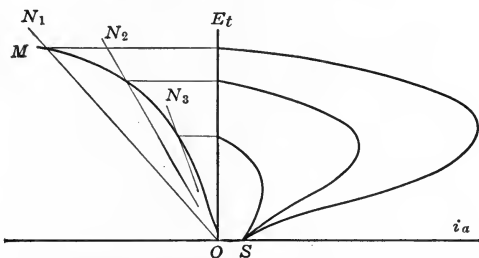

FIG. 165.—Effect of variation of shunt regulating resistance upon external characteristic of shunt generator.

117. Approximate Mathematical Analysis of Shunt Generator Characteristics.—It will be evident from the preceding articles that the form of the external characteristic is in all cases dependent upon that of the magnetization curve, hence an equation representing the relations between the variables E_t , i and n must be a function of the equation representing the magnetization curve. Since the latter would necessarily involve a relation between B and H for the iron comprising part of the magnetic circuit, and since such a relation is entirely unknown, the best that can be done is to represent the magnetization curve by an empirical equation originally due to Froelich, as follows:

$$E = \frac{an i_s}{b + i_s} \quad (13)$$

where a and b are constants, and n is the speed. If the speed is held constant, this equation represents a hyperbola, with asymptotes as shown in Fig. 166. A suitable choice of the constants a and b will make this hyperbola agree very well with the actual magnetization curve within the working range of the machine, but it cannot be made to follow the irregularities in the actual curve at low magnetizations, and it does not take account of residual magnetism.

Using Froelich's equation, and ignoring armature reaction, we have the following relations (see equations 8, 9, 11 and 13):

$$E = \frac{an i_s}{b + i_s} = E_t + i_a r_a$$

$$i_a = i + i_s$$

$$i_s = \frac{E_t}{r_s}$$

whence

$$E_t = \frac{an E_t}{br_s + E_t} - \left(i + \frac{E_t}{r_s}\right) r_a \quad (14)$$

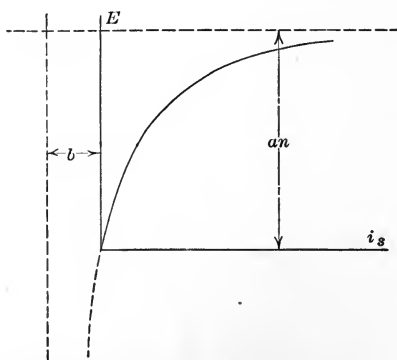

FIG. 166.—Empirical form of magnetization curve.

Solving for E_t , and simplifying by assuming that r_a is small compared with r_s (i.e., $r_a + r_s \cong r_s$) there is obtained

$$E_t = \frac{an - br_s - ir_a}{2} \pm \sqrt{\left(\frac{an - br_s - ir_a}{2}\right)^2 - ir_a r_s b}$$

$$= \frac{an - br_s - ir_a}{2} \pm \frac{1}{2} \sqrt{[an - (\sqrt{ir_a} - \sqrt{br_s})^2][an - (\sqrt{ir_a} + \sqrt{br_s})^2]} \quad (15)$$

This is an equation of the second degree between the three variables E_t , i and n , hence it represents a surface (Fig. 167) plane sections of which are conics or straight lines. Moreover, the surface is symmetrical with respect to the plane

$$E_t = \frac{an - br_s - ir_a}{2} \quad (16)$$

which is shown in the figure as ABC .

If in the general equation of the surface, (15), there is substituted $i = 0$, it is seen that

$$E_t = an - br_s \text{ and } E_t = 0; \tag{17}$$

the first of these two equations represents open-circuit conditions, the second, short-circuit conditions. From the former it appears that $E_t = 0$ when $n = \frac{br_s}{a} = OB$, hence OB is the critical speed below which the machine would fail to build up if residual magnetism were not present.

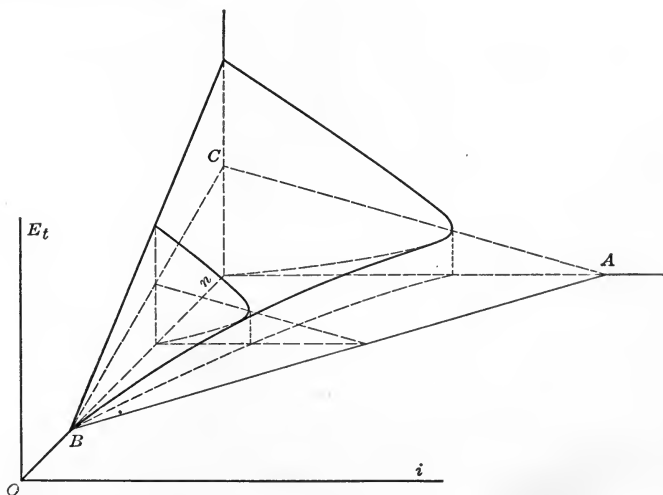

FIG. 167.—Idealized external characteristic surface of shunt generator.

Inserting in the general equation for E_t the condition $n =$ constant, there will result the equation of the external characteristic corresponding to the chosen value of speed. It is obvious that there are two values of the current (i) which will reduce the radical to zero, hence the characteristic intersects the plane ABC in two points; one of these values of current is $\frac{(\sqrt{an} - \sqrt{br_s})^2}{r_a}$

the other is $\frac{(\sqrt{an} + \sqrt{br_s})^2}{r_a}$. Between these values of current the radical becomes imaginary, hence the theoretical external characteristics are hyperbolas.

118. Characteristic Curve of the Compound Generator.—Long Shunt Connection.—The drop in terminal voltage between no-load

and full-load inherent in a shunt generator can be compensated, partially or wholly, or even overcompensated, by the addition of a series field winding excited by the armature current. As has been previously pointed out, the object of over-compounding is to keep the line voltage constant at a distant point, at or near the center of distribution of the load, the increase in the voltage at the generator terminals being consumed by the resistance of the line. In a general way the compound-wound generator (Fig. 168) may be considered as combining the rising character-

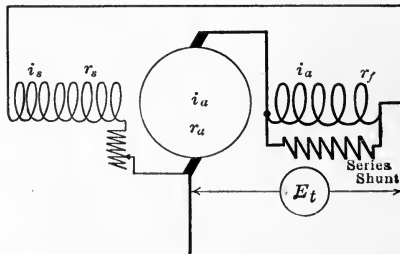

FIG. 168.—Connections of long-shunt compound wound generator.

istic of the series generator with the drooping characteristic of the shunt generator, the slope of the resulting curve depending upon the relative slopes of the components.

Starting as before with the magnetization curve, $O'M$, Fig. 169, the external characteristic can be constructed in a simple manner as follows:

Let ON be the shunt-field resistance line, its equation being

$$E_t = \frac{r_s}{n_s} (n_s i_s); \tag{18}$$

the intersection of this line with the magnetization curve determines a point L whose ordinate is (very nearly) the terminal voltage at no-load. Assuming that we are dealing with an over-compounded machine, let $F_1G_1 = AP$ be the terminal voltage corresponding to a value of $i_a = OA$ (the latter being supposed to be known). The field excitation due to the shunt turns will then be given by OF_1 , and the total field excitation will be OF_2 , where $F_1F_2 = n_f i_a$ is the excitation supplied by the series turns. The net excitation, or OF , will be less than this by an amount $FF_2 = v \frac{\alpha Z i_a}{180a}$ = demagnetizing ampere-turns per pair of poles,

hence the e.m.f. actually generated in the armature is FG . The difference between FG and F_1G_1 , or GH , must, therefore, be the drop in the armature and series field, or $i_a(r_a + r_f)$. Summarizing,

$$F_1F_2 = G_1G_2 = n_f i_a$$

$$G_2H = \nu \frac{\alpha Z}{180a} \cdot i_a$$

$$GH = (r_a + r_f) i_a$$

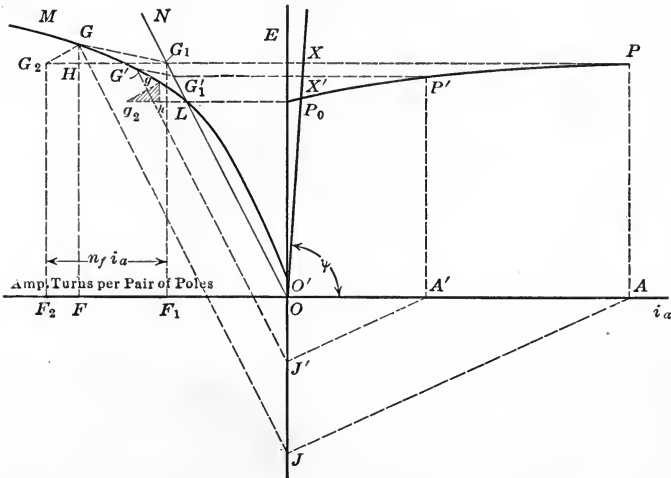

FIG. 169.—Construction of external characteristic of compound generator.

It follows, therefore, that all three sides of the triangle GG_1G_2 are proportional to i_a , hence their ratios remain fixed no matter what the value of i_a may be, and the angles at the vertices of the triangle are also constant. In particular, the slope of the side GG_1 is constant, and its length is proportional to i_a .

Through the point G draw GJ parallel to ON , J being on the axis of ordinates (prolonged downward); and join J with A . If, then, it is desired to find the terminal voltage, $A'P'$, corresponding to any other value of armature current, as OA' , draw $A'J'$ parallel to AJ , draw $J'G'$ parallel to JG until it intersects curve M in G' , and through G' draw $G'G'_1$, parallel to GG_1 , the point G'_1 being on the line ON . Draw G'_1P' horizontally until it intersects ordinate $A'P'$ in the point P' , then the latter is a point on the curve showing the relation between E_t and i_a .

If it is desired to show the relation between E_i and i , it is necessary to subtract the value of i_s from each corresponding value of i_a . To this end draw the line OX at an angle ψ with the horizontal, so that $\tan \psi = r_s$ to the scale of the drawing. Then PX and $P'X'$ are the values of i corresponding to i_a equal to OA and OA' , respectively.

It will be observed that this method presupposes a knowledge of the coordinates of at least one point on the characteristic. The chief value of the construction lies in the clearness with which it shows the intimate relation between the magnetization curve and the external characteristic. Thus, it becomes evident from the diagram that the external characteristic will approach a linear form more and more nearly as the magnetization curve flattens out (that is, when the figure LG_1G approaches triangular shape). If the point L is so placed that it is below the knee of the curve, the external characteristic will become more and more convex (from above), the curvature being considerable for small values of the load and less pronounced as the load increases. Considerations of this kind become important when the specifications of a machine call for a compounding that shall not depart from a linear relationship by more than a limited amount.

A study of Fig. 169 shows that a reduction in the number of series turns will shorten G_1G_2 and will make the characteristic more nearly horizontal. If it is desired to make the terminal voltage at full-load equal to that at no-load, that is to say, to make the machine flat-compounded, GG_1G_2 (assumed to correspond to full load conditions) will degenerate to Lgg_2 , where $g_2gh = G_2GH$. It is clear from the construction that the characteristic of a flat-compounded generator, like that of an over-compounded generator, cannot be exactly a straight line because of the curvature of the magnetization curve.

Short-shunt Connection.—In this case the current through the series winding is $i = i_a - i_s$, hence the construction of Fig. 169 is not strictly applicable. But at or near full-load the difference between i and i_a will be relatively small, especially in large machines, so that the above method will give a very close approximation to correct results.

119. The Series Shunt.—In practice it is quite common to design the series field windings of compound generators with a

sufficient number of turns to produce the maximum per cent. of compounding that may reasonably be specified. If a lesser degree of compounding is required, the magnetizing effect of the series winding is then reduced by connecting a shunt across the terminals of the series winding, as indicated in Fig. 168. This shunt is made of German-silver strip, and serves to by-pass a portion of the main current. The total current will divide between the series winding and its shunt in the inverse ratio of their resistances.

120. Connection of Generators for Combined Output.—When the load on a circuit exceeds the capacity of a single generator, one or more additional units must be connected to supply the excess. Thus, in a constant-current system in which the voltage varies in proportion to the load, additional generators must be connected in series when the voltage limits of the machine or machines already in service have been reached. Similarly, in constant potential systems, additional generators must be put in parallel with those already in service when the safe current-carrying capacity of the latter has been reached.

121. The Thury System.¹—The series system, in which series-wound generators, regulated to give constant current, are connected in series, has thus far found no application in the United States, save in those now obsolete plants in which constant-current motors were supplied from high voltage arc circuits. But in Europe this system has been developed to a high state of perfection through the work of M. Thury, who has installed a number of plants operating on this principle, most of them in Switzerland, Hungary and Russia.²

In the Thury system the series-wound generators are driven at constant speed and the current is kept constant by a regulating device which shifts the brushes (though it may be arranged to vary the speed). The regulating device is actuated by a solenoid through which the main line current flows. A sufficient number of generators are connected in series to develop the voltage required by the load. The load consists of series motors, also connected in series, which in turn drive generators (generally

¹ See also Chap. VII.

² Jour. Institution of Electrical Engineers, Vol. XXXVIII, p. 471. Electrical World, Vol. LXIII, No. 11, p. 583 (1914).

alternators) for the supply of current at the receiving or distributing end of the line. In other words, the system is generally used for the transmission of power over considerable distances, as distinguished from merely local distribution. The individual generators are grouped in pairs, each pair being driven by a water wheel (or other prime mover). In plants now operating, the maximum voltage per commutator is about 3600 volts, though it is possible to design machines of this type to give 5000 volts at 500

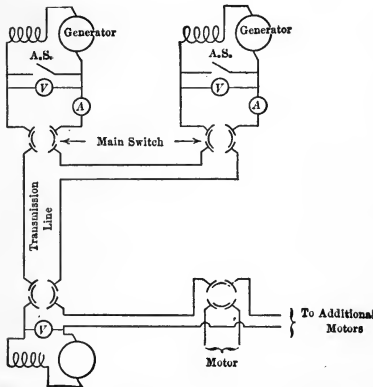

FIG. 170.—Diagram of connections, Thury system.

amperes, or 5000 kw. per pair of generators. The maximum line voltage in use at the Moutiers-Lyon plant is 57,600 volts, though a new installation projected for transmission from Trollhätten (Sweden) to Copenhagen—a distance of 200 miles—contemplates the use of a line voltage of 90,000 volts.¹

The starting and stopping of the generators in the Thury system is very simple. Each generator is equipped with an ammeter, a voltmeter, and a

switch, as in Fig. 170, the switch being so arranged that when it is in the "off" position the generator is short-circuited, and when in the "on", or running position, the machine is in series with the line. To start the machine, the switch being in the off position, the prime mover is brought up to normal speed, and the switch thrown to the running position when the ammeter reads normal current. To shut down the machine this process is reversed.

Since all of the machines are in series when under load, the potential of the circuit rises from generator to generator, hence the machines must be carefully insulated from earth to prevent breakdown of the insulation.

122. Parallel Operation of Generators.—

(a) *Series Generators.*—Series generators connected in parallel as in Fig. 171 will not operate satisfactorily, for the reason that

¹ Electrical World, Vol. LXI, p. 294, 1913.

if one of them suffers a momentary reduction of its output (as from a momentary drop in speed), both its voltage and current will be reduced, as may be seen from the form of the characteristic, Fig. 157. The other machine will then assume the part of the load dropped by its mate and its current and voltage will accordingly rise; the increased voltage will cause a further increase of current, hence an additional increment of load is thrown on the second machine and the load, current and voltage of the first will be still further reduced.

This process will tend to continue until the first machine is driven as a motor by the second machine; moreover, the direction of rotation of the former will reverse when it becomes a motor, so that the connecting rod of its driving engine will tend to buckle. Series generators connected in parallel are, therefore, in unstable equilibrium, there being no inherent tendency to bring about a proper division of the load between the two units under consideration. This is a consequence of the rising form of the external characteristic of the series generator.

The natural instability of series generators in parallel can be overcome by the *equalizing connection* shown in Fig. 171 as a dashed line. The effect of this connection is to put the series field windings in parallel with each other. If then one machine assumes more than its proper proportion of the total load, the excess current will divide between the two field windings, thereby raising the excitation and voltage of the machine which has momentarily dropped its load, hence automatically readjusting the division of the load.

(b) *Shunt Generators*.—The drooping form of the external characteristic of the shunt generator shows that if such a machine drops its load, its voltage will automatically rise. Consequently if two shunt generators are connected in parallel, as in Fig. 172, their operation will be stable. Any tendency which causes one machine to lose its proper share of current, thereby shifting an equal amount of current to the other, will result in a rise of vol-

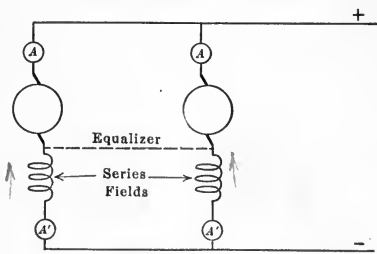

FIG. 171.—Series generators in parallel.

tage of the first machine and a drop in the voltage of the second. The original conditions will be restored, assuming that the prime movers are properly governed.

It is, of course, not necessary that the two (or more) generators thus connected in parallel should have the same ratings. But it is essential to good operation that the machines should divide the total load, whatever that may happen to be, in proportion to their ratings. Suppose, for instance, that two shunt generators that are to be connected in parallel have external characteristics as shown in Fig. 173, curve (a) representing the characteristic of one machine, curve (b) that of the other. In this figure ordinates are plotted in volts and abscissas in per cent. of full-load current. Since the machines are in parallel, their terminal voltages must necessarily be equal, hence if the load is such that the terminal voltage is OC , machine (a) will deliver OA per cent. of its rated current and machine (b) OB per cent. The condition to be satisfied is that $OA = OB$ at all loads, therefore it

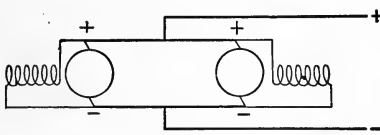

FIG. 172.—Shunt generators in parallel.

follows that if the load is to divide at all times in proportion to the ratings, the characteristics, when plotted in per cent. of full-load current, must be identical.

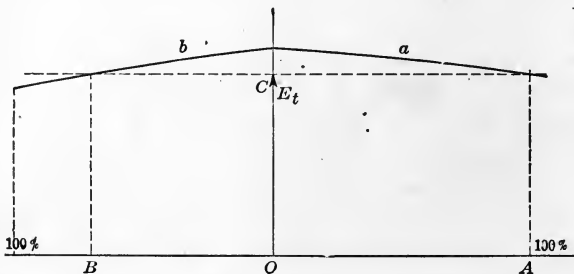

FIG. 173.—Division of load between shunt generators in parallel.

follows that if the load is to divide at all times in proportion to the ratings, the characteristics, when plotted in per cent. of full-load current, must be identical.

(c) *Compound Generators.*—Inasmuch as the compound generator partakes of the characteristics of both shunt and series generators, two or more of them, if over-compounded, will operate satisfactorily in parallel only when the series fields are provided

with the same equalizer connection shown in Fig. 171. This is a consequence of the rising characteristic. But if the machines have drooping characteristics, that is, if they are under-compounded, the equalizer is not necessary.

The diagrammatic scheme of connections of two compound generators in parallel is shown in Fig. 174. It is clear that if ammeters were connected as at A' , they would not indicate the true current actually delivered by the machines to the external circuit, for the readings would be affected by

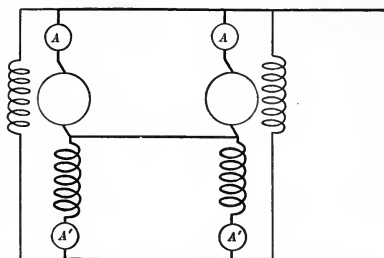

FIG. 174.—Compound generators in parallel.

the equalizing current. Thus, a heavily loaded generator might be supplying an equalizing current of large magnitude to the other lightly loaded machines and at the same time the ammeter of the loaded machine would read low while that of the

other machines would read high. For this reason the individual ammeters must be placed as at A , that is, in the lead that connects to the armature on the side *opposite* to the equalizing connection. For the same reason, if single-pole circuit-breakers are used, they should be placed in the same lead as the ammeters; thus, if two machines in parallel are each delivering full-load current and one of them should suffer a momentary drop in speed, the heavy equalizing current might open its circuit-breaker, if incorrectly placed, with the result that the entire load would be thrown on the other machine and so open its circuit-breaker also.

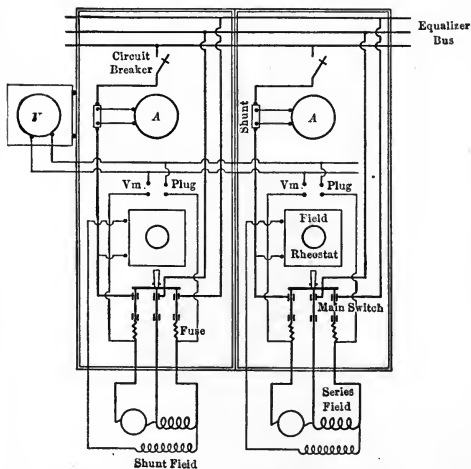

FIG. 175.—Diagram of switch-board connections, compound generators in parallel.

and one of them should suffer a momentary drop in speed, the heavy equalizing current might open its circuit-breaker, if incorrectly placed, with the result that the entire load would be thrown on the other machine and so open its circuit-breaker also.

The complete switch-board connections of two compound generators are shown in Fig. 175. The main switch and the equalizer switch are usually combined in a triple-pole switch.

The process of paralleling a compound generator with one or more that are already running is as follows: The main switch of the incoming machine being open and its circuit-breaker closed, the prime mover is brought up to speed and the voltage of the incoming machine adjusted to equality with the bus-bar voltage by manipulation of the shunt-field rheostat; the main switch is closed, and proper division of the load is then secured, if necessary, by further adjustment of the field rheostat. To shut down a machine running in parallel with others, its load is shifted to the others by weakening its shunt-field current, and the main switch is opened when the ammeter indicates a small, or zero, current.

If two compound generators are to divide the load in proportion

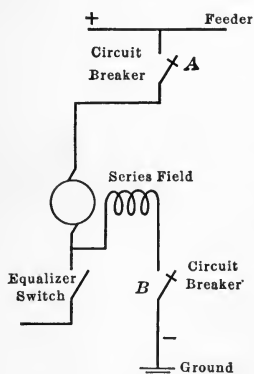

FIG. 176.—Diagram of connections of railway generator supplying grounded circuit.

to their ratings, their characteristics must obviously be identical in the manner explained in connection with shunt machines. Moreover, since the series fields are in parallel by virtue of the equalizer connection, the resistances of the series windings including the resistances of the respective equalizing leads, must be inversely proportional to the rated currents of the two machines. Neglect of this feature will result in a disproportionate division of load. For example, if the machines are at unequal distances from the switch-board, the resistance of the series field of the more remote machine will be unduly high because of the longer equalizing connection, and this machine will, therefore, not take its full share of the load.

The series field of a compound generator may be connected to either the positive or the negative terminal of the armature. In street-railway generators built by one well-known company the series field is connected on the negative, or grounded side; in this case it is not sufficient to use one single-pole circuit-breaker (A) on the positive or feeder terminal, but another circuit-

breaker (*B*) must be put in the lead to the grounded bus, as shown in Fig. 176. For if circuit-breaker *B* were not present and the armature winding were to become grounded to the core, the short-circuit current through the armature and series field would hold up the excitation and maintain the short-circuit without the possibility of protection by circuit-breaker *A*.

123. Three-wire Generators.—Economy in the use of copper in distributing circuits for lighting and power dictates the selection of high voltage and moderate current, rather than low voltage and large current; but in incandescent lighting, lamps designed for 110 to 115 volts are more efficient than those operating

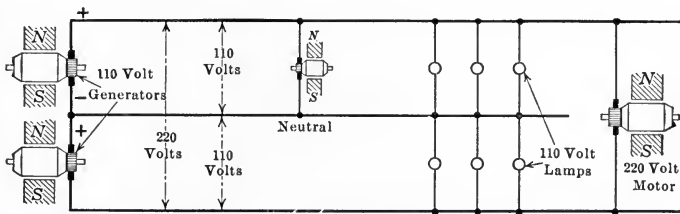

FIG. 177.—Three-wire system, two generators in series.

at higher voltages. To get the benefit of the high efficiency 110–115-volt lamp and at the same time to obtain the copper economy of higher voltage, the three-wire system of distribution diagrammatically illustrated in Fig. 177 is extensively used. The individual lamps, small motors and other translating devices are connected between the outer wires and the middle or *neutral* wire, and larger motors, designed to operate on the higher voltage of the system, are connected between the outer wires. In the early forms of three-wire systems, the splitting of the moderately high voltage between the outer wires was accomplished by using two generators in series (Fig. 177), the neutral being tapped into their common junction.

A later arrangement, shown in Fig. 178, consisted of a main two-wire generator wound for the voltage between the outside wires, with a *balancer set* connected across the outside wires. If the load on the two sides of the system, that is, between neutral and outer wires, were exactly balanced, no current would flow in the neutral, and the neutral might then be omitted; this is sometimes done in 220-volt systems, the lamps

being connected in series in pairs and connected across the main wires. But if the load is not exactly balanced, the neutral will carry a current equal to the difference between the currents supplied to the two sides of the system. The attempt is always made to balance the system as completely as possible, but provision is usually made for an unbalancing of about 10 per cent., that is, 10 per cent. of full-load current in the neutral wire. When a

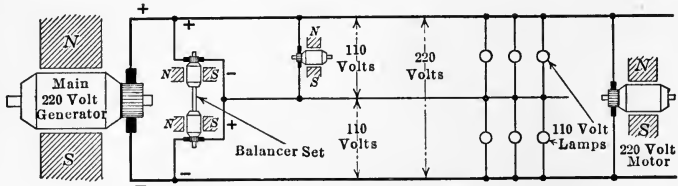

FIG. 178.—Three-wire system with balancer set.

system employing a balancer set becomes unbalanced, the voltage on the more lightly loaded side tends to be higher than on the more heavily loaded side; in this case, the machine on the side having the lighter load operates as a motor and drives the other as a generator; the latter then supplies current for the excess load on its side of the system, and thus automatically tends to balance the system. With perfect balance of load both machines of the balancer set operate as motors running without load.

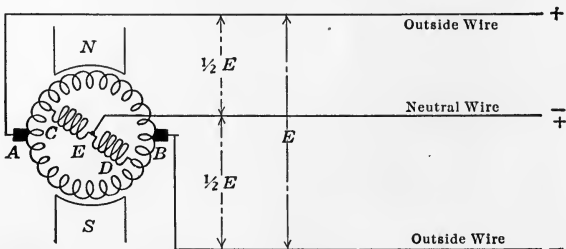

FIG. 179.—Three-wire generator with coil mounted inside armature core.

Systems of the kind shown in Figs. 177 and 178 are open to the objection that they involve the use of more than one piece of running machinery and so require extra attendance and maintenance, in addition to being higher in first cost and lower in efficiency than a single machine of the same capacity. These objections are overcome by a system originally devised by Do-

browsky, and shown diagrammatically in Fig. 179. A coil of wire, CED , wound on an iron core, is tapped into the main armature winding of the generator at the points C and D , 180 electrical degrees apart, that is, points that occupy homologous posi-

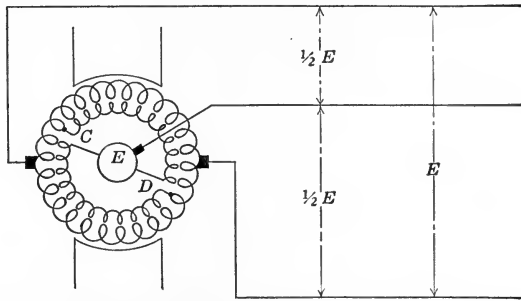

FIG. 180.—Three-wire generator with auxiliary winding in slots.

tions with respect to poles of opposite polarity. The difference of potential between C and D is alternating, so that the coil is traversed by an alternating current which goes through one cycle (two alternations) per revolution per pair of poles; this alternating current is small because of the large self-inductance due to the iron core on which the coil is wound. The middle point

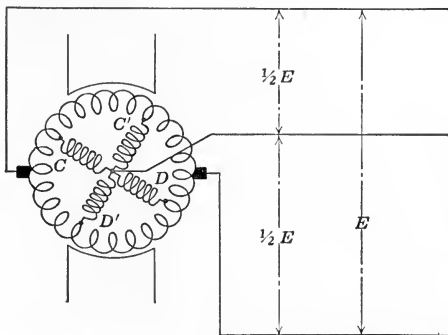

FIG. 181.—Three-wire generator with two coils tapped into armature winding.

of the coil, E , will have a potential midway between the potentials of C and D , and therefore also midway between the potentials of the brushes A and B , since the potentials of C and D are always symmetrically related to those of A and B , respectively.

A tap brought out from the point *E* may then be used as the neutral wire of a three-wire system. In machines of this kind built by the General Electric Company, the coil *CD* is wound on a core that is mounted inside the armature core, and the connection from the middle point *E* to the outside circuit is made through

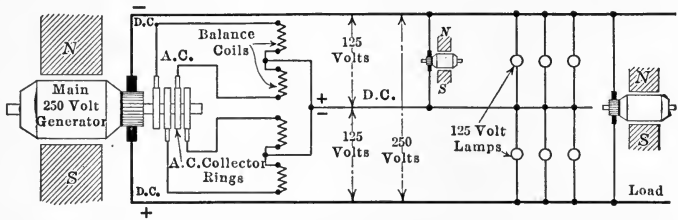

FIG. 182.—Three-wire generator with two auxiliary coils mounted externally.

a single slip-ring mounted on the main shaft of the generator. The Burke Electric Company builds a three-wire generator in which the coil *CD* is wound in the same slots that carry the main armature winding, in the manner indicated in Fig. 180.

The balance coil *CD* may also be placed outside of the genera-

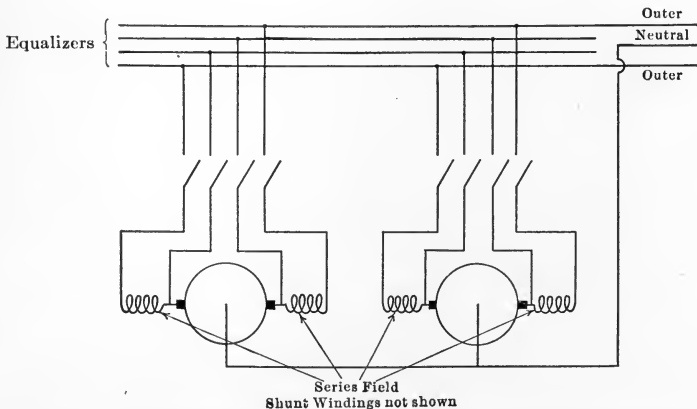

FIG. 183.—Diagram of connections of compound three-wire generators in parallel.

tor, connection to the armature winding being made in that case through two slip-rings; or two balance coils, connected to the armature winding as in Fig. 181, may be used. The alternating voltages between the points *C*, *D* and *C'*, *D'* are 90 electrical

degrees apart, that is, one of them is a maximum when the other is zero, and *vice versa*. Fig. 182 shows the connections when two balance coils, mounted externally to the generator, are used; this is the standard construction used by the Westinghouse Electric and Manufacturing Company.

If three-wire generators are to be compounded, the series field winding must be in two equal parts, half of the turns being in series with one of the outer wires, the other half in series with the other outer wire, as in Fig. 183. If two or more three-wire generators are to be operated in parallel, two equalizer connections must be used, hence the main switch of a three-wire generator is usually constructed with four blades.

124. Tirrill Regulator.—It has been shown in preceding articles how the voltage of shunt and compound generators may be regulated either by manual adjustment of the rheostat in the shunt field circuit or by the automatic compounding effect of the series field winding. In lighting circuits where steady voltage is of the greatest importance, accurate and automatic regulation of voltage may be obtained by the use of the Tirrill regulator; this device makes it possible to maintain a steady voltage at the generator terminals irrespective of changes in the load or of fluctuations of speed, and also to compensate for line drop by increasing the generator voltage as the load increases.

The regulator maintains the desired voltage by rapidly opening and closing a shunt circuit connected across the terminals of the exciter field rheostat. The field rheostat is so adjusted that when the regulator is disconnected the generator voltage is about 35 per cent. below normal; on closing the regulator circuit the rheostat is short-circuited and the generator voltage rises. When the voltage reaches a predetermined value, the short-circuit around the rheostat is opened and the voltage again falls. The opening and closing of the short-circuit around the rheostat is so rapid that the voltage does not actually follow the changes of the field circuit resistance, but merely tends to do so, with the result that incipient changes of voltage are immediately checked.

An elementary diagram of connections of the regulator is shown in Fig. 184. The opening and closing of the by-pass around the exciter rheostat is accomplished by means of contacts on the armature of a differentially wound relay magnet of U

shape. One winding of the relay magnet is connected directly across the main bus-bars, in series with a current-limiting resistor; the other winding is also connected across the bus-bars, but through a pair of main contacts actuated by the main control magnet. The latter is wound with a potential coil connected directly across the bus-bars, and a current coil (which may or may not be used) whose magnetizing action opposes that of the potential coil.

The operation of the regulator is as follows: If the generator voltage falls, the current through the potential coil of the main control magnet is weakened and the spring closes the main contacts. Current then flows through both windings of the relay

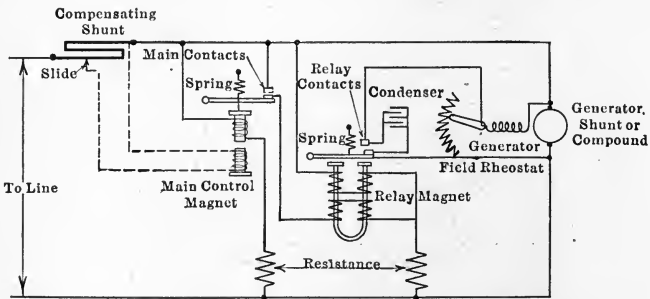

FIG. 184.—Diagram of connections at Tirrill regulator.

magnet which is then demagnetized and the spring closes the relay contacts, thereby short-circuiting the field rheostat. As the voltage rises the armature of the main control magnet is again pulled down, the main contacts are opened, and the relay magnet is again energized, thus again inserting the rheostat in the field circuit. If the current coil of the main control magnet is used, its differential action will cause the voltage to rise higher before the main contacts are opened than would otherwise be the case, thus giving a compounding action. The degree of compounding may be varied by means of the sliding contact on the compensating shunt with which the current coil is in parallel. The condenser shown in the figure is for the purpose of reducing sparking at the relay contacts. A perspective view of a simple regulator built by the General Electric Company is shown in Fig. 185.

When several compound generators of moderate capacity are worked in parallel, a simple regulator may be connected to one of them and the others allowed to "trail." The generator provided with the regulator will take the fluctuations in load, and the load on the others will be equalized through the compound windings. Regulators are also built for controlling the voltages of two or more generators operating in parallel; instead of using a single relay magnet, from two to ten are employed, part of them

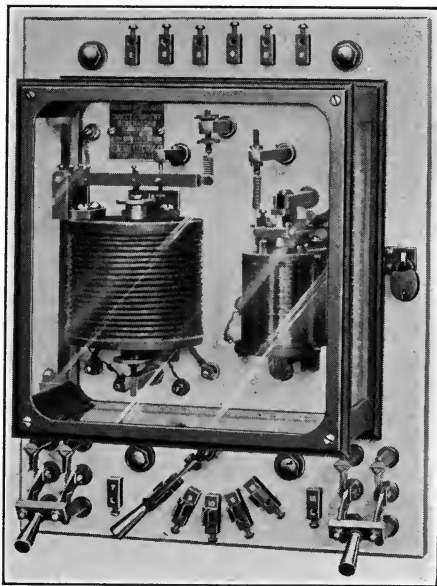

FIG. 185.—Voltage regulator, General Electric Co.

serving to short-circuit sections of the field rheostat of one generator, the others performing a like function for the other machines. Regulators of this kind are suitable for two-wire or three-wire generators with shunt or compound windings, and will compensate for line drops up to 15 per cent.

In the case of very large machines, it is advisable to use separate excitation and to connect the regulators so that they act upon the exciter fields. Of course, in such a case the main control magnet would be actuated by the main bus-bar voltage and line current.

PROBLEMS

1. A 10-pole, 240-volt generator rated at 400 kw. at 200 r.p.m. has a magnetization curve represented by the expression

$$E = \frac{510 \times \text{amp.-turns per pole}}{10750 + \text{amp.-turns per pole}}$$

The armature has a simplex lap winding of 800 conductors, each element having one turn, and the angle of brush lead is 15 deg. The armature (hot) resistance is 0.0033 ohm. The shunt field winding has 550 turns per pole and a (hot) resistance of 10.5 ohms. The coefficient of dispersion is 1.16.

If the field winding is separately excited from 220-volt mains, how much resistance must be put in series with the field winding to develop an open-circuit voltage of 250 volts at 225 r.p.m.?

2. The machine of Problem 1 is operated as a separately excited generator at 200 r.p.m. and with a field excitation sufficient to develop an open-circuit voltage of 240 volts. What will be the terminal voltage when it is delivering 1000 amp.? Solve analytically and graphically.

3. The separately excited generator of Problem 1 is run at a speed of 200 r.p.m. Find the field current required to produce a terminal voltage of 240 volts when the armature current is (a) zero, (b) 800 amp., (c) 1600 amp. Plot a curve showing the relation between field current and armature current, the terminal voltage having a constant value of 240 volts.

4. A series generator has a resistance of 0.2 ohm, and the armature demagnetizing turns per pole at full-load amount to 6 per cent. of the field turns per pole. The open-circuit characteristic may be expressed by Froelich's equation (13), such that at a speed of 1200 r.p.m. an exciting current of 10 amp. develops 120 volts, and an exciting current of 5 amp. develops 80 volts. Find the terminal voltage when the machine is operating as a series generator at 1100 r.p.m., the load current being 8 amp.

5. The machine of Problem 1 is operated as shunt generator at a speed of 200 r.p.m. and with a field resistance such that it gives an open-circuit voltage of 240 volts. Find its terminal voltage when delivering an armature current of 200 amp. How much current is supplied to the load?

6. The machine of Problem 1 has a series winding of 2.5 turns per pole with a total resistance of 0.001 ohm; a shunt around the series field winding reduces the series field current at full load to 1000 amp. If the generator, connected long-shunt, gives a terminal voltage of 240 volts at full load, what will be the open-circuit voltage?

(NOTE.—Neglect the difference between armature current and line current at full load.)

7. Two shunt generators, *A* and *B*, have the same open-circuit voltages and the same full-load current ratings. Their external characteristics may be considered to be straight lines between no-load and full-load conditions, but their percentage voltage regulations (in terms of full-load voltage) are 4 and 6 per cent., respectively. If the current taken by the load is 125 per cent. of the full-load current of either machine, what currents are supplied by *A* and *B*, in per cent. of their respective full-load currents?

CHAPTER VII

MOTORS

125. Service Requirements.—In the industrial application of the motor drive, there are three principal classes of service, characterized by *constant speed*, *adjustable speed*, and *variable speed*. Constant-speed motors, of which the shunt motor is an example, maintain an approximately constant speed at all loads when supplied from constant potential mains, and are used for such purposes as driving line shafting, fans, etc. In the case of adjustable speed motors, the speed can be fixed at any one of a large number of values between a minimum and maximum value, and when so set will remain substantially constant for all loads within the limits of the machine's capacity, the impressed voltage remaining constant throughout; motors of this kind are used, for example, in individual drives for machine tools. Variable-speed motors include those types in which the speed is inherently variable, changing as the load changes, with constant impressed voltage; examples of this class are the series motor and the cumulative compound-wound motor; their speed characteristics make them especially suitable for that class of service in which it is desirable to reduce the speed as the load increases, as in street railway and in hoisting service.

Intelligent operation of motors involves a knowledge of the relations between speed, torque (or turning moment), load (or output), and the electrical and magnetic quantities involved. These relations determine the operating or *mechanical characteristics*, which will be discussed for the different types of motors.

126. Counter E.M.F., Torque and Power.—It has been shown in Chap. II that when a current is sent into the winding of an armature which is under the influence of a magnetic field the individual conductors of the winding are subjected to a lateral thrust and that motion ensues. The immediate effect of this motion is to generate in the conductors an e.m.f. whose direction is

opposite to that of the current. This *counter-generated e.m.f.* is called the “*back e.m.f.*” or the “*counter e.m.f.*”

The effective development of torque in the case of a motor is dependent upon a proper space relation between the field flux and the armature current. If, for instance, the brushes are so set that the axis of the armature current coincides with the axis of field flux, as in Fig. 186*a*, there is no resultant tendency to rotation; but if the axes of armature current and field flux are at right angles to each other, as in Fig. 186*b*, the torque will be a maximum for a given current in the winding.

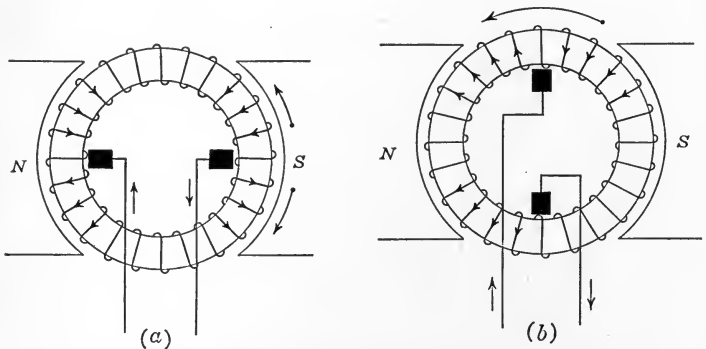

FIG. 186.—Effect of brush position on the torque.

In the case of a separately excited or of a shunt motor, the e.m.f. impressed upon the armature terminals must be consumed in overcoming the back e.m.f. and the ohmic drop due to the resistance of the armature winding and the brush contacts.

$$\therefore E_t = E_a + i_a r_a \tag{1}$$

where

$$E_a = \frac{p}{a} \frac{\Phi Z n}{60 \times 10^8}$$

In the series and long-shunt compound motor, there is an additional drop due to the resistance of the series field winding, hence

$$E_t = E_a + i_a(r_a + r_f) \tag{2}$$

In the case of the short-shunt compound motor the relation is

$$E_t = E_a + i_a r_a + i r_f \tag{3}$$

In general

$$E_t = E_a + i_a r' = \frac{p}{a} \frac{\Phi Z n}{60 \times 10^8} + i_a r' \quad (4)$$

or

$$n = \frac{E_t - i_a r'}{\Phi Z'} \quad (5)$$

where

r' = resistance of armature and circuits in series therewith

and

$$Z' = \frac{p}{a} \frac{Z}{60 \times 10^8} \quad (6)$$

It is also seen that

$$i_a = \frac{E_t - E_a}{r'} \quad (7)$$

an equation which is of importance in connection with the starting of motors, as explained later.

Multiplying equation (4) by i_a , there results

$$E_t i_a = E_a i_a + i_a^2 r' \quad (8)$$

The term $E_t i_a$ represents the power supplied to the armature, and $i_a^2 r'$ is the power dissipated as heat in the ohmic resistance of the armature circuit. It follows, therefore, that $E_a i_a$ is the amount of *mechanical power developed by the armature*. Not all of this developed power is useful power at the shaft or pulley, for some of it is lost in bearing and brush friction, windage, and iron losses.

If P = total mechanical power, in watts, developed in the armature

T = torque in dyne-centimeters $\div 10^7$

$$\therefore P = E_a i_a = 2\pi \frac{n}{60} T \text{ watts} \quad (9)$$

$$\text{or } T = \frac{60}{2\pi n} E_a i_a = \frac{60}{2\pi} Z' \Phi i_a \quad (10)$$

The above unit of torque is inconvenient for practical application; expressing torque in kilogram-meters, pound-feet, and pound-inches, respectively,

$$\begin{aligned}
 T &= \frac{60}{2\pi} \times \frac{10^7}{980 \times 10^3 \times 10^2} Z' \Phi i_a = 0.975 Z' \Phi i_a \text{ kg-m.} \\
 &\equiv \frac{60}{2\pi} \frac{10^7}{980 \times 453.6 \times 30.48} Z' \Phi i_a = 7.05 Z' \Phi i_a \text{ lb-ft.} \\
 &\equiv 84.6 Z' \Phi i_a \text{ lb-in.}
 \end{aligned}
 \quad \left. \vphantom{\begin{aligned} T &= \frac{60}{2\pi} \times \frac{10^7}{980 \times 10^3 \times 10^2} Z' \Phi i_a = 0.975 Z' \Phi i_a \text{ kg-m.} \\ &\equiv \frac{60}{2\pi} \frac{10^7}{980 \times 453.6 \times 30.48} Z' \Phi i_a = 7.05 Z' \Phi i_a \text{ lb-ft.} \\ &\equiv 84.6 Z' \Phi i_a \text{ lb-in.} \end{aligned}} \right\} (11)$$

It is clear from these equations that the torque is dependent only upon the flux and the armature current, and is independent of speed.

127. The Starting of Motors.—If a motor is called upon to start a heavy load from rest, the starting torque may be as large as, or even larger than, the full-load running torque. If the flux at starting has its normal full-load value, the starting current, by equation (11), will then have to be equal to, or perhaps somewhat greater than, its full-load value. Other things equal, the starting current may be smaller the greater the flux. But since $E_a = 0$ when the armature is stationary, it is clear from equation (7) that at the moment of starting $i_a = \frac{E_t}{r'}$, and, therefore, that the normal small running resistance of the armature circuit (r_a or $r_a + r_f$) must be increased during the starting period by the insertion of a starting rheostat in order to limit the flow of current to a reasonable value. Thus, a 10-h.p. 220-volt shunt motor would take an armature current of approximately 40 amperes when carrying its rated load, and would have an armature resistance of about 0.5 ohm. If the full voltage were impressed directly upon the armature, the initial current would be 440 amperes, or more than ten times normal full-load current. To limit the starting current to the full-load value, the resistance that must be put in series with the armature should be

$$\frac{220}{40} - 0.5 = 5 \text{ ohms}$$

The resistance of the starting rheostat is usually so adjusted that the initial current is somewhat greater than that giving full-load torque.

Fig. 187a shows diagrammatically the connections of the starting rheostat in the case of a series motor, and Fig. 187b those of a shunt motor. It should be carefully noted that in Fig. 187b the rheostat is in series with the armature only, so the shunt field

winding receives the full line voltage at all times, including the starting period. Fig. 187c shows an incorrect set of connections, since here the shunt field current is seriously reduced at the

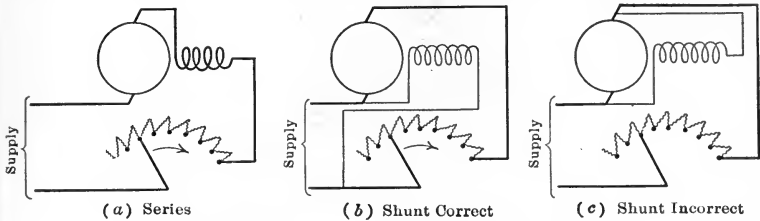

FIG. 187.—Connections of starting rheostats.

start, thereby reducing the flux and also the torque, and, if the motor is unloaded, causing the speed to rise dangerously high.

If an ordinary rheostat of the kind illustrated in Fig. 187 were used in commercial installations, there would be danger of burn-

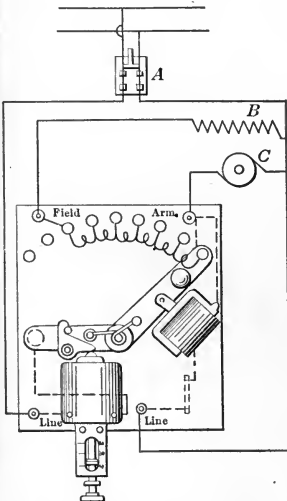

FIG. 188.—Diagram of connections of starting rheostat having no-voltage and overload release.

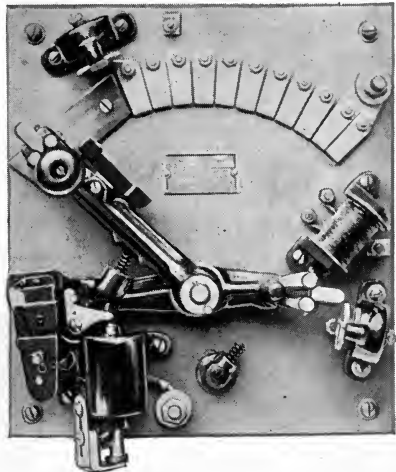

FIG. 189.—Motor starting rheostat with no-voltage and overload release.

ing out the armature if, after an interruption of the service and the consequent stopping of the motor, the voltage should again be applied to the supply line; for in that case the full line voltage

would be thrown directly across the low resistance of the armature (or armature and series field), resulting in a very heavy current. For this reason most motor starting rheostats are provided with a "no-voltage release" which automatically restores the starting lever of the rheostat to the starting position when the line voltage is removed; quite frequently there is also an "overload release," which opens the circuit and automatically cuts in the starting resistance if the current becomes excessive for any reason. The connections of such a rheostat are shown in Fig. 188, and Fig. 189 illustrates a starting rheostat of this type made by the Ward Leonard Company.

It is seen from equation (5) that if the flux Φ is reduced to a small value while the e.m.f. impressed upon the armature remains constant, the speed will rise to a dangerously high value. In other words, the motor will "run away" and may wreck itself. This contingency may arise in the case of a shunt motor if the field circuit is opened, as by a broken wire or loose connection, and in the series motor by an accidental short circuiting of the terminals of the series winding. This behavior is due to the tendency of any motor to run at such a speed that the back e.m.f. shall be nearly equal to the impressed e.m.f., the lowering of the flux demanding an increased speed.

128. Characteristics of the Separately-Excited Motor.—

(a) *Speed Characteristics.*—Let it be assumed that both the impressed e.m.f., E_t , and the field exciting current are constant. It follows from the speed equation

$$n = \frac{E_t - i_a r_a}{\Phi Z'}$$

that were it not for the demagnetizing action of the armature current, the denominator of the fraction would be constant and the speed would decrease slightly and uniformly with increasing values of i_a , as in Fig. 190. This assumes that r_a is constant; in other words, that the temperature of the armature is maintained at its normal running value. The separately excited motor with constant excitation is, therefore, inherently self-regulating as regards speed. Both equation (5) and Fig. 190 indicate that if $i_a = 0$, $n = \frac{E_t}{\Phi Z'}$. Actually, if $i_a = 0$, there is no torque and no rotation. When the motor is "running free"

(that is, unloaded), there is still some current through its armature since sufficient power must be supplied by the line to overcome internal losses due to windage, friction, hysteresis and eddy currents. The minimum value of armature current is indicated by the point *A* in the figure. The speed $n = \frac{E_t}{\Phi Z'}$ may be called the ideal zero-load speed; it is the speed that would be reached if there were no losses, in which case also, $E_a = E_t$ and $i_a = 0$.

It is obvious that the speed may be varied through wide limits by varying either Φ or E_t , or both of them. Thus, the speed can be raised by reducing Φ or by increasing E_t . However, the possible range of speed due to the adjustment of the excitation is rather restricted, unless special devices are used, because there are limits to the field strength above or below which there are serious commutation difficulties. Variation of E_t gives little or no trouble so far

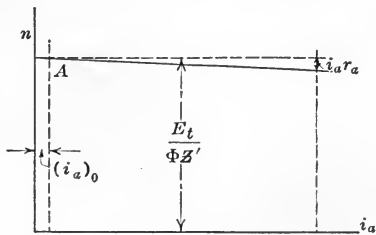

FIG. 190.—Approximate speed characteristic of separately excited motor.

as commutation is concerned, provided the flux is originally adjusted to about its normal value unless, indeed, E_t is raised to too great an extent. The fact that the field excitation and the armature impressed e.m.f. are independently variable in the separately excited motor gives to this type its chief advantage.

(b) *Effect of Armature Reaction.*—The form of the speed equation shows at a glance that the effect of armature reaction, since it reduces Φ , will be to raise the speed, thereby partially neutralizing the slowing-down effect of armature resistance and improving the speed regulation. The armature of a motor may therefore be designed magnetically more powerful than the armature of an otherwise identical machine intended for use as a generator.

The curve showing the relation between speed and armature current can be constructed in the following manner:

Let $O'G$, Fig. 191, be the magnetization curve of the machine, abscissas (drawn downward from O) representing ampere-turns per pair of poles ($= n_f i_f$) and ordinates (drawn to the left of O)

representing values of $\Phi Z'$. Select any convenient scale of armature current along OA , and a scale to represent the impressed voltage along OV . Assume that the field excitation is constant and equal to OF_0 , and that the voltage impressed upon the armature is likewise constant and equal to $OE = E_t$.

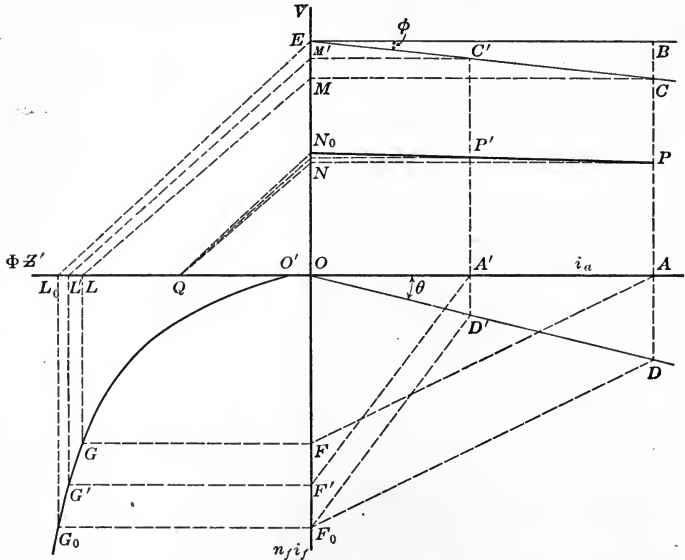

FIG. 191.—Construction of speed characteristic of separately excited motor.

Draw a straight line EC through the point E so that $\tan \phi = r_a$, to the scale of the figure; then for any value of i_a , such as OA , the intercept on the ordinate at A between EC and EB will be $BC = i_a r_a =$ ohmic drop in the armature. The back e.m.f. is then

$$E_a = E_t - i_a r_a = AB - BC = AC$$

Similarly, draw OD making an angle θ with OA , such that $\tan \theta = \frac{\alpha Z}{180a}$; then when $i_a = OA$, $AD = \frac{\alpha Z}{180a} i_a =$ demagnetizing ampere-turns per pair of poles.

If the armature were currentless ($i_a = 0$) as in the ideal no-load condition, the value of $\Phi Z'$ would be $F_0 G_0 = OL_0$, and the ideal no-load speed is then

$$n_0 = \frac{E_t}{\Phi Z'} = \frac{OE}{OL_0}$$

At any other load, as when $i_a = OA$, the demagnetizing effect is given by AD ; joining D with F_0 , and drawing AF parallel to DF_0 the net excitation is reduced to OF and $\Phi Z'$ becomes $FG = OL$; at the same time the back e.m.f. is $AC = OM$, hence the speed is

$$n = \frac{E_t - i_a r_a}{\Phi Z'} = \frac{OM}{OL}$$

In this way values of speed can be computed for various values of i_a and the results plotted to obtain the desired curve, N_0P . But the diagram lends itself readily to a complete graphical solution, as follows:

Select any convenient point Q on the $\Phi Z'$ axis, and draw QN_0 parallel to L_0E ; then

$$n_0 = \frac{OE}{OL_0} = \frac{ON_0}{OQ}$$

Similarly, join L and M and draw QN parallel to LM .

$$\therefore n = \frac{OM}{OL} = \frac{ON}{OQ}$$

Since OQ is constant, it follows that ON_0 and ON are respectively proportional to n_0 and n , and may be made *equal* to the speed by a suitable choice of scale. Projecting N across to P , the latter being on the ordinate through A , P will be a point on the required curve. In precisely the same manner, P' is a point corresponding to $i_a = OA'$. It is clear that the speed curve cannot be exactly straight because of the curvature of the magnetization curve.

(c) *The Torque Curve.*—From equation (11), the torque is

$$T = 7.05 \Phi Z' i_a \text{ pound-feet}$$

Referring to Fig. 191, this becomes

$$T = 7.05 FG.OA = 7.05 OL.OA$$

when $i_a = OA$. This may be written

$$\frac{T}{OA} = \frac{OL}{\text{constant}}$$

which equation suggests the following construction for the curve showing the relation between the armature current and the torque:

In Fig. 192 draw the axes of coordinates, the $\Phi Z'$ curve, and the line OD just as in Fig. 191. Proceed as before to locate points G and L . Select any convenient constant length OR ,

draw LR , and then draw OP perpendicular to LR (using the semi-circle on OR as a construction line) until it intersects the ordinate through A in the point P . By construction

$$\frac{AP}{OA} = \frac{OL}{OR} = \frac{OL}{\text{constant}}$$

hence AP is proportional to the torque, or may be made equal to the torque by a suitable choice of the length OR , and P is then a point on the desired torque curve. The torque curve is slightly concave downward, but to all intents and purposes it is a straight line through the origin, since Φ is almost constant for all values of i_a within the working range.

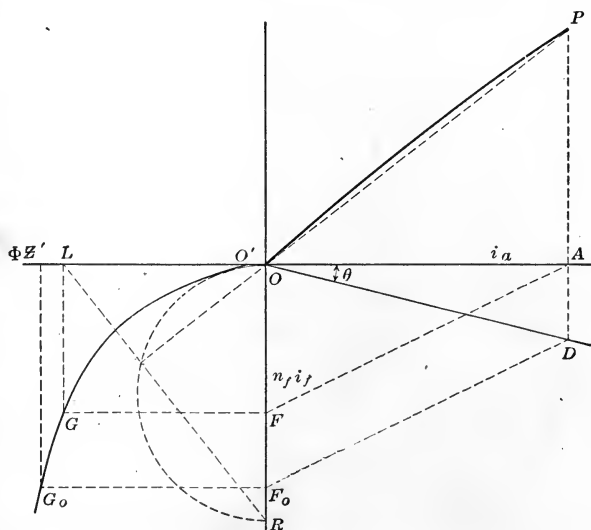

FIG. 192.—Construction of torque characteristic of separately excited motor.

129. Characteristics of the Shunt Motor.—

SPEED AND TORQUE CHARACTERISTICS.—A plain shunt motor operated on constant potential mains, and having fixed field resistance, differs in no way from a separately excited machine with constant impressed e.m.f. and constant excitation. The determination of its operating characteristics is, therefore, to be carried out in exactly the same manner as described in the preceding article.

The chief point of difference between the shunt and the separately excited motor is that in the former the field excitation and the impressed e.m.f. are not independently variable, as in the latter. The possible range of speed variation is therefore less in the shunt motor than it is in the separately excited motor.

130. Characteristics of the Series Motor.—

(a) *Speed Characteristic.*—Inspection of the general equation for the speed

$$n = \frac{E_t - i_a (r_a + r_f)}{\Phi Z'}$$

shows that the speed of the series motor must decrease quite rapidly with increasing load for the reason that Φ increases with increasing i_a . In other words, while the numerator of the fraction decreases, the denominator increases. Theoretically, if $i_a = 0$, $\Phi = 0$, hence at no load the speed would be infinite; practically, while the flux does not become zero because of residual magnetism, it still becomes so small that the speed reaches a dangerously high value, assuming that E_t remains constant. For this reason, a series motor must always be so installed as to be positively connected to its load, by gearing or direct connection, never by belting, and the minimum load must be great enough to keep the speed within safe limits; such is the case, for instance, in railway motors, hoists, rolling mills, etc.

Assuming that the motor is to be operated on constant potential mains, its speed characteristic can be determined by a modification of the methods described in the case of the separately excited motor, as follows:

Let $O'G$, Fig. 193, be the curve which gives the relation between $\Phi Z'$ and the exciting current (i_a). Let OE represent to scale the constant impressed voltage, E_t , and draw EC so that $\tan \varphi = (r_a + r_f)$, to the scale of the figure; then BC will represent to the same scale the internal ohmic drop corresponding to $i_a = OA$, and AC will be the back e.m.f. Also, draw OD so that $\tan \theta = \frac{v\alpha Z' 1}{180a n_f}$ where n_f is the number of field turns per pair of poles; then AD will be the demagnetizing effect expressed in equivalent amperes instead of in ampere-turns per pair of poles.

When the armature current is $i_a = OA$, the field excitation (in

amperes) is $OF = OA$, the point F being found by drawing AF at an angle of 45 deg. with the horizontal. The demagnetizing effect is $AD = FH$, hence the net excitation is OH and the corresponding value of $\Phi Z'$ is $HK = OL$.

$$\therefore n = \frac{E_t - i_a (r_a + r_f)}{\Phi Z'} = \frac{AC}{HK} = \frac{OM}{OL}$$

Selecting a point Q on the $\Phi Z'$ axis such that OQ is constant, and drawing QN parallel to LM ,

$$n = \frac{OM}{OL} = \frac{ON}{OQ}$$

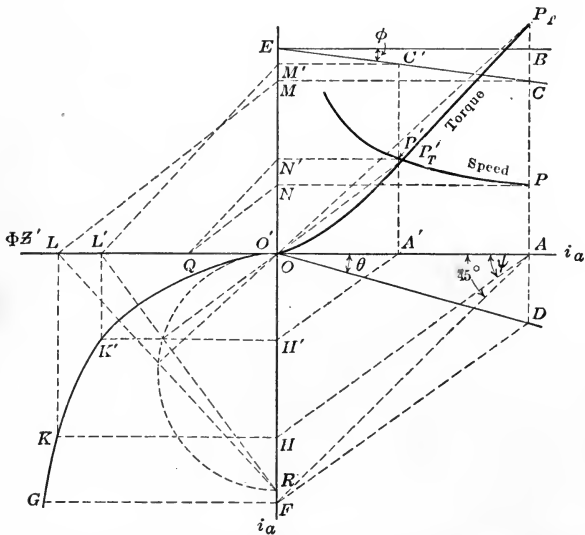

FIG. 193.—Construction of speed and torque characteristics of series motor.

hence ON is proportional to the speed. Projecting N upon the ordinate at A , the resulting point P is a point on the speed-current curve.

Since

$$FH = AD = \frac{v\alpha Z}{180an_f} i_a = i_a \tan \theta$$

$$OH = OF - FH = i_a - i_a \tan \theta$$

and

$$\tan \psi = \frac{OH}{OA} = 1 - \tan \theta = \text{constant}$$

it follows that for any other current, as $i_a = OA'$, it is only necessary to draw $A'H'$ parallel to AH in the process of locating P' .

(b) *The Torque Characteristic.*—As before, the torque is

$$T = 7.05 \Phi Z i_a = 7.05 OL.OA \text{ pound-feet}$$

when $i_a = OA$.

Selecting a point R such that $OR = \text{constant}$, and drawing OP perpendicular to LR ,

$$\frac{AP_T}{OA} = \frac{OL}{OR}$$

whence AP_T is proportional to the torque, and P_T is a point on the torque-current curve.

It will be observed that the torque curve of a series motor deviates considerably from the linear form due to the fact that the flux varies with the current. If the magnetization curve were a straight line, that is, Φ proportional to i_a , the torque would be proportional to $(i_a)^2$, and the curve would be a parabola; actually it is a curve of higher order, lying between the linear and parabolic curves.

Lines such as OP_T can readily be drawn perpendicular to LR by constructing a semicircle on OR as a diameter and drawing a line through O and the point where LR cuts the circle.

The torque curves discussed in connection with the separately excited, shunt and series motors refer to the total developed torque, as given by equation (11). The actual torque at the pulley that would be measured by a brake test is less than the total torque by an amount which corresponds to the torque required to overcome internal friction and iron losses. The curve of useful torque may be obtained from that of total torque by subtracting from the ordinates of the latter the "lost torque"; the useful torque passes through zero value when i_a has an appreciable value (see Fig. 209).

131. Characteristics of the Compound Wound Motor.—

(a) *General.*—If the shunt and series windings of a compound wound (long shunt) machine are so connected that their magnetizing effects cooperate, or are *cumulative*, when the machine is used as a generator, then, if the machine is used as a motor, the two windings will oppose each other, resulting in a *differential* effect. This is illustrated diagrammatically in Fig. 194. If the machine

is designed to over-compound as a generator, the differential motor action will be considerable, resulting in a decided decrease of flux under load conditions, and hence a speed higher than would obtain without the series winding. In general, the case is similar to that of a shunt motor with exaggerated armature demagnetizing effect.

In the same way a differentially wound generator, having a drooping e.m.f. characteristic when driven at constant speed, becomes a cumulative-compound motor with a drooping speed characteristic when supplied with constant terminal voltage.

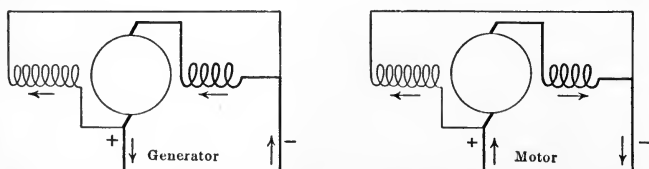

FIG. 194.—Relative directions of shunt and series exciting current in compound machine.

(b) Construction of Speed Characteristic.—

(I) Differential Compounding.

The only difference between this case and the one discussed in connection with Fig. 191, is that now

$$\tan \varphi = r_a + r_f$$

and

$$\tan \theta = \nu \frac{\alpha Z}{180a} + n_f$$

assuming that the resistance of the shunt field winding is constant. The construction has been carried out in Fig. 195, from which it appears that if n_f is sufficiently large, the speed rises with increasing load. It is clear that there is a particular value of θ for which the speed will be the same at full load as at no load, but that it cannot be made absolutely constant at all loads (in the absence of special regulating devices) because of the curvature of the magnetization curve $O'G$.

The torque curve is also shown in Fig. 195, the fixed point R being used in its construction. The curve is concave downward, due to the fact that the flux decreases with increasing current.

(II) *Cumulative Compounding*

Here,

$$\tan \varphi = r_a + r_f$$

and

$$\tan \theta = \nu \frac{\alpha Z}{180a} - n_f$$

therefore, the line OD must be drawn *above* OA instead of below it; otherwise the construction shown in Fig. 196 is the same as in the previous cases for both the speed and torque curves. The speed now falls considerably with increasing load, and the torque curve is concave upward. The cumulative compound motor has characteristics which are intermediate between those of the shunt and series motors. It differs from the latter especially in this, that its speed rises to a definite limit when full load is suddenly thrown off, instead of running away.

132. Counter E.M.F.—The Reversing Motor.—The existence of the counter-generated or back e.m.f. can be shown in a striking

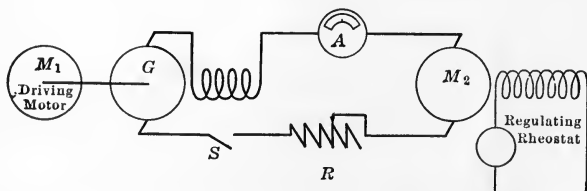

FIG. 197.—Connections for the experiment of the reversing motor.

manner by the arrangement shown diagrammatically in Fig. 197. A series generator, G , is driven at constant speed by a suitable motor, M_1 , and the generator is electrically connected through the switch S and the regulating resistance R to the armature of an unloaded and separately excited motor, M_2 . The field of M_2 is excited by a constant current supplied from any convenient source.

On closing the switch S , the series generator will build up both e.m.f. and current, provided the resistance of the circuit is below the critical value. At the same time, the speed of M_2 will rise and its back e.m.f. will rise nearly proportionally, so that the active e.m.f. in the circuit, available for producing current, is the difference between the e.m.fs. of generator G and of motor M_2 .

The current therefore falls after rising to a certain value and with it the generated e.m.f. of G decreases. Meanwhile, the speed of M_2 continues to rise because of its acquired momentum, its back e.m.f. overpowers the generated e.m.f. of G , the current in the circuit reverses (as may be shown by the two-way ammeter A), and M_2 momentarily becomes a generator tending to drive G as a motor in opposition to motor M_1 . But as M_2 has no driving power other than its energy of rotation, it very quickly comes to rest. Since the current through the circuit has been reversed, the residual magnetism of G also reverses, consequently as soon as M_2 has come to rest G begins to build up again, but with polarity opposite to that in the first instance. Motor M_2 then speeds up again in the reverse direction until its back e.m.f. overpowers the generator, it again stops, and the entire cycle of changes is repeated, over and over again.

The function of the resistance R is simply to prevent the current from reaching excessive values, and its magnitude will depend upon the machines used in the experiment. The rate at which motor M_2 will build up in speed depends upon the moment of inertia of its armature and upon the torque, the latter in turn depending upon the magnitude of the exciting current of M_2 . The larger the excitation of M_2 , the greater will be the torque for a given armature current, and the more rapid will be the process of picking up speed; moreover, the greater the excitation, the less will be the speed to produce a given back e.m.f. Finally, therefore, it will be seen that the reversals of M_2 will be more and more rapid, the greater the excitation of M_2 .

The above reasoning will serve to explain why a series generator cannot be used to charge a storage battery. For as the charging proceeds the counter e.m.f. of the battery rises, hence reducing the effective e.m.f. in the circuit; the current, therefore, falls and as it decreases, the e.m.f. of the generator also decreases. The current will therefore continue to fall off until it becomes zero, and then the battery discharges through the generator, tending to make it run backward as a motor.

133. Starting of Differentially Wound Motors.—Differentially wound compound motors are seldom used in practice for the reason that in most cases the slightly drooping speed characteristic of the plain shunt motor meets the requirements of constant

speed to a sufficient extent. Moreover, the differentially wound motor is subject to "racing" in case of heavy overload, due to the considerable reduction of field flux caused by the large current in the series field winding. Such motors are also liable to start up in the wrong direction on throwing the handle of the starting rheostat to the first notch; for the high inductance of the shunt winding, due to the large number of turns, may so impede the rise of the shunt field current that the current in the series winding, which builds up much more rapidly because of the small inductance of that circuit, may overpower the magnetizing effect

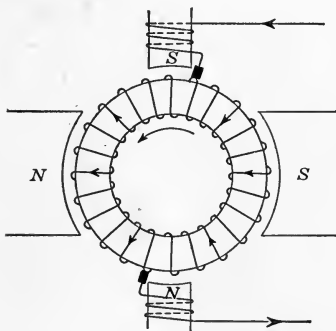

FIG. 198.—Differential effect in interpole motor due to backward shift of brushes.

of the shunt winding, and so reverse the flux and the direction of rotation. In that case the motor, if unloaded, will rapidly speed up in the wrong direction, thereby developing a considerable counter e.m.f. and so reducing the current flow and the torque; the acquired momentum of the armature may even for a brief interval cause the machine to become a generator and send current back to the line. In the meantime the shunt field current has been building up, and when the armature finally stops

because of reduced torque or the dissipation of its energy of rotation, a heavy flow of current through the armature and series winding will result because there is now no counter e.m.f. The machine will then start up in the right direction, but if the initial current flow is sufficiently great the series excitation may overpower that of the shunt winding, and so bring about another reversal of rotation. This process may go on indefinitely unless the design constants of the machine are such that the successive impulses are damped out, that is, do not synchronize with the natural period of oscillation of the armature.

A similar state of affairs may arise in the case of shunt motors provided with interpoles if the brushes are not properly placed. Normally the axis of commutation coincides with the axis of the interpoles, but if the brushes are accidentally shifted backward,

against the direction of rotation, as in Fig. 198, the interpoles will produce a component of flux in opposition to that of the main poles, and so convert the machine into one having the characteristics of a differentially wound motor.

134. Regulation of Speed of Shunt Motors.—Inspection of the fundamental equation for the speed of a motor

$$n = \frac{E_t - i_a r'}{\Phi Z'}$$

reveals the fact that there are three principal methods for regulating the speed, namely, *rheostatic control*, by varying the resistance r' , which includes the armature resistance r_a ; *voltage control*, by varying the impressed voltage E_t ; and *field control* by varying Φ . A fourth method occasionally used involves changing Z' by using an armature having two windings and two commutators which may be connected either in series or in parallel.

(a) *Rheostatic Control.*—In this method the effective resistance of the armature is increased by connecting in series with it (but

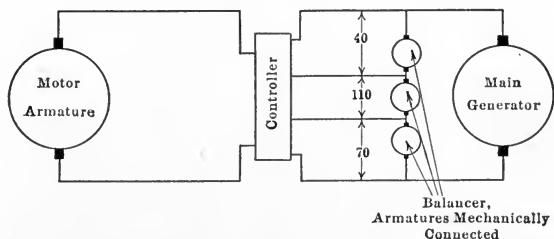

FIG. 199.—Speed regulation of motor by means of voltage control.

not in the main line or field circuit) a variable resistance. This has the effect of imparting a pronounced droop to the speed characteristic (Figs. 190 and 191), the downward slope of the characteristic being proportional to the combined resistance of the armature winding and external resistor. A motor used in this way has poor speed regulation, that is, the speed will fluctuate between rather wide limits as the load changes; moreover, the method is inefficient because of the loss of power due to the flow of the armature current through the external resistor. It is not to be recommended in commercial installations, but is frequently convenient in laboratory investigations and in special tests.

(b) *Voltage Control*.—Subdividing the voltage of the main generator or bus-bars by means of a balancer set, as in Fig. 199, makes it possible to impress upon the armature of the motor a number of different voltages, to each of which there will correspond a definite speed characteristic such as is illustrated in Fig. 191. For any given impressed voltage the speed will be substantially constant and will be approximately proportional to the impressed voltage. The variation in speed between full-load and no-load with normal voltage will usually be between 2 and 10 per cent., the smaller limit holding for large motors, the larger limit for small motors. It should be understood that the motor connections are such that the voltage impressed on the shunt field winding is not changed when the armature is switched from one circuit to another, in order that the field flux may remain sub-

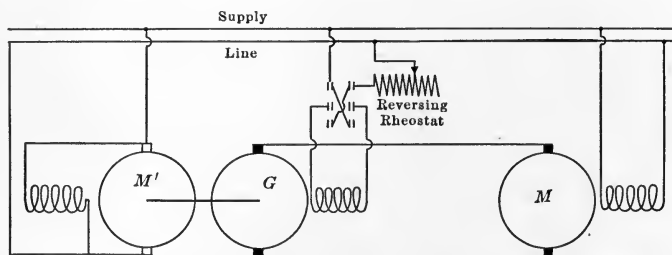

FIG. 200.—Diagram of connections of Ward Leonard system of speed control.

stantially constant. The armature connections are changed by means of a special controller, somewhat resembling an ordinary railway motor controller.

With the arrangement indicated in Fig. 199 it is possible to impress six different voltages upon the motor, namely, 40, 70, 110, 150, 180 or 220 volts, giving six different speeds. Intermediate speeds may then be secured by adjusting the flux by means of a rheostat in series with the shunt field winding. This method is extensively used for driving machine tools, such as lathes, boring mills, etc. It has the disadvantage of requiring a considerable investment in copper due to the extra wires of the distributing circuits.

Where uniform gradation of speed in either direction is required, as in the operation of the turrets of battleships or in steering by

electrically controlled rudders, the Ward Leonard system may be used. The motor M , Fig. 200, whose speed is to be regulated, is separately excited from the main supply lines and its armature is supplied from an auxiliary generator G , the latter being driven at constant speed by a shunt motor M' which takes its power from the line; instead of driving the generator G by a motor, any other form of prime mover may be used. The field of the generator is excited from the constant voltage supply line, and may be adjusted from zero to a maximum, in either direction, by means of a reversing field rheostat; in this way it is possible to obtain a

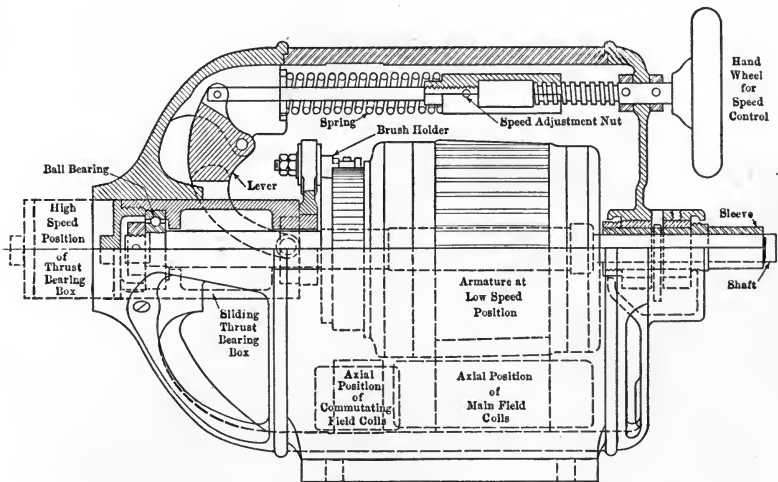

FIG. 201.—Sectional view of Lincoln adjustable speed motor.

smooth variation of the voltage impressed upon the motor. This method is very effective, but is naturally expensive because of the auxiliary motor-generator set.

(c) *Field Control.*—The simplest and cheapest method of regulating the speed of a shunt motor is that in which the flux is varied by means of a rheostat in the shunt field circuit. If the machine operates normally with a nearly saturated magnetic circuit, all resistance of the rheostat being cut out, the speed may be approximately doubled by weakening the field current; beyond this point the field intensity at the pole tips becomes so weakened by armature reaction, especially under load conditions,

that commutation is seriously interfered with. Consequently this method is limited to those cases in which a very moderate range of speed will suffice.

The interpole motor affords means whereby a wide range of speed is made possible, a ratio of maximum to minimum speed of 5 or 6 to 1 being fairly common. The principle of the interpole motor involves the neutralization of the armature reaction of the motor by placing auxiliary poles in the axis of commutation and exciting them by the same current that flows through the arma-

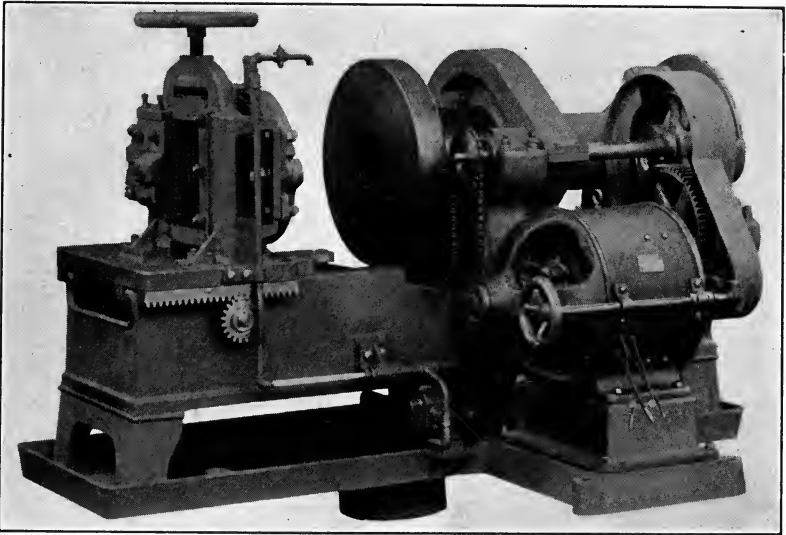

FIG. 202.—Lincoln adjustable speed motor driving pipe cutting machine.

ture, the winding of the auxiliary poles being so designed that the m.m.f. of the armature is either exactly balanced or else slightly overcompensated. In this way the main field may be varied through a wide range without producing sparking, the interpoles always producing a field of the proper strength to reverse the current in the coils undergoing commutation. Interpole motors are used to a very large extent where variable speed is a necessity, as in machine tool operation. They are generally provided with a controller which serves not only to start the motor, and to reverse its direction, but also to vary its speed as desired.

The methods thus far described effect the variation of speed by adjustment of the electrical circuits of the machine. But the flux and, therefore, the speed can be varied by mechanical devices which change the length of the air-gap. In the Lincoln adjustable speed motor, shown in section in Fig. 201, the armature core is conical, so that as the armature is moved sideways by means of the handwheel the effective length of air-gap may be increased or decreased at will. A range of speed of 10 to 1 is readily obtained in the smaller sizes. Commutation difficulties at high speeds (and weak field) are avoided by using interpoles. Fig. 202 shows a similar machine made by the Reliance Electric

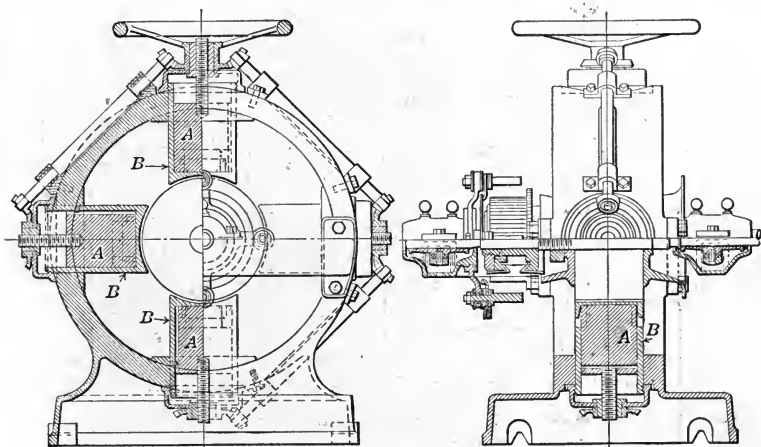

FIG. 203.—Stow multi-speed motor.

and Engineering Co., the motor here being geared to a pipe cutting machine.

Speed variation is obtained in the Stow multi-speed motor by plungers which are moved in and out of the hollow pole cores by means of a handwheel and bevel gears, as shown in Fig. 203. The speed is increased by drawing the plungers away from the armature, thereby weakening the field; the thin shell of iron thus left at the pole tips becomes saturated, and the commutating field is therefore sufficiently intense to prevent sparking at the upper limit of the speed.

135. Applications of the Series Motor.—The rapid drop in speed of the series motor as its load is increased makes this type

of machine especially valuable for traction purposes, as in street railways and hoisting service, and in rolling mills. In railway work, for example, motors having a constant speed character-

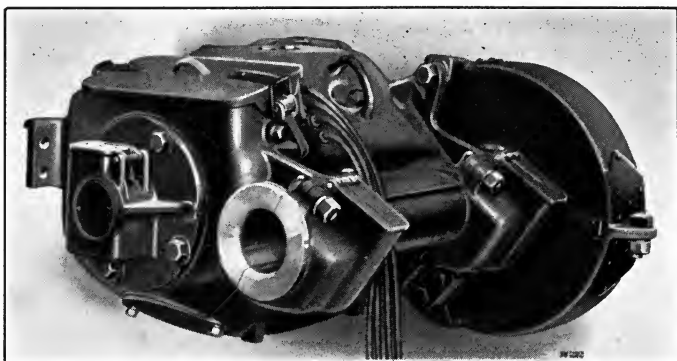

FIG. 204.—Box frame railway motor, forced ventilation. (General Electric Co.)

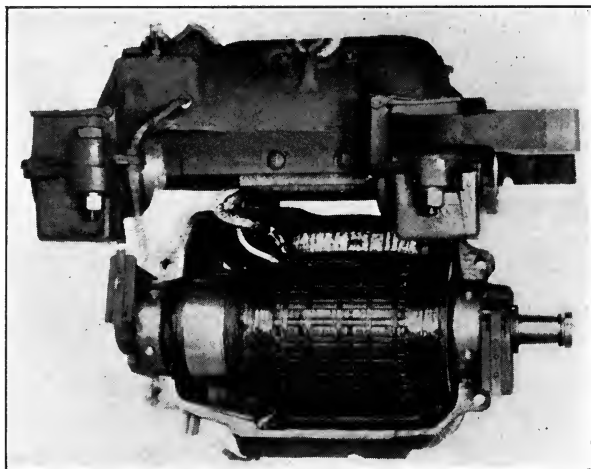

FIG. 205.—Split frame commutating pole railway motor, Westinghouse Elec. & Mfg. Co.

istic like the shunt motor are seldom used for the reason that the current taken by such a motor in going up a steep grade is excessive; for since the speed of such a motor will remain substantially constant if the impressed voltage is constant, the additional power

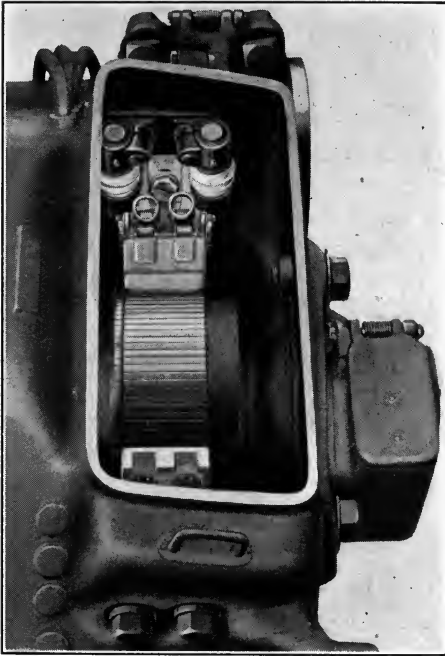

FIG. 206.—Commutator and brushes of motor of Fig. 204.

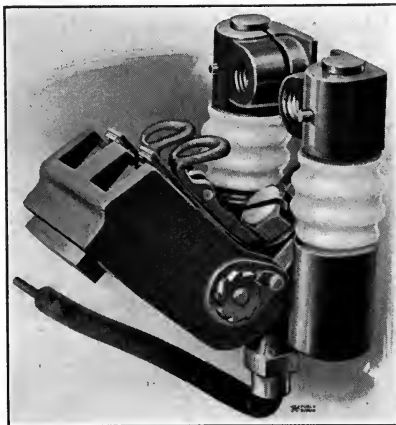

FIG. 207.—Brush holders of motor of Fig. 204.

required to climb the grade demands a proportionally increased current. The series motor, on the other hand, will slow down as the load increases, automatically preventing an excessive load, and, to a certain extent, tending to maintain a constant load on the system; at the same time it develops a torque more than proportional to the current, while in the shunt motor the torque increases less than proportionately to the current.

Series motors for railway, automobile, hoisting and rolling mill service are generally of the totally enclosed type. In rail-

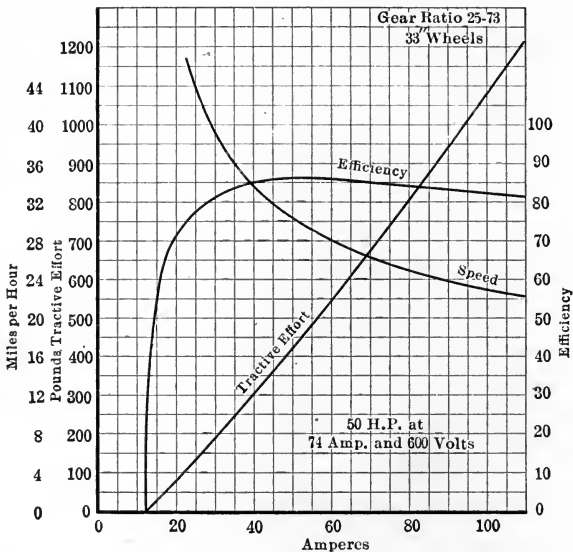

FIG. 208.—Characteristic curves of motor of Fig. 204. (General Electric Co.)

way and automobile service, in particular, the motors must be waterproof and of rugged construction to withstand the rough usage to which they are subjected by reason of poor roadbed and improper handling of the starting controller. A too rapid cutting out of the starting resistance results in very heavy current, excessive torque, and a wracking of the armature winding.

Fig. 204 illustrates a recent type of railway motor made by the General Electric Company. It is of the box frame, commutating pole type with forced ventilation, the inlet and outlet for

the cooling air being at the pinion end of the frame. In the box frame type the armature may be removed from the frame through the opening at the commutator end. Fig. 205 shows a split frame commutating pole motor made by the Westinghouse Electric and Manufacturing Company. Figs. 206 and 207 show the commutator and brush rigging of the motor illustrated

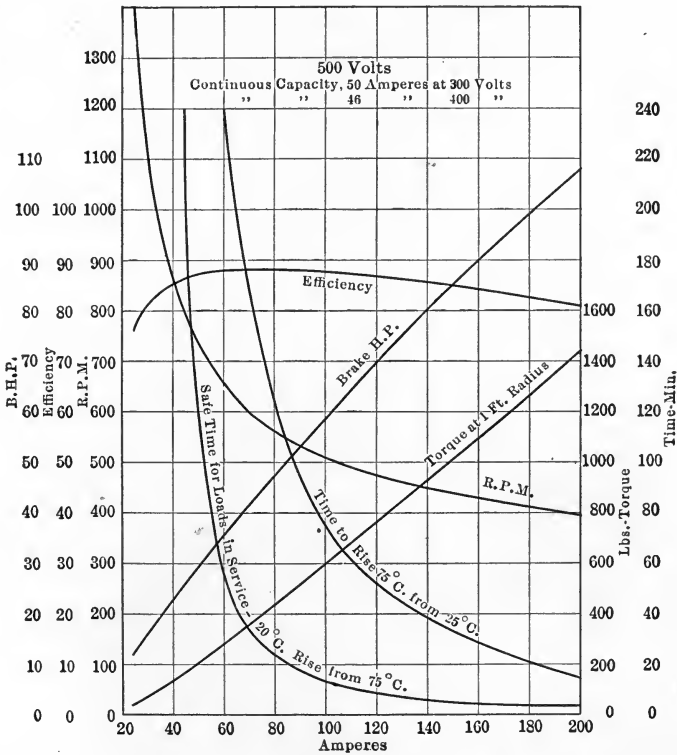

FIG. 20.9—Characteristic curves of motor of Fig. 205. (Westinghouse Elec. & Mfg. Co.)

in Fig. 204. The characteristic curves of the motor of Fig. 204 are shown in Fig. 208; those of Fig. 205 in Fig. 209.

136. Cycle of Operation of Railway Motors.—The horse-power rating of a railway motor has little significance in determining its suitability for a particular equipment; the nominal horse-power rating is defined as that load which the motor will carry for one

hour without exceeding a temperature rise of 90° C. at the commutator and 75° C. at any other normally accessible part, the motor being tested on a stand with an impressed e.m.f. of rated value, and the motor covers being arranged to secure maximum ventilation without external blower.¹ In any given case the motors must be so selected that they will not overheat and the heating depends in part upon the average value of the square of the current taken throughout the whole of the working period, including stops. The current has its largest value during the starting or acceleration period, hence the heating is largely dependent upon the number of stops in any given schedule.

When the car—or train—is started, the resistance in series

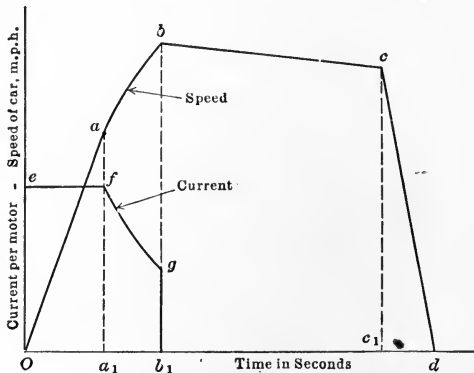

FIG. 210.—Speed-time and current-time curves of railway motor.

with the motors should be cut out step by step in such a manner that the current through each motor remains practically constant until all the resistance is out of the circuit. The torque per motor will then be constant, hence the draw-bar pull and the resulting acceleration will also be constant, and the speed of the car will increase uniformly, as indicated by the line Oa , Fig. 210. When the resistance is all out, the speed will continue to increase, but at a steadily decreasing rate, as represented by the curved line ab , and during this interval the current will decrease from the initial constant value Oe in the manner indicated by curve fg . The cause of the decreasing current is the increasing counter e.m.f. due to the rising speed. After the time Ob_1 , the current is

¹ See 1914 Standardization Rules, A.I.E.E.

shut off, and the car allowed to coast, the speed accordingly falling in the manner shown by line bc . The brakes are then applied and the speed rapidly falls from cc_1 to zero. The broken line $Oabcd$ is called a *speed-time* curve, and its area is proportional to the distance traveled by the car in the time Od .

The slope of the line Oa is the acceleration of the car; the value ordinarily used varies from 1 to 2 miles per hour per second, and this in turn determines the draw-bar pull, torque and current when the weight of the car, gear ratio and type of motor are known.

137. Series-parallel Control.—In cars having a two-motor equipment the motors and starting resistance are at first all connected in series, and after the resistance has been cut out, the connections are quickly changed so that the motors themselves are in parallel with a resistance between them and the line; this resistance is then cut out, so that finally the motors are in parallel directly across the full voltage of the line. The elementary diagram of connections is shown in Fig. 211. In four-motor equipments, the motors are usually connected in parallel in pairs, and the two pairs are then connected in series-parallel just as though each pair were a single machine.

The series-parallel control is a much more economical method than if each motor had its own starting rheostat, or than if the motors were permanently in parallel with a single resistance for starting purposes. For example, assume a two-motor equipment with the following data:

E = line or trolley voltage

I = current per motor during acceleration period

r = resistance of each motor

t = duration of acceleration period, in seconds.

At the moment of starting, the motors being in series (Fig. 211a), the starting rheostat must have a resistance of R_1 ohms such that

$$I = \frac{E}{R_1 + 2r}$$

or

$$R_1 = \frac{E}{I} - 2r$$

The loss in the rheostat at the first instant is then at the rate of I^2R_1 watts; but as the motor speeds up at a uniform rate under the assumption of constant current, the counter e.m.f. also increases uniformly, and in order to keep the current constant the resistance must be cut out at a uniform rate. All of the resistance should be out of circuit in a time $\frac{t}{2}$ seconds, and the motors then switched to the parallel position (Fig. 211b). During the first half of the acceleration period the energy lost in the rheostat is then

$$W_{R_1} = \frac{1}{2}I^2R_1\frac{t}{2} = \frac{1}{4}I^2R_1t \text{ watt-seconds.}$$

At the instant when all of the resistance R_1 is out of circuit, each motor receives half of the line voltage and this condition may be maintained efficiently if it is desired to continue running at reduced speed. But if the speed is to be increased at the original rate, as in Fig. 210, the motors must be put in parallel and a new resistance R_2 inserted between them and the line. In order that there may be no break in the smoothness of the acceleration, each motor must continue to take I amperes, and at the first instant after the transition has been made the resistance R_2 must consume $E/2$ volts since the remaining $E/2$ volts are taken up by the motors. The resistance R_2 must then have such a value that

$$R_2 = \frac{\frac{1}{2}E}{2I} = \frac{E}{4I} \text{ ohms}$$

and the energy lost in the rheostat during the second half of the acceleration period will be

$$W_{R_2} = \frac{1}{2}(2I)^2R_2\frac{t}{2} = I^2R_2t \text{ watt-seconds.}$$

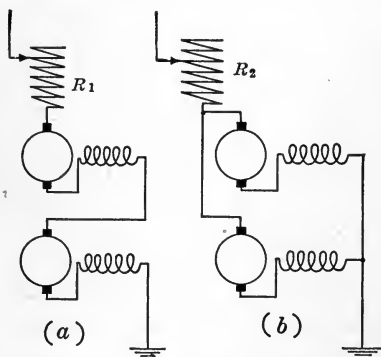

FIG. 211.—Elementary diagram of connections, series-parallel control.

The total loss in the rheostat is then

$$W = W_{R_1} + W_{R_2} = I^2 t \left(\frac{R_1}{4} + R_2 \right) = \frac{1}{2} I^2 t \left(\frac{E}{I} - r \right) \text{ watt-seconds.}$$

If, now, the motors had been originally in parallel, as in Fig. 211*b*, with a resistance of R_3 ohms between them and the line, the value of R_3 would have to be

$$R_3 = \frac{E}{2I} - \frac{r}{2} \text{ ohms}$$

in order to allow a current of I amperes to flow through each motor. The loss in the rheostat would then be

$$W_{R_3} = \frac{1}{2} (2I)^2 R_3 t = 2I^2 R_3 t = I^2 t \left(\frac{E}{I} - r \right) \text{ watt-seconds}$$

or exactly twice as great as in the case of series-parallel control.

138. Railway Controllers.—The successive changes in the starting resistance and the change from series to parallel connection are accomplished by means of a *controller*. As the controller is changed from notch to notch the resistance is varied by finite amounts, so that the current does not remain absolutely constant throughout the acceleration period, as represented by the line *ef*, Fig. 210, but in reality this curve assumes a saw-tooth form lying partly above and partly below the desired constant value. The two positions of the controller in which the motors are in full series and in full parallel, respectively, are called *running points* because in these positions there is no loss in the rheostat; all other positions are called *resistance points* except in the interval in which the transition from series to parallel connection takes place.

Controllers are commonly designated by characteristic letters which indicate the type to which they belong. Thus, type *R* controllers are those in which rheostatic control is used, without the customary series-parallel arrangement; they are used for single motor railway equipments, mining locomotives with one or two motors, and for cranes and hoists. Type *K* controllers are designed for series-parallel operation of two or more series motors, and have the characteristic feature of not breaking the power circuit during the transition from series to parallel

connection. Type *L* controllers are also designed for series-parallel control of series motors, and include the feature of opening the power circuit during the transition period; this type is now seldom used. Type *B* controllers have the usual power circuit connections, and in addition allow the motors to run as generators for energizing magnetic brakes of the axle or track type.

Fig. 212 represents a *K-10* controller made by the Westinghouse Electric and Manufacturing Co. and Fig. 213 shows the succes-

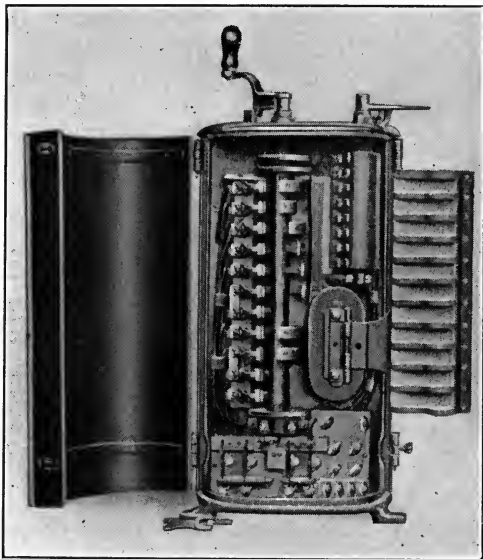

FIG. 212.—*K-10* controller, Westinghouse Elec. & Mfg. Co.

sive stages of the connections. The oval shaped part near the middle of Fig. 212 is a solenoid connected in the main power circuit; its function is to create a powerful magnetic field at the contacts between the stationary contact fingers and the segments on the controller spindle. This field is so directed as to blow out the arcs that form on breaking the circuit. Fig. 214 represents a more recent type of *K* controller made by the General Electric Co.; instead of a single magnetic blow-out coil, there are individual blow-out coils for each contact. The diagram of

connections of this controller are shown in Fig. 215. It will be observed that this diagram differs from that of Fig. 213 in that during the transition period the latter involves short-circuiting and immediately thereafter open-circuiting one of the motors (or pair of motors) while in the latter both motors are continu-

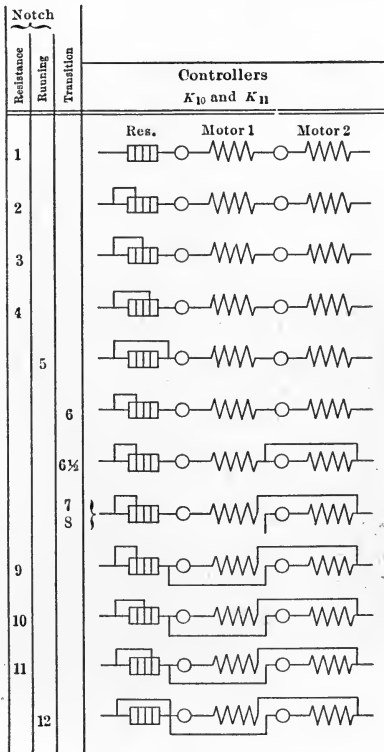

FIG. 213.—Successive stages of connections, K-10 controller.

ously in circuit. The system of transitional connections shown in Fig. 215 is called the *bridge control*.

All controllers, with the exception of certain *R* types, have two handles, one for the usual operation of accelerating the car, the other for the reversal of the direction of its motion. These two handles are mechanically interlocked in such a manner that the reversing handle cannot be moved unless the main handle is in the "off" position, and the main handle cannot be moved

unless the reversing handle is in either the forward or reverse position. The reversing handle changes the direction of rotation of the motors by interchanging the connections of the field windings with respect to the armature terminals.

If the car is running and it is desired to reduce speed, the controller handle should be turned quickly to the off position and then brought back again to the proper notch before the speed

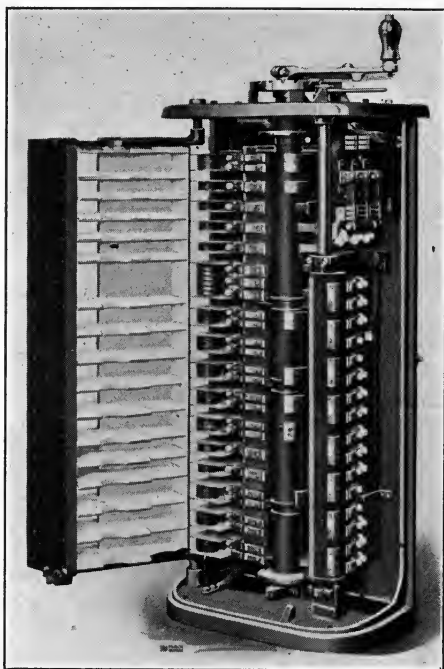

FIG. 214.—Railway motor controller with individual blow-out coils, General Electric Co.

has fallen too low. A slow turning off is apt to draw destructive arcs at the contact fingers.

A characteristic feature of all of the controllers described above is that the main current passes directly through them. This is perfectly feasible in the case of a single car, or motor car and trailer, but where several motor cars and trailers are to be operated as a train, the multiple-unit type of control, called type *M*, must be used. The controller for this service carries only a

small auxiliary current supplied by the line, and this current actuates electromagnets which operate *contactors* that control the main current. The contactors are usually mounted in waterproof iron cases under the car bodies. In this system a

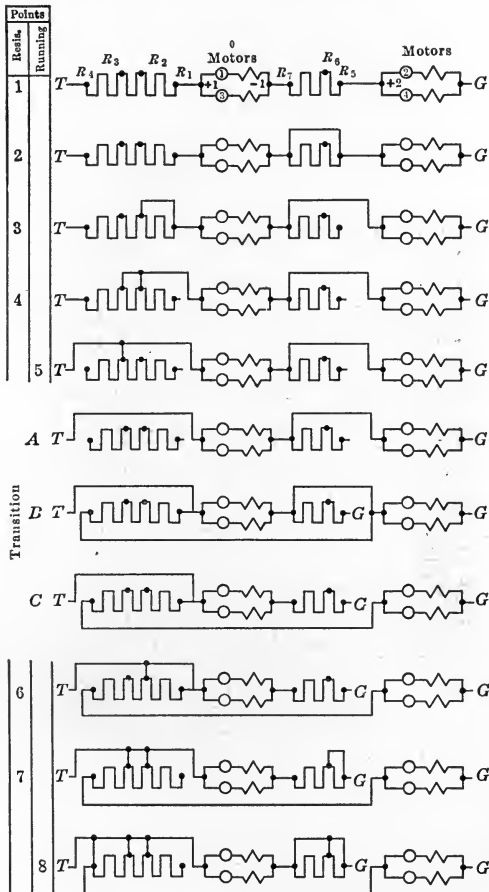

Fig. 215.—Bridge control, series-parallel system.

single controller, called a master controller, serves to operate the contactors of all the motor cars in the train, the auxiliary circuit being extended from end to end of the train.

A system similar to the type *M* is also used in large single cars,

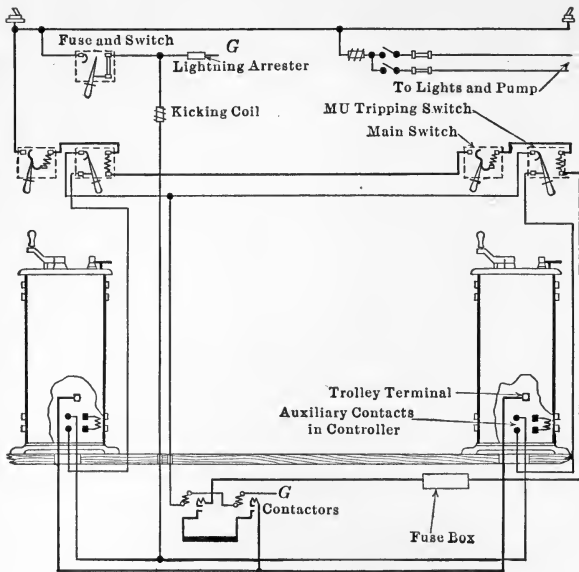

FIG. 216.—Railway motor controller with auxiliary circuits.

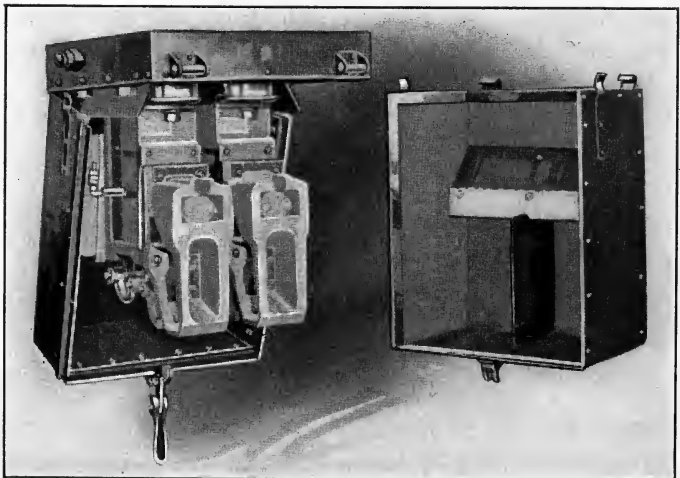

FIG. 217.—Contactor with cover removed.

where very heavy current through the controller itself might be objectionable. An elementary diagram of connection of such a controller is shown in Fig. 216, and the contactors are shown in Fig. 217. This type of control is not suitable on a system in which the trolley voltage is apt to be low, as at the end of a long feeder at times of heavy load; for in such a case it is possible that the current passing through the auxiliary circuit may be insufficient to operate the contactors.

139. Division of Load between Motors.—Two or more shunt motors designed for the same voltage, when connected in parallel to the same supply circuit, and with their shafts rigidly coupled, will divide the load in proportion to their capacities provided their speed-current curves (Fig. 191) are identical in the manner discussed in connection with Fig. 173; that is, if the speed curves, plotted in terms of per cent. of full-load current, are identical. The same thing is true of series motors operating in parallel.

Series wound motors when connected in series in a constant-current circuit, will develop approximately constant torque if the brushes are kept in a fixed position; but if the torque were constant the speed would have to vary in direct proportion to the load. To obviate this variation of speed, and in particular to keep the speed constant, the series motors in the Thury constant-current system (see Chap. VI) are provided with regulators which change the position of the brushes, thereby affecting the torque instead of the speed.

An interesting case of unequal division of load between series wound motors is afforded by the case of a car starting on an up-grade on slippery rails. Assume for example that the rear end of the car is more heavily loaded than the forward end; on turning the controller handle to the first notch, the same current will flow through both motors (or both pairs of motors) since they are in series with each other; therefore each will develop the same torque. If the weight on the forward trucks is fairly light, the adhesion between the wheels and the rail may not be sufficient to prevent slipping, in which case the forward motor will speed up and spin the wheels. The counter e.m.f. of the forward motor will increase as its speed rises, so that its impressed voltage must also increase; but any increase of the voltage on the forward

motor will be at the expense of that impressed on the already overworked rear motor, so that the result will be to stall the car unless the front wheels can be prevented from slipping.

PROBLEMS

1. A 220-volt compound wound motor has an armature resistance of 0.44 ohm, a shunt field resistance of 169 ohms, and a series field resistance of 0.15 ohm. Find the line current, the shunt field current and the counter e.m.f. when the armature current is 25 amp. (a) if the connections are long-shunt, (b) if they are short-shunt.

2. The series field winding of the motor of Problem 1 is disconnected and the motor, when operated as a shunt motor from 220-volt mains, takes a no-load armature current of 1.5 amp. and develops a speed of 997 r.p.m. Find the value of $\Phi Z'$ and the ideal zero-load speed.

3. The shunt motor of Problem 2 has a magnetization characteristic that can be represented by Froelich's equation, such that an increase of the shunt field resistance to 338 ohms reduces the flux by one-third. What will be the ideal no-load speed if the resistance of the shunt circuit is 220 ohms?

4. When the armature of the motor of Problem 2 is carrying its full-load current of 25 amp., the armature demagnetizing ampere-turns per pole amount to 6 per cent. of the field ampere-turns per pole. Find the speed (a) at full load, (b) when the armature current is 25 per cent. greater than its full-load value. The coefficient of dispersion is 1.2.

5. What is the total torque developed by the motor when the armature current has the values specified in Problem 4?

6. What resistance must be put in series with the armature of the motor of Problem 2 to make it develop (a) full-load torque at the moment of starting, (b) a starting torque 25 per cent. greater than full-load torque?

7. The series field winding of the motor of Problem 1 is connected so that the motor is a differential long-shunt compound motor. The series field excitation amounts to 20 per cent. of the shunt excitation when the armature current is 25 amp. Find the speed of the motor when the armature current is 25 amp.

8. If the series field of Problem 7 is reversed, what will be the speed when the armature current is 25 amp.?

9. The motor specified in Problem 2 is connected as a shunt machine and is driven as a generator at a speed of 1000 r.p.m. The field rheostat is adjusted until the shunt current is 1.3 amp. Find the terminal voltage when the armature current is 25 amp. (a) when the direction of rotation results in a forward lead of the brushes, (b) when the direction of rotation is reversed.

10. A street-car is equipped with four motors which have characteristics shown in Fig. 208. Each motor is mounted on its own axle, the gear ratio being 25 : 73. The driving wheels on three of the axles have diameters of 33 in., while those of the fourth are 32 in. in diam. When the car is moving at a speed of 24 miles per hr., with all motors in parallel, what is the current taken by each motor and what is the total tractive effort?

CHAPTER VIII

COMMUTATION

140. Fundamental Considerations.—Each of the a parallel paths comprising the entire armature winding consists of $Z/2a$ turns in series in each of which the current is i_a/a amperes. As the commutator segments to which the terminals of the individual winding elements are connected pass under the brushes, the elements are successively switched from a path or circuit in which the current has one direction to an adjoining circuit in which the current has an opposite direction. During this transition period, or period of commutation, the current must be reduced from its original value to zero and then built up again to an equal value in the opposite direction. The period of commutation is of very brief duration, of the order of 0.0005 to 0.002 second, and it may easily happen that the reversal of current is either retarded or unduly accelerated; in either case, the current at the end of the period will tend to have a value which differs from that of the circuit to which the commutated coil is about to be connected, and the result of the final equalization is a spark between the brush and the commutator segment. The study of the commutation process therefore has for its object the determination of the conditions which will result in sparkless operation.

The time variation of the current in a winding element may be represented by a diagram such as Fig. 218, in which ordinates represent values of current and abscissas the time. Immediately before the beginning of the commutation period AB , the current in the coil under consideration has the value $+i_0 = i_a/a$; after the completion of the commutation it must have a value $-i_0$, assuming that the winding is symmetrical and, therefore, that the currents in all of the armature circuits are the same. In the time interval $AB = T$, the current may vary in the manner shown by such typical curves as a, b, c, d, e, f ,

each of which corresponds to a definite set of physical conditions. These curves are called the *short-circuit current curves*.

Curve *a* shows that the current has been reversed too rapidly, overreaching its final value, such a condition being characterized as overcommutation. Here the current may reach its proper final value without a spark, but it may involve such large localized current densities at the contact surface between commutator segment and brush as to lead to sparking and, perhaps, to glowing (incandescence) of the brush and certainly to excessive loss and heating and deterioration of the brush.

Curve *b* represents a case in which the current comes to its

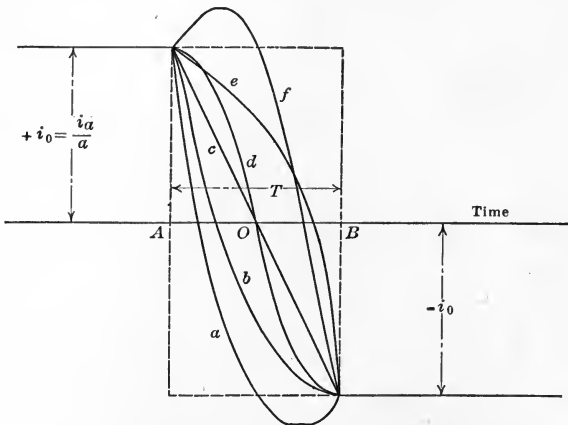

FIG. 218.—Types of short-circuit current curves.

final value smoothly, with a zero rate of change at the end of the commutation period. This will generally result in satisfactory commutation.

Curve *c* indicates a uniform transition of the current from its initial to its final value. When this occurs the commutation is said to be linear. Linear commutation is very desirable, for, as will appear later, it gives rise to uniform current density at the brush contact surface and the loss of power at the contact surface is a minimum.

Curve *d* represents the so-called “sinusoidal” commutation; the curve is one-half of a sine curve. Such a short-circuit current curve would generally result in satisfactory commutation.

Curve *e* represents a limiting case in which the final rate of change of current is infinite; that is, the curve is tangent to the vertical line drawn through *B*. Under such conditions sparking would invariably result.

Curve *f* shows "undercommutation," that is, the current is not reversed with sufficient rapidity. Even though the final value of current may be correct, this condition may involve excessive current density under the brushes and hence possible glowing, just as in the case of overcommutation.

It should be understood that these curves represent only the more important cases. In practice, the short-circuit current curves may assume an infinite variety of forms, subject always to the condition that the initial and final values of current must be equal in magnitude and opposite in sign, the armature winding being assumed to be symmetrical.

No account has here been taken of the effect of mechanical irregularities such as vibration of the brushes, unevenness of the commutator surface, etc. Such mechanical defects will invariably produce sparking even though the magnetic and electrical conditions are otherwise perfect. Vibration of the brushes causes the short-circuit current curves to take on a saw-tooth form.

141. Physical Basis of the Theory of Commutation.—The theory of commutation is much less advanced than that of other parts of the theory of direct-current machines; that is to say, the commutation characteristics cannot be predetermined with anything like the degree of accuracy that is possible in the calculation of the general performance characteristics. Notwithstanding this fact, practice based upon more or less empirical rules has so far outstripped theory that manufacturers commonly guarantee sparkless operation between no-load and 50 per cent. overload with a fixed setting of the brushes.

The elementary theory of commutation is relatively simple and has been extensively discussed by numerous writers. It involves the fact that the coil undergoing commutation has induced in it an e.m.f. of self-induction due to the changing current in the coil, the self-induced e.m.f. acting always in such a direction as to oppose the change of current; and in case the short-circuited coil is in inductive relation to one or

more coils which are simultaneously undergoing commutation there will also be induced in it an e.m.f. of mutual induction. For these reasons the theory may be designated the "inductance" theory. There is also to be considered the fact that the short-circuited coil may be situated in a magnetic field—the fringing field near a pole tip, or the reversing field due to a commutating pole—and that the rotation of the coil through this field produces a generated e.m.f. in the coil. As has been previously pointed out, this generated e.m.f. should in general be so directed as to neutralize the retarding effect of self-induction, in which case the process is referred to as *voltage commutation*. If, however, the commutated coil is not acted upon by any extraneous field, that is, if there is no generated e.m.f. acting in it, the process is called *resistance commutation* inasmuch as the self-induced e.m.f. is controlled only by the ohmic drops in the coil and at the brush contact surface. Resistance commutation is largely relied upon in machines having a fixed brush position and no special commutating devices such as interpoles; to this end carbon brushes are employed, the high contact resistance serving to keep the short-circuit current within reasonable limits. Examples of this type of machines are afforded by railway and hoisting motors in which the brushes are permanently set at the geometrical neutral because of the frequent reversal of direction of rotation.

The ohmic drops at the transition surface between the commutator segments and the brushes, and in the short-circuited coils and their connecting leads are almost as important as the e.m.fs. due to self- and mutual-induction and to rotation through the magnetic field. The contact resistance between commutator and brushes is very much more complex in its nature than that of ordinary metallic conductors; it resembles that of the electric arc in many of its properties, for it is dependent upon such factors as the current density, the direction of the current, the temperature, material and chemical structure of the contact surfaces, and upon the nature of the current itself (continuous, alternating, or pulsating); it varies, moreover, with the contact pressure and the relative velocity of the surfaces.¹

¹ A very complete presentation of the effects of all of these factors will be found in Arnold's *Die Gleichstrommaschine*, Vol. I.

It is probable that the passage of the current across the transition surface between commutator and brush causes an ionization of the gaseous layer between them and that this sets up a counter e.m.f. similar to that encountered in the arc stream. From this standpoint the drop of potential across the contact surface is the sum of the counter e.m.f. and the true ohmic drop; the quotient obtained by dividing the observed drop by the current is then not a true resistance, but what may be called an effective resistance, made up of the true resistance plus a fictitious resistance equivalent in its effects to the counter e.m.f. The transition layer between commutator and brush is the seat of an energy storage, and breakdown in the form of sparking may be expected when the amount of the stored energy exceeds a critical value. On this basis, neither current density nor transition drop taken separately is a sufficient criterion of the sparking limit; this is confirmed by an experiment of Professor Arnold's in which the current density passing from a carbon brush to a metal surface was raised until the brush glowed, but without producing sparking.

THE INDUCTANCE THEORY

142. General Equation, Case of Simple Ring Winding.—For the sake of simplicity there will first be considered a simple ring winding in which the brush width b is equal to the width β of a commutator segment. Under this condition only one winding element will be short-circuited at a time, as shown in Fig. 219, and the effect of the mutual induction of other coils is eliminated. It has been explained in Chap. VI that the axis of commutation must be slightly displaced from the neutral axis (in the direction of rotation in the case of generators), in order that the fringing field at the leading pole tip may generate in the short-circuited element an e.m.f. of sufficient magnitude to balance the retarding effect of the self-induced e.m.f. But during the commutation period the short-circuited coil moves through the fringing field from a position in which the generated e.m.f. has a certain value to another position in which the generated e.m.f. is appreciably larger, so that the reversing e.m.f. is not constant. If the distribution of the flux in the air-gap is determined experimentally, as by the pilot brush method de-

scribed in Chap. V, it will be found that, as a rule, the curve of flux distribution is approximately linear for short distances between pole tips; therefore, the commutating e.m.f. may be closely represented by the function

$$E_c = e + ht \quad (1)$$

where

t = time counted from the beginning of the commutation period

h = constant

e = commutating e.m.f. at the beginning of the period, when $t = 0$.

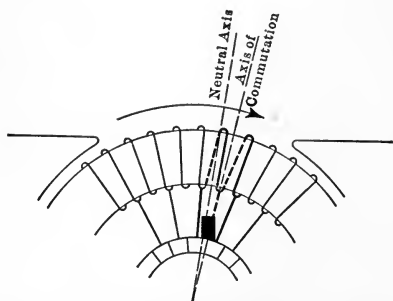

FIG. 219.—Short-circuited element, simple ring winding.

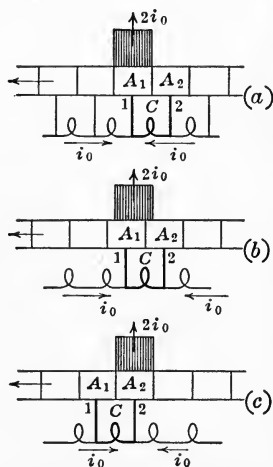

FIG. 220.—Successive phases of short-circuit of coil.

Parts a , b , and c of Fig. 220 represent, respectively, the initial, intermediate, and final stages of the commutation of a coil C . In position a the coil is a part of the right-hand branch of the winding and carries the current $i_0 = i_a/a$. All of the current reaching the brush from the two adjoining paths must then pass through lead 1. Similarly, in the final position c , coil C has become an integral part of the left-hand branch, its current has been fully reversed, and the combined current of the two paths must reach the brush by way of lead 2. The b position, in which coil C is short-circuited, shows that immediately after segment A_2 has reached the brush, the current from the right-

hand branch may reach the brush by way of both leads 1 and 2, and coil C therefore carries less current than before; as the contact area of segment A_1 diminishes and that of A_2 increases, the original current through C is diverted more and more from lead 1 to lead 2. At the same time that the right-hand branch current is being throttled in this way out of coil C , the left-hand branch current finds its way more and more readily through coil C and the increasing contact area A_2 , and less and less readily through the diminishing contact area A_1 .

If the transfer of the brush current, $2i_0$, from lead 1 to lead 2 occurs uniformly during the commutation period, *linear commutation* results. In that case the current in C will have zero value when the insulation between segments A_1 and A_2 is directly under the middle of the brush; and leads 1 and 2 will then each be carrying current i_0 , from the left- and right-hand circuits, respectively. But if the axis of commutation is too near the leading pole tip (in the case of a generator) the e.m.f. generated in C by its motion through the field will act to accelerate the transfer of current from lead 1 to lead 2, therefore giving rise to abnormal current densities at the contact area A_2 ; this is the case of overcommutation, Fig. 218a. On the other hand, a commutating field that is too weak will delay the transfer of current from lead 1 to lead 2, so that the current density may become excessive at contact area A_1 ; this corresponds to the curve of undercommutation, Fig. 218f.

143. Elementary Mathematical Relations.—Fig. 221 is the same as Fig. 220b except that the currents in the various paths are indicated. It may be assumed that the currents from the left-hand and right-hand paths pass to the commutator by way of leads 1 and 2, respectively, and that the current in the coil C has a value which at any instant is i amperes, its path being completed through the brush. In the figure the current i is represented as flowing in a clockwise direction through the short circuit but at a later instant during the commutation period it will have reversed. From the figure it follows that the currents in leads 1 and 2 are, respectively,

$$\left. \begin{aligned} i_1 &= i_0 + i \\ i_2 &= i_0 - i \end{aligned} \right\} \quad (2)$$

$$\therefore i_1 + i_2 = 2i_0 = \text{total current from the brush.} \quad (3)$$

Now let

R_c = resistance of coil C

R_l = resistance of each commutator lead

R_b = resistance of contact area of the entire brush.

Counting the time t from the beginning of the short-circuit of coil C , the contact resistances of areas A_1 and A_2 are, respectively,

$$R_1 = R_b \frac{T}{T-t}, \quad R_2 = R_b \frac{T}{t}$$

In the closed circuit consisting of coil C , commutator leads 1 and 2, contact areas A_1 and A_2 , the two commutator segments and the brush, the sum of all the potential drops (with due regard to sign) must equal zero, in accordance with Kirchhoff's law. The sign of any e.m.f. is to be taken positive or negative if it acts in, or in opposition to, some arbitrarily assumed positive

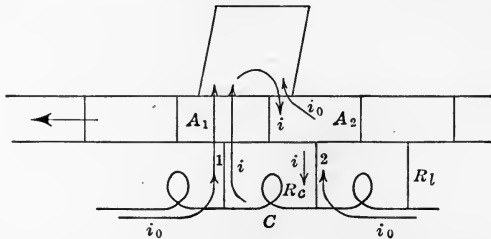

FIG. 221.—Current paths in short-circuited coil.

direction, respectively; similarly, a drop of potential due to a current flowing in the positive direction is to be taken with the negative sign, and *vice versa*. Taking the counter-clockwise direction as positive, we have

$$-L \frac{di}{dt} = \text{e.m.f. of self-induction (negative)}$$

$$iR_c = \text{ohmic drop in coil } C \text{ (positive)}$$

$$i_1 R_l = \text{ohmic drop in lead 1 (positive)}$$

$$i_1 R_1 = \text{ohmic drop in contact area } A_1 \text{ (positive)}$$

$$i_2 R_2 = \text{ohmic drop in contact area } A_2 \text{ (negative)}$$

$$i_2 R_l = \text{ohmic drop in lead 2 (negative)}$$

$$E_c = \text{commutating e.m.f. (positive).}$$

$$\therefore L \frac{di}{dt} + iR_c + (i_0 + i)R_l + (i_0 + i)R_b \frac{T}{T-t} -$$

$$(i_0 - i)R_b \frac{T}{t} - (i_0 - i)R_l + E_c = 0 \quad (4)$$

which may be written

$$L \frac{di}{dt} + iR + \frac{R_b T}{T - t} (i_0 + i) - \frac{R_b T}{t} (i_0 - i) + E_c = 0 \quad (5)$$

where

$$R = R_c + 2R_t$$

This equation involves the justifiable assumption that the resistances of the commutator segments and of the brush are negligible.

The complete integration of this differential equation has been worked out subject to certain conditions¹ and results in an equation of the form

$$i = F(t)$$

subject to the terminal conditions that when $t = 0$, $i = i_0$, and when $t = T$, $i = -i_0$. The complete results of the integration are not essential in most cases, since it is generally the end of the commutation period that is most important so far as sparking is concerned.

144. Discussion of the General Equation.—At the last moment during the commutation process, when $t = T$, and $i = -i_0$

$$\begin{aligned} E_c &= e + hT = E_T \\ \frac{R_b T}{t} (i_0 - i) &= 2R_b i_0 \\ \frac{R_b T}{T - t} (i_0 + i) &= \frac{0}{0}, \text{ or indeterminate.} \end{aligned}$$

The value of the expression $\left(\frac{i_0 + i}{T - t}\right)$ can, however, be evaluated by differentiating numerator and denominator separately with respect to the independent variable t , giving

$$\frac{i_0 + i}{T - t} \Big|_{t=T} = \frac{\frac{di}{dt}}{-1} = - \frac{di}{dt}$$

The general equation then reduces to

$$L \frac{di}{dt} - i_0 R - R_b T \frac{di}{dt} - 2R_b i_0 + E_T = 0$$

or

$$\left(\frac{di}{dt}\right)_{t=T} = - \frac{i_0(R + 2R_b) - E_T}{R_b T - L} \quad (6)$$

¹ Über den Kurzschluss der Spulen und die Vorgänge bei der Kommutation des Stromes eines Gleichstromankers, by Paul Riebesell. Kiel, 1905.

From the last equation (6) there may be deduced several important conclusions, as follows:

1. If $\frac{R_b T}{L} = 1$, the final value of $\frac{di}{dt}$ will be infinite, *i.e.*, $\left(\frac{di}{dt}\right)_{t=T} = \infty$, provided $i_0(R + 2R_b)$ differs from E_T . If this were the case, the e.m.f. of self-induction, $-L\frac{di}{dt}$, would also be infinite, and sparking would result at the trailing edge of the brush. Therefore, $\frac{R_b T}{L}$ must in general differ from unity.

2. Inspection of Fig. 218a shows that in case of overcommutation the final rate of change of current in the coil is positive in sign; since this condition of overreaching is to be avoided, the rate of change of current should always be negative, hence the numerator and denominator of equation (6) must be of the same sign. If, then,

$$\frac{R_b T}{L} > 1, \quad i_0(R + 2R_b) > E_T \quad (7)$$

and if

$$\frac{R_b T}{L} < 1, \quad i_0(R + 2R_b) < E_T \quad (8)$$

Inasmuch as most machines are required to operate with the brushes in a fixed position, close to the neutral axis, the commutating e.m.f. E_c , and also its terminal value, E_T , will generally be small. Usually, therefore, $E_T < i_0(R + 2R_b)$, hence

$$\frac{R_b T}{L} > 1$$

is in most cases the criterion for satisfactory commutation.

3. The final rate of change of current will be zero, *i.e.*, $\left(\frac{di}{dt}\right)_{t=T} = 0$, if

$$E_T = i_0(R + 2R_b) \quad (9)$$

in which case the conditions for good commutation will be favorable. This state of affairs is shown in curve *b*, Fig. 218.

145. Modified Form of Sparking Criterion.—The condition $\frac{R_b T}{L} > 1$ can be put into another form which has a simple physical

interpretation; multiplying both sides of the inequality by $2i_0L/T$, we have

$$2i_0R_b > \frac{2i_0}{T} L = e_r \quad (10)$$

The term $2i_0R_b$ is the drop of potential at the brush contact surface and is usually of the order of 1 volt with carbon brushes. The term $2i_0/T$ is the average rate of change of current during commutation, hence $e_r = 2i_0L/T$ is the average reactance voltage, or average e.m.f. of self-induction. It follows, therefore, that $e_r < 1$ is the condition to be satisfied.

The criterion $R_bT/L > 1$ shows that the brush contact resistance R_b and the time of commutation T must be large, and that L must be kept small. This accounts for the fact that carbon brushes are ordinarily superior to metal brushes, since the former have the larger contact resistance.

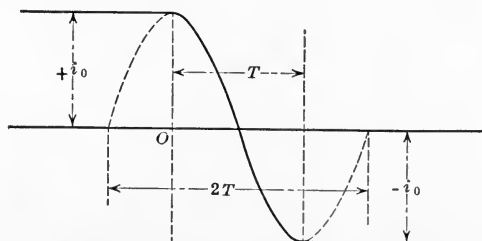

FIG. 222.—Sinusoidal commutation.

The self-inductance L can be kept within limits by designing the elements with a small number of turns, the inductance being proportional to the square of the number of turns; in large machines the elements are designed with only a single turn; ordinarily the number of turns per element should not exceed 2 or 3, though in railway motors the number is frequently 4 or 5. Furthermore, since the value of L is determined by the number of flux linkages per ampere of current in the coil, L can be kept down by limiting the axial length of the armature; this means, for a given capacity of machine, a relatively large diameter, hence the possibility of using a large commutator, a correspondingly large number of segments, and a small number of turns per segment and per element.

It would appear at first glance that an increase in brush width would give good results because of the increased value of T . But this apparent advantage is offset because of the fact that the wide brush simultaneously short-circuits several additional coils whose mutual inductance is equivalent to an increase in the self-inductance of the original coil (see Art. 154).

The criterion $R_b T/L > 1$, or $e_r = 2i_0 L/T < 1$ is frequently expressed in a still different form. H. M. Hobart has proposed a method which assumes that the commutation curve (Fig. 218*d*) is one-half of a sine curve of period $2T$, as indicated in Fig. 222, the maximum ordinate being i_0 , whose equation, referred to origin O, is

$$i = i_0 \cos \frac{2\pi t}{2T}$$

The instantaneous value of the self-induced e.m.f. is then

$$e = -L \frac{di}{dt} = \frac{\pi}{T} L i_0 \sin \frac{2\pi t}{2T}$$

and its maximum value, which Hobart calls the reactance voltage, is

$$e_{max} = \frac{\pi}{T} L i_0 = \frac{2i_0}{T} L \cdot \frac{\pi}{2} = \frac{\pi}{2} e_r \quad (11)$$

Hence, if $e_r < 1$, $e_{max} < 1.57$. As usually stated, however, $e_{max} < 2$. It follows from the previous discussion that if $e_r > 1$, or $e_{max} > 2$, the commutating e.m.f. must be so adjusted that $E_T > i_0(R + 2R_b)$.

146. Linear Commutation.—Equation (5) can be utilized to determine the conditions necessary for a uniform transition of the current from its initial to its final value. Thus, in case of linear commutation, curve *c*, Fig. 218, the current i at any instant t is given by

$$i = i_0 - \frac{2i_0}{T} t = i_0 \frac{T - 2t}{T}$$

and

$$\frac{di}{dt} = -\frac{2i_0}{T}$$

Substituting these values in (5), there results after some transformation

$$E_c = i_0 \left[\frac{2L}{T} - \frac{R}{T} (T - 2t) \right] \quad (12)$$

It follows from (12) that when

$$t = 0, E_c = e = i_0 \left(\frac{2L}{T} - R \right)$$

$$t = T, E_c = E_T = i_0 \left(\frac{2L}{T} + R \right)$$

In other words, the commutating e.m.f. must not only vary as a linear function of the time, as shown by equation (12), but it must also change with the load since it is directly proportional to i_0 . It follows, therefore, that if conditions for perfect linear commutation were satisfied for one particular load they would not be satisfied for other loads, without special corrective devices.

An interesting consequence of linear commutation is that the current density at the brush contact is constant. Thus, referring to Fig. 221,

$$i_1 = i_0 + i$$

$$i_2 = i_0 - i$$

and if

$$i = i_0 \frac{T - 2t}{T}$$

it follows that

$$i_1 = 2i_0 \frac{T - t}{T}$$

$$i_2 = 2i_0 \frac{t}{T}$$

But the contact areas A_1 and A_2 are given by

$$A_1 = A \frac{T - t}{T}$$

$$A_2 = A \frac{t}{T}$$

where A is the total brush area; hence the current density is

$$\frac{i_1}{A_1} = \frac{i_2}{A_2} = \frac{2i_0}{A} = \text{constant.} \quad (13)$$

It can also be shown that the ohmic loss due to the resistance of the brush contact is a minimum in the case of linear commutation, that is, when the current density is uniform. For let it be assumed that the short-circuit current in coil C , Fig. 221, is not linear; in this case the actual non-linear current can be

thought of as made up of a linear current, i_l , and an extra current, i_x , where the latter may have any general form. It follows then that

$$i = i_l + i_x$$

and

$$\begin{aligned} i_1 &= i_0 + i = i_0 + i_l + i_x \\ i_2 &= i_0 - i = i_0 - i_l - i_x \end{aligned}$$

The contact resistances at the areas A_1 and A_2 are, respectively,

$$R_1 = R_b \frac{T}{T - t}$$

and

$$R_2 = R_b \frac{T}{t}$$

and the ohmic loss at the contact areas is

$$W_c = i_1^2 R_1 + i_2^2 R_2$$

Substituting for i_1 , i_2 , R_1 and R_2 , and remembering that $i_l = i_0 \frac{T - 2t}{T}$, we find that

$$\begin{aligned} W_c &= 4i_0^2 R_b + i_x^2 R_b \left(\frac{T}{T - t} + \frac{T}{t} \right) \\ &= 4i_0^2 R_b + i_x^2 R_b \frac{T}{t(1 - t/T)} \end{aligned} \quad (14)$$

from which it follows that the loss is a minimum if $i_x = 0$, *i.e.*, if the commutation is linear.

147. The Current Density at a Commutator Segment.—General Case.—The uniform current density over the brush width that is characteristic of linear commutation means that the drop of potential across the contact surface is everywhere the same and, therefore, that there are no differences of potential along the brush contact (in the peripheral direction) to be equalized by a flow of current. It follows, then, that if such inequalities of potential do exist, or tend to exist, extra currents will flow along the brush and complete their paths through the short-circuited coil or coils, thereby giving rise to non-linear short-circuit current curves and a non-uniform current density. Of course, the potential differences which produce the extra currents are due to the fact that the e.m.f. generated in the

short-circuited coils differs in form, as a time function, from that which would produce linear short-circuit current. It is consequently important to determine in what manner the distribution of current density is affected by a non-linear short-circuit current. For this purpose the following graphical method, due to Professor Arnold,¹ may be used.

Consider, for example, a case where the brush width is 3.5 times the width of a commutator segment, and let it be assumed that the current density at any given instant is the same over the entire area of that part of the segment covered by the brush. Assume also that all the coils successively undergoing commutation have identical short-circuit current curves. The current density at a particular segment *S* will then change from

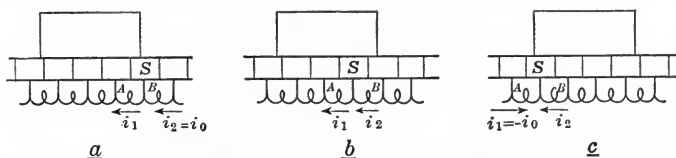

FIG. 223.—Successive phases of short-circuit, wide brush.

instant to instant as it passes under the brush. Three distinct phases of its motion may be recognized:

- 1st, the segment approaches the brush,
- 2d, the segment is covered by the brush,
- 3d, the segment emerges from the brush,

as shown in Fig. 223, parts *a*, *b*, and *c*, respectively.

Phase 1.—The current crossing from segment *S* to the brush is

$$i_2 - i_1 = i_0 - i_1$$

the upward direction of current through the segment being taken as positive.

Phase 2.—The current crossing from segment *S* to the brush is

$$i_2 - i_1$$

Phase 3.—The current crossing from segment *S* to the brush is

$$i_2 - i_1 = i_2 + i_0,$$

since in this position coil *A* is carrying current from the left-hand branch circuit, *i.e.*, $i_1 = -i_0$.

¹ Die Gleichstrommaschine, Vol. I, p. 438, 2nd ed.

In Fig. 224, curves C_A and C_B represent the short-circuit current curves of coils A and B , respectively. They are drawn in their correct time positions with respect to the edge 1 of the brush, the line OO' being the axis of their ordinates; in the position shown in the figure the first phase of the motion of segment S is just beginning.

When the commutator has moved to the left a distance x_1 (during phase 1), the current in coil A is ab , and the current across segment S is

$$i_2 - i_1 = i_0 - i_1 = ac - ab = bc$$

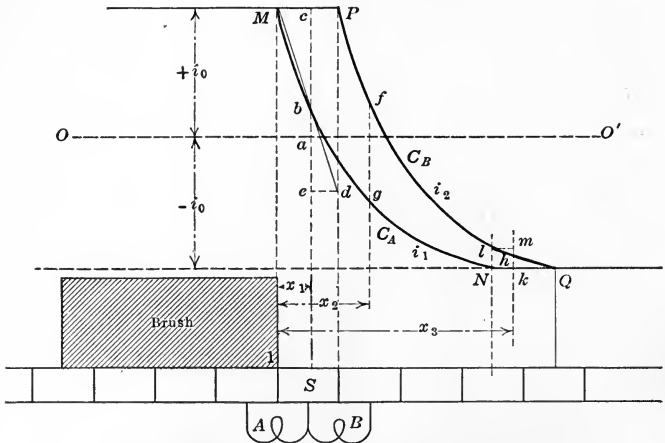

FIG. 224.—Current density at a segment.

The current density is proportional to

$$\frac{i_0 - i_1}{x_1} = \frac{bc}{Mc}$$

Draw the straight line Mb and produce it until it cuts the vertical through P in the point d , then

$$\frac{bc}{Mc} = \frac{Pd}{MP}$$

and since MP is a constant length, Pd is proportional to the current density at segment S . Projecting the point d across to e , ce is the current density corresponding to the abscissa x_1 .

It is readily apparent from this construction that a too rapid initial reversal of the current in a coil (overcommutation) may result in excessive current density at a segment as it passes under the brush.

During the second phase, or after a travel of the commutator represented by x_2 , the current across segment S , *i.e.*, $i_2 - i_1$, is given directly by the intercept fg between curves C_A and C_B . This intercept is also proportional to the current density to the same scale as ce .

During the third phase of the motion, or after a travel indicated by x_3 , the current across S is

$$i_2 - i_1 = i_2 + i_0 = hk$$

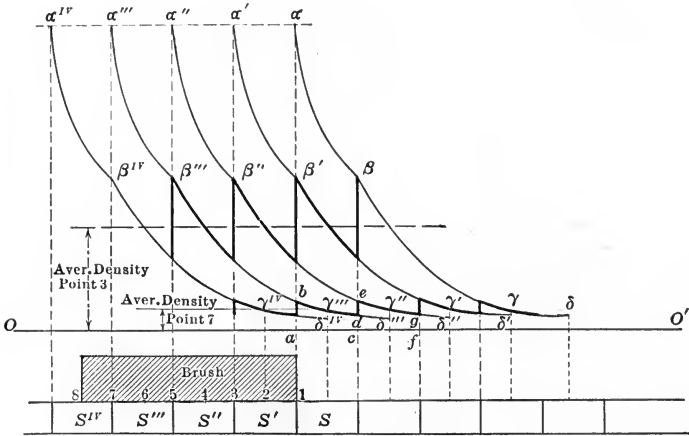

FIG. 225.—Curves of current density at segments.

At the same time the length of the segment still in contact with the brush is kQ , hence the current density is proportional to $\frac{hk}{kQ}$ or, to the scale previously adopted, it is represented by $lN = mk$. The point l is found by drawing the straight line Qhl .

Continuing this method for several points in each of the three phases of the process, the current density curve $\alpha\beta\gamma\delta$ of Fig. 225 is obtained. For convenience, the ordinates representing current density have been drawn upward with respect to the

axis OO' . Similar curves, $\alpha'\beta'\gamma'\delta'$ and $\alpha''\beta''\gamma''\delta''$, etc., show the variation of current density of segments S' and S'' , etc., respectively, and to the same time scale as that of curve $\alpha\beta\gamma\delta$.

148. Variation of Local Current Density at the Brush.—

Except in the case of linear commutation, the current density is not the same at the same instant all along the arc of contact of the brush, nor does it remain constant at any given point. For instance, in Fig. 225 consider the point 7 of the brush, which is just about to make contact with segment S''' . At this instant the current density of segment S''' is ab , as read from curve α''' , and thereafter, until S''' has moved from under the point,

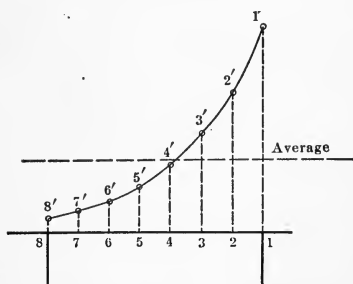

FIG. 226.—Average local current density at points along brush.

the current density changes in accordance with curve bd ; segment S'' then comes under point 7, the density rises suddenly from dc to ec , the point e being on curve α'' , and again falls off to the value gf . The curve eg is, of course, the same as bd ; in other words, the current density at a given point in the brush varies periodically. In precisely the same way the saw-tooth line with

cusps at β , β' , β'' , etc., represents the variation of current density at point 3 of the brush.

If the average current density is found for various points along the brush, the results when plotted give the curve $1'2'3' \dots 8'$ of Fig. 226. This is the curve of average local current density that corresponds to the curve of commutation MN or PQ of Fig. 224. It is readily apparent from Fig. 226 that the local current densities may differ considerably from the average current density of the brush as a whole.

149. Further Examples.—Using the above methods, curves of current density have been constructed for several types of short-circuit current curves. They are shown in Figs. 227, 228, and 229. The case of linear commutation is not shown, since it is obvious from the previous analytical discussion, as well as from the geometry of the construction, that the current

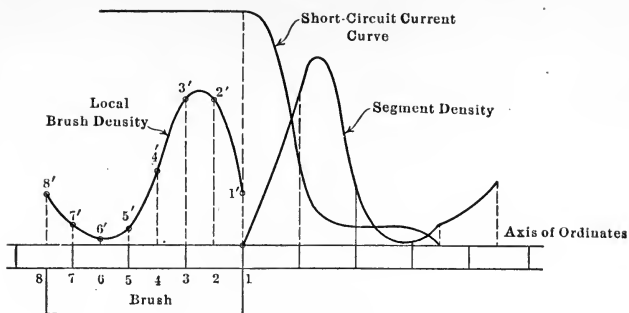

FIG. 227.

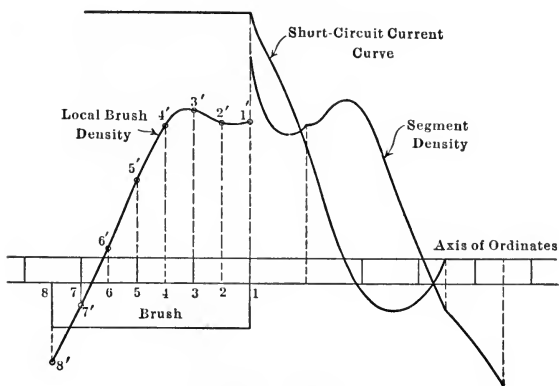

FIG. 228.

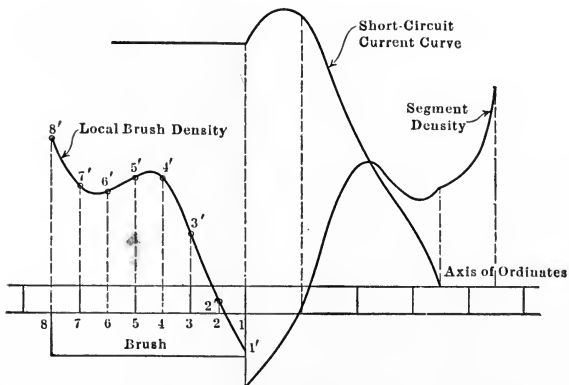

FIG. 229.

Figs. 227, 228, 229.—Curves of current density at segments and brushes.

density is the same at all times both at the segments and at each point of the brush.

Figs. 227 and 228 represent cases in which the rate of change of current is too great during the initial stages of the commutation period. This results in correspondingly great current densities at the commutator segments as they come under the brush, and high average brush current density near the heel. In Fig. 228 the overreaching of the current in the coils causes a reversal of direction of current at the receding segments. Fig. 229 shows a case of undercommutation, with consequent reversal of direction at the heel of the brush and excessive densities near the end of the commutation period.

150. Simultaneous Commutation of Adjacent Coils.—Inasmuch as the process of commutation in a coil is affected by the

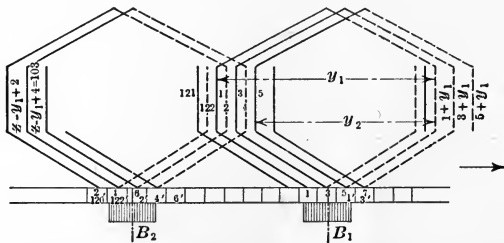

FIG. 230.—Simultaneous short-circuit of elements of lap winding.

mutual induction of neighboring short-circuited coils, it is important to be able to predetermine the number and relative positions of those coils in the same neutral zone which are simultaneously short-circuited. In the case of the simple ring winding heretofore considered, all coils in the same zone are short-circuited by a single brush; if b is the brush width and β the width of a commutator segment, the ratio b/β fixes the number of coils short-circuited at the same time. This ratio is generally a mixed number, and the actual number of coils short-circuited will vary alternately between the two integers lying on either side of it. In lap and wave windings, however, the conditions are as a rule not so simple, since in a given neutral zone some of the conductors are short-circuited by a brush of one polarity, others by a neighboring brush of opposite polarity, as illustrated

in Fig. 230. The diagram represents a duplex lap winding having the following constants:

$$\begin{array}{llll} Z = 122 & S = 61 & p = 6 & a = 12 \\ y = m = \frac{a}{p} = 2 & y_1 = 23 & y_2 = -19 & \frac{b}{\beta} = 2.5 \end{array}$$

It is clear from the figure that in the position shown, conductors 1 and 4 are simultaneously short-circuited; a moment earlier conductors 1, 3 and 4 were short-circuited. The successive combinations of short-circuited coils can be conveniently studied by means of the following graphical method, due to Professor Arnold.¹

1. Lap Windings.

It will be observed that in the winding here selected brushes B_1 and B_2 are not identically situated with respect to the segments of the commutator in contact with them. This is a consequence of the fact that S/p is not an integer.

Coil edges 1, 3, 5, etc., drawn in full lines to indicate that they occupy the tops of the slots, are connected to commutator segments which are correspondingly numbered in the top row of figures. The other sides of the same coils, whose numbers are $1 + y_1$, $3 + y_1$, $5 + y_1$, etc., are connected to segments which are numbered $1'$, $3'$, $5'$, etc. (*i.e.*, dropping the term y_1 and priming the numeral) in the bottom row of figures. A coil will then be short-circuited when the brush B_1 is in contact with any pair of segments which bear the same numbers. A similar arrangement is indicated in the case of coil edges 2, 4, etc.

Now, coil edge 2 is connected to one on the left which is separated by a pitch y_1 from 2, and by $y_1 - 1$ from 1. Segment 2 is therefore separated from 1 by $\frac{1}{2}(y_1 - 1)$ segments. But brushes B_2 and B_1 are separated by S/p segments, hence the relative shift of segments in the vicinity of B_2 with respect to those at B_1 is

$$\Delta = \frac{S}{p} - \frac{1}{2}(y_1 - 1) \tag{15}$$

and is toward the left when Δ is negative, toward the right when it is positive. In the case considered in Fig. 230, $\Delta = -\frac{5}{6}$.

The simultaneous action of the two brushes can now be studied

¹ Die Gleichstrommaschine, Vol. I, p. 354, 2nd ed.

by means of a diagram like Fig. 231; take a strip of paper cut to the width of the hatched area to represent the brush and slide it between the two commutators; when it touches segments similarly numbered, the corresponding coils will be simultaneously short-circuited

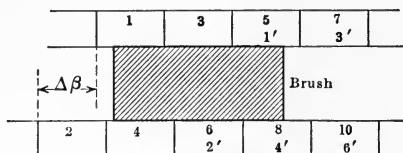

FIG. 231.—Diagram showing coils simultaneously short-circuited—lap winding.

2. Wave Windings.

Fig. 232 represents a portion of a duplex wave winding having the following constants:

$$Z = 122 \qquad S = 61 \qquad p = 6 \qquad a = 4$$

$$y = y_1 = y_2 = 21 \qquad \frac{b}{\beta} = 2.5$$

In the position shown, coil edges 122, 1, 2, 3, and 4 are short-circuited.

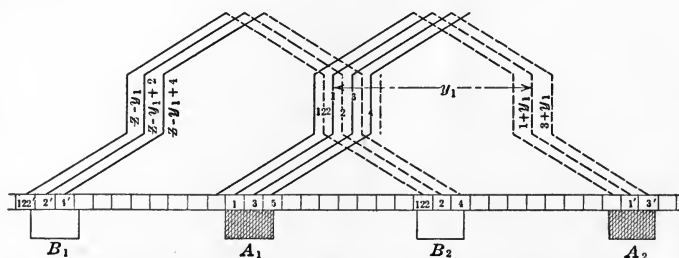

FIG. 232.—Simultaneous short-circuit of elements of wave winding.

Number the segments connected to coil edges 1, 3, 5, etc., with corresponding numbers, and the segments connected to the other sides of the same coils 1', 3', 5', etc.; similarly with respect to the other coils occupying the same neutral zone, as 2, 4, 6.

Brushes A_1 and A_2 , which are of the same polarity, are not similarly placed with respect to the segments in contact with them. The brushes are separated by $2S/p$ segments, while the ends of an element are separated by $y = \frac{2S}{p} \pm m$ segments,

where $m = a/p$; segments 1', 3', 5' are therefore shifted with respect to A_2 by an amount $m\beta$, as compared with the relative positions of segments 1, 3, 5 with respect to brush A_1 . The shift is to the right if m is positive (as in the case illustrated), to the left if m is negative. The short-circuiting of these elements can then be shown by drawing two commutators one above the other, as in the upper part of Fig. 233.

Obviously, brushes B_1 and B_2 , and the segments in contact with them, are related to each other in the same way as are A_1 and A_2 . Now B_1 is separated from A_1 by S/p segments, while segment 2' is separated from segment 1 by $\frac{1}{2}(y_1 - 1)$ segments.

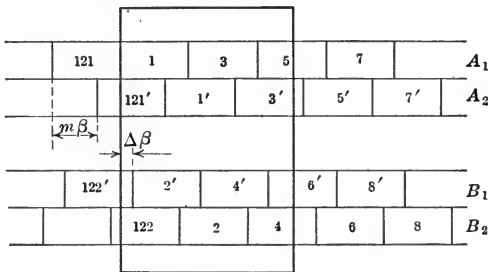

FIG. 233.—Diagram showing coils simultaneously short-circuited—wave winding.

The displacement of segments 2', 4', etc., with respect to B_1 , as compared with that of segments 1, 3, 5 to A_1 , is then

$$\Delta = \frac{S}{p} - \frac{1}{2}(y_1 - 1)$$

and is to the right if Δ is positive (in the winding considered $\Delta = +\frac{1}{6}$), to the left if it is negative. The complete relations are shown in Fig. 233.

If a strip of paper whose width is equal to that of the brush is moved across the fictitious commutators represented by A_1 , A_2 , B_1 and B_2 , it will touch a series of similarly numbered segments and the corresponding coils will be simultaneously short-circuited.

151. Successive Phases of Short-circuit in Coils of a Slot.—

The method described above may be used to investigate the order in which the coils occupying a given slot undergo commutation. Two distinct cases may be distinguished:

1. Coil edges lying in the same radial plane (one above the other) enter and leave short-circuit simultaneously.

2. Coil edges lying in the same radial plane enter and leave short-circuit at different times.

Case 1.—If the coil edges are numbered in accordance with the system described in Art. 73 of Chap. III, and illustrated in Fig. 86, coil sides 1 and 2 of a two-layer winding will occupy the same radial plane, and so also will 3 and 4, 5 and 6, etc. Reference to Figs. 231 and 233 shows, therefore, that if coil sides 1 and 2, 3 and 4, or, in general, any two in the same radial plane, are to enter and leave short-circuit simultaneously, there must be no displacement between the correspondingly numbered commutator segments; in other words, the condition to be satisfied is that

$$\Delta = \frac{S}{p} - \frac{1}{2} (y_1 - 1) = 0$$

or

$$y_1 = \frac{2S}{p} + 1 \quad (16)$$

For example, consider the case of a simplex lap winding having six coil edges per slot, a brush width of $2\frac{1}{2}$ segments, and $\Delta = 0$. With the help of a diagram like Fig. 231, but with Δ made equal to zero, it is readily shown that the successive phases of the short-circuiting of neighboring coils will follow the order shown in parts *a*, *b*, *c*, etc., of Fig. 234, where the shaded coils indicate short-circuit conditions. During a brief interval the condition shown in diagram *c* will exist, that is, all the coil edges in a slot will be simultaneously short-circuited; a little later, as in diagram *e*, six coil edges are again short-circuited, but four are in one slot and two in the next slot.

A study of Fig. 234 shows that when coil edges 1 and 2 leave short-circuit they are subject to the effect of mutual induction from the simultaneously short-circuited coils 3, 4, 5 and 6, all of which occupy the same slot. When coils 3 and 4 leave short-circuit they are subject to the mutual induction of coils 5 and 6, which are in the same slot, and of coils 7 and 8, which are in the next slot; obviously, because of this separation of the short-circuited group of coils, the inductive effect upon coils 3 and 4 will be smaller than in the case of coils 1 and 2. Similarly, when

coils 5 and 6 leave short-circuit they are acted upon by the mutual induction due to the simultaneously short-circuited coils 7, 8, 9 and 10, all of which are in the slot adjacent to that occupied by 5 and 6, hence the inductive effect upon these two coils is still less than in the case of coils 3 and 4. The commutating conditions are, therefore, not the same in all of the winding elements, and their short-circuit current curves will have different forms.

An additional disturbing feature arises from the fact that when the successive coils of a slot, as 1-2, 3-4, 5-6, of Fig. 234 break contact with the brush, they are not identically situated with respect to the adjacent pole tip, consequently the e.m.fs. generated in

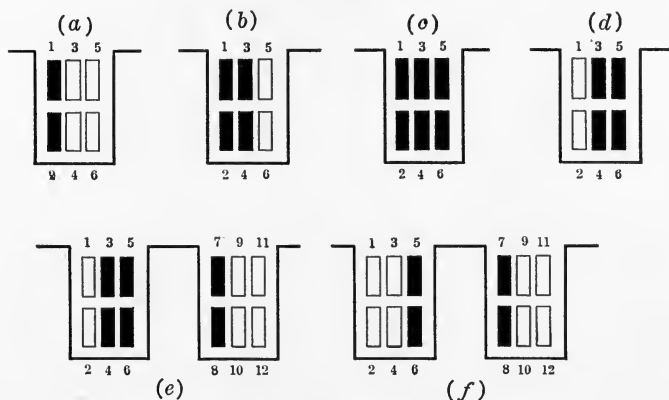

FIG. 234.—Successive phases of short-circuit in adjacent coils, $\Delta = 0$.

each of them during the final stage of the short-circuit (by cutting through the fringing field) will be different. This is due to the fact that the successive commutator segments are evenly spaced, while the coils, being grouped in slots, are not. Thus, in Fig. 234, coils 1 and 2 are ahead of 3 and 4, etc., with respect to the direction of rotation, and their short-circuit terminates when they are in a weaker field than that which acts upon 3 and 4 when the latter leave short-circuit. Similarly, coils 5 and 6 leave short-circuit when they are subjected to the action of a still stronger field than that which acts upon 3 and 4. If, therefore, the commutating e.m.f. acting upon coils 1 and 2 is just sufficient to overcome the e.m.f. of self- and mutual-induction therein, it will be more than sufficient to balance the smaller inductive e.m.f.

in 3 and 4, and much too great in coils 5 and 6. In the latter coils there will be a condition of overcommutation, and under these circumstances every third commutator segment may become blackened because of the possible excessive current density. In order that there may be no marked difference between the field intensities acting upon the various coils of a slot while they are undergoing commutation, the angle subtended by a slot should be small. For this reason the number of slots per pole should not be less than 12, and preferably greater than 12, and the angle subtended between the edges of a brush should not exceed one-twelfth of the angle from center to center of the poles.¹

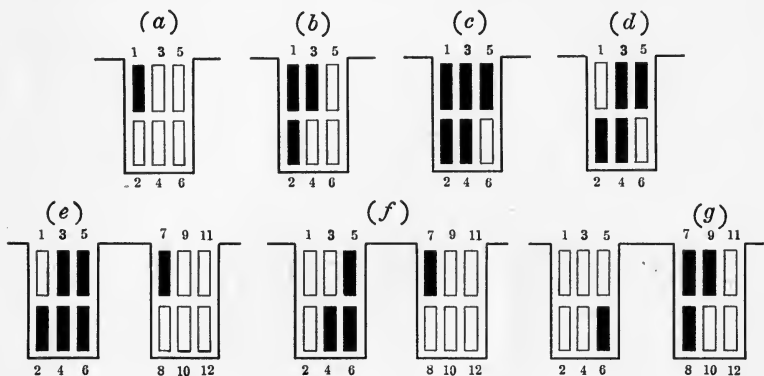

FIG. 235.—Successive phases of short-circuit in adjacent coils, $\Delta = 1$.

The order of commutation illustrated in Fig. 234 can occur only in full-pitch windings, since it is in such windings that the back pitch, y_1 , is made nearly equal to $2S/p$. Chord windings (fractional pitch) are, therefore, characterized by the condition $\Delta \leq 0$.

Case 2.—It follows from the above analysis that the second case arises when $\Delta \leq 0$. An interesting variation of this case occurs when $\Delta = 1$, that is, when

$$y_1 = \frac{2S}{p} - 1 \tag{17}$$

Thus, if a winding has pitches that satisfy equation (17) and is arranged so that each slot contains six coil edges, the brush

¹ Gray, Electrical Machine Design.

width being $2\frac{1}{2}$ commutator segments, the order of commutation of adjacent coils will be as shown in Fig. 235. In this particular case, pairs of coils, like 2 and 3, 4 and 5, etc., enter and leave short-circuit simultaneously.

152. Selective Commutation in Wave Windings.—A study of the simplex wave winding shown in Fig. 81 (p. 93) will show that the several brushes of one polarity are connected to each other not only by an external conductor but also through the winding by way of the coils that they short circuit. The figure also shows that the resistances of these internal paths are not equal because of the varying areas of brush contact; further, the short-circuited coils are not at any instant identically located with respect to the fringing fields through which they are moving, hence the e.m.fs. generated in them by rotation through the field, though small, are not the same in any two of

them. Both of these facts are responsible for an unequal division of the total armature current between the several brushes. The unequal components of the total current shift from brush to brush in cyclical order, in such a way that Kirchhoff's laws are continuously satisfied. This shifting of the current values at the brushes in the case of wave windings is called selective commutation.

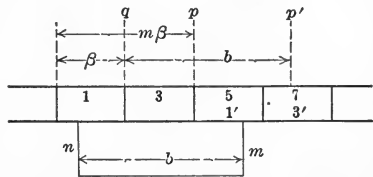

FIG. 236.—Diagram showing duration of short-circuit.

153. Duration of Short-Circuit.—In the case of a simple ring winding the duration of short-circuit is simply the time required for a given point on the commutator to move through an arc equal to the width of a brush. But it will be seen from Figs. 231 and 233 that this simple relation does not hold in lap and wave windings, since a coil is short-circuited only when similarly numbered segments are simultaneously touched by the brush. These segments being displaced with respect to each other, the time of short-circuit may be either greater or less than in a ring winding.

Consider the case of a multiplex lap winding, Fig. 236 (drawn to represent a duplex winding); the distance between corresponding edges of similarly numbered segments will be $m\beta =$

$\frac{a}{p}\beta$, where β is the width of a segment. Short-circuit of coil 1 will endure while the edge m of the brush moves from position p until edge n reaches q . When n is at q , m will be at p' , hence the short-circuit exists over the distance from p to p' , which equals

$$b - (m\beta - \beta) = b + \beta \left(1 - \frac{a}{p}\right)$$

The time of short-circuit is then

$$T = \frac{b + \beta \left(1 - \frac{a}{p}\right)}{v_c} \quad (18)$$

where v_c is the peripheral velocity of the commutator.

An exactly similar result is obtained in the case of wave windings where the number of brush sets equals the number of poles. If one or more pairs of brush sets are omitted, the necessary correction can be applied by remembering that $m\beta$, Fig. 233, is the displacement corresponding to the distance between a given brush and the next brush of the same polarity. Therefore, if some of the brushes are removed, the term $m\beta = \frac{a}{p}\beta$ in the above equation for T must be multiplied by the number of double pole pitches in the region from which the brushes have been omitted.

In simplex lap windings $a/p = 1$, hence $T = b/v_c$, or the same as in a ring winding. T is less than this in multiplex lap windings. In wave windings, on the other hand, T is greater than in a ring winding, other things being equal, since $a/p < 1$.

154. Simultaneous Commutation of Several Coils.—Effect of Wide Brushes.—When the brush width is equal to or less than that of a commutator segment, sparkless commutation generally requires the satisfaction of the condition $R_b T/L > 1$. F. W. Carter has shown¹ that the same condition, in somewhat modified form, also holds when several coils are short-circuited simultaneously, that is, when the brush spans several segments, as in the preceding sections.

Consider the case of a ring winding in which two coils are simultaneously short-circuited, as in Fig. 237, the coefficients

¹ Electrical World, Vol. LV, p. 804, March, 1910.

of self- and mutual-induction of the two coils being L and M , respectively. Then, neglecting the ohmic drops in the connecting leads, the differential equations that determine the currents in the coils become (see Art. 143),

$$L \frac{di_1}{dt} + M \frac{di_2}{dt} + i_1 R_c + (i_0 + i_1) \frac{R_b}{x} - (i_2 - i_1) \frac{R_b}{x_1} + E_{c1} = 0 \quad (19)$$

$$L \frac{di_2}{dt} + M \frac{di_1}{dt} + i_2 R_c + (i_2 - i_1) \frac{R_b}{x_1} - (i_0 - i_2) \frac{R_b}{1 - x - x_1} + E_{c2} = 0 \quad (20)$$

where $x_1 = \beta/b$ and x is a linear function of the time, such that $x\beta$ is the brush overlap on the receding segment. Evidently,

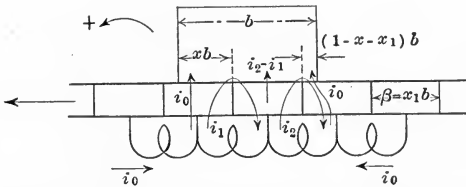

FIG. 237.—Current paths, several coils simultaneously short-circuited.

$$1 - x = \frac{t}{T}$$

$$\frac{dx}{dt} = -\frac{1}{T}$$

and since

$$\frac{di}{dt} = \frac{di}{dx} \cdot \frac{dx}{dt} = -\frac{1}{T} \frac{di}{dx}$$

the above equations may be written

$$\frac{L}{T} \frac{di_1}{dx} + \frac{M}{T} \frac{di_2}{dx} = i_1 R_c + R_b \left[\frac{i_0 + i_1}{x} - \frac{i_2 - i_1}{x_1} \right] + E_{c1} \quad (21)$$

$$\frac{L}{T} \frac{di_2}{dx} + \frac{M}{T} \frac{di_1}{dx} = i_2 R_c + R_b \left[\frac{i_2 - i_1}{x_1} - \frac{i_0 - i_2}{1 - x - x_1} \right] + E_{c2} \quad (22)$$

The expression $\frac{i_0 + i_1}{x}$ is a measure of the current density at the receding segment, and the condition to be satisfied is that this shall not approach infinity as x approaches zero; at the end of

the commutation period $i_1 = -i_0$ and $x = 0$, so that the ratio becomes $0/0$, and this must remain finite. Assume now that the current $(i_0 + i)$ can be expressed as the sum of a series of ascending powers of x (or of the time); then the ratio $\frac{i_0 + i}{x}$ will remain finite if there are no powers of x less than the first. If there are any powers less than the first, both sides of equation (21) will become infinite. Let the lowest power be x^α , so that as x approaches zero, terms involving higher powers become negligible and $i_0 + i_1 = Ax^\alpha$ and $\frac{di_1}{dx} = A\alpha x^{\alpha-1}$. Also, if current i_2 is represented by the same short-circuit curve as i_1 , and therefore analytically by the same equation but with a shift of the x coordinates, $\frac{di_2}{dx} = Bx^{\alpha-1}$ for small values of x .

Substituting these values in (21), and (22) and transposing

$$\left(\frac{L}{T}A\alpha + \frac{M}{T}B - AR_f\right)x^{\alpha-1} = i_1R_c - R_b\frac{i_2 - i_1}{x_1} + E_{c1} = \text{a finite quantity} \quad (23)$$

and

$$\left(\frac{L}{T}B + \frac{M}{T}A\alpha\right)x^{\alpha-1} = i_2R_c + R_b\left[\frac{i_2 - i_1}{x_1} - \frac{i_0 - i_2}{1 - x - x_1}\right] + E_{c2} = \text{a finite quantity} \quad (24)$$

If α were less than unity, $x^{\alpha-1}$ would approach infinity as x approaches zero, hence to preserve the finite value of the left-hand terms we must have

$$\frac{L}{T}A\alpha + \frac{M}{T}B = AR_b \quad (25)$$

and

$$\frac{M}{T}A\alpha + \frac{L}{T}B = 0 \quad (26)$$

Eliminating A and B between these two equations

$$\alpha = \frac{R_b T}{L^2 - M^2}$$

But it was pointed out above that if infinite current density is to be avoided, α must be greater than unity, hence

$$\frac{R_b T}{\frac{L^2 - M^2}{L}} > 1 \tag{27}$$

is the condition to be satisfied. In this inequality the term $\frac{L^2 - M^2}{L}$ takes the place of L in the discussion covering the case of a single coil. Proceeding in a similar manner, Carter has shown that in general

$$\frac{R_b T}{\Lambda} > 1 \tag{28}$$

where

$$\Lambda = \frac{\begin{vmatrix} L_1 & M_{12} & M_{13} & \dots & M_{1n} \\ M_{21} & L_2 & M_{23} & \dots & M_{2n} \\ \dots & \dots & \dots & \dots & \dots \\ \dots & \dots & \dots & \dots & \dots \\ M_{n1} & M_{n2} & M_{n3} & \dots & L_n \end{vmatrix}}{\begin{vmatrix} L_2 & M_{23} & M_{22} & \dots & M_{2n} \\ M_{32} & L_3 & M_{34} & \dots & M_{3n} \\ \dots & \dots & \dots & \dots & \dots \\ \dots & \dots & \dots & \dots & \dots \\ M_{n2} & M_{n3} & M_{n4} & \dots & L_n \end{vmatrix}} \tag{29}$$

When more than two coils are simultaneously short-circuited, the general differential equation takes the form

$$L \frac{di_1}{dt} + \Sigma M_x \frac{di_x}{dt} + \text{ohmic drops} + \text{commutating e.m.f.} = 0$$

where $\frac{di_x}{dt}$ is the rate of change of current in one of the coils, x .

If the commutation were linear in all the coils, $\frac{di}{dt}$ would be constant and equal to $(-2i_0/T)$, hence

$$(L + \Sigma M_x) \frac{di}{dt} + \text{ohmic drops} + \text{commutating e.m.f.} = 0 \tag{30}$$

In other words, when a coil undergoes commutation in the presence of others that are simultaneously short-circuited, the effect is the same as though its self-inductance had been increased.

155. Calculation of the Self-inductance, L , in Slotted Armatures.—The self-inductance of a coil has been shown to be equal to the number of flux linkages per ampere, divided by 10^8 . In the case of an armature coil embedded in a slot, the self-excited flux linking with the coil may be separated into three parts:

1. The flux crossing the slot from wall to wall of the teeth and completing its path through the core, as indicated by ϕ_1 , Fig. 238.

2. The flux passing from tip to tip of the teeth within the space between pole tips, as indicated by ϕ_2 .

3. The flux ϕ_3 linking with the end connections beyond the edges of the core.

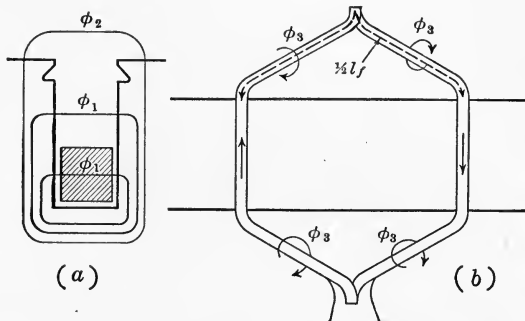

FIG. 238.—Paths of leakage flux surrounding coil.

The number of linkages due to each of these fluxes will now be computed separately.

1. SLOT LEAKAGE FLUX.—Practically without exception the windings of all direct-current machines are arranged in two layers, one side of each coil being in the top layer, the other side in the bottom layer. The magnitude and distribution of the flux is therefore not the same on the two sides of a coil.

a. Coil Edge Occupying the Bottom of a Slot, Fig. 239.—The coil edge contains $z = Z/2S$ conductors, whose total m.m.f. per unit current is $\frac{4\pi}{10}z$ gilberts. The m.m.f. acting upon an elementary tube dx will then be

$$\frac{4\pi}{10} \frac{x}{h_1} z,$$

assuming that the lines of force pass straight across the slot. The flux produced in this elementary path is then

$$d\phi'_1 = \frac{\frac{4\pi}{10} \frac{x}{h_1} z}{\frac{b_s}{l'dx}}$$

where l' is the corrected length of the armature core, all dimensions being in centimeters. The denominator of the above expression represents the reluctance of the air part of the path, that of the iron part being negligible in comparison. This flux links with $\frac{x}{h_1}z$ conductors, hence the number of linkages due to it is

$$\frac{4\pi}{10} \left(\frac{x}{h_1} z\right)^2 \frac{l'dx}{b_s}$$

and this may be reduced to henries by dividing by 10^8 .

$$\therefore dL'_{1b} = \frac{4\pi}{10} \left(\frac{x}{h_1} z\right)^2 \frac{l'dx}{b_s} \times 10^{-8}$$

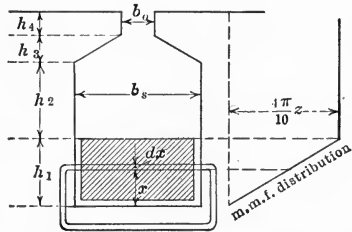

FIG. 239.—Slot leakage flux, coil occupying bottom of slot.

The total number of linkages through the entire depth of the coil is found by integrating in x from 0 to h_1 , or

$$L'_{1b} = \frac{4\pi}{10^9} \frac{z^2 l'}{h_1^2 b_s} \int_0^{h_1} x^2 dx = \frac{4\pi}{10^9} z^2 l' \frac{h_1}{3b_s} \tag{31}$$

Above the coil the m.m.f. has the constant value $\frac{4\pi}{10} z$. Within the region h_2 the flux is uniformly distributed and has the magnitude

$$\phi''_1 = \frac{\frac{4\pi}{10} z}{\frac{b_s}{h_2 l'}}$$

and since it links with all of the conductors,

$$L''_{1b} = \frac{4\pi}{10^9} z^2 l' \frac{h_2}{b_s} \tag{32}$$

In the same way the inductances due to the flux in the regions h_3 and h_4 are

$$L'''_{1b} = \frac{4\pi}{10} z \frac{z}{b_0 + b_s} \times 10^{-8} = \frac{4\pi}{10^9} z^2 l' \frac{2h_3}{b_0 + b_s} \quad (33)$$

and

$$L^{IV}_{1b} = \frac{4\pi}{10^9} z^2 l' \frac{h_4}{b_0} \quad (34)$$

The total inductance due to slot leakage is

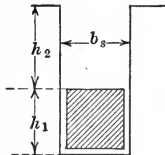

$$L_{1b} = L'_{1b} + L''_{1b} + L'''_{1b} + L^{IV}_{1b} = \frac{4\pi}{10^9} z^2 l' \left(\frac{h_1}{3b_s} + \frac{h_2}{b_s} + \frac{2h_3}{b_0 + b_s} + \frac{h_4}{b_0} \right) \quad (35)$$

In the case of straight slots, Fig. 240a, this reduces to

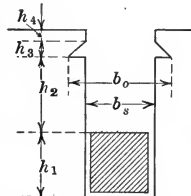

$$L_{1b} = \frac{4\pi}{10^9} z^2 l' \left(\frac{h_1}{3b_s} + \frac{h_2}{b_s} \right) \quad (36)$$

and with the shape of slot Fig. 240b it becomes

$$L_{1b} = \frac{4\pi}{10^9} z^2 l' \left(\frac{h_1}{3b_s} + \frac{h_2}{b_s} + \frac{2h_3}{b_0 + b_s} + \frac{h_4}{b_s} \right) \quad (37)$$

FIG. 240.—Coil occupying straight slots.

b. Coil Edge Occupying the Top of a Slot, Fig. 241.—Using the same methods as in case *a*, the resulting expressions for L_{1t} are identical with those for L_{1b} except that h_2 is replaced by h'_2 . The total inductance of the coil due to slot leakage is then

$$L_1 = L_{1b} + L_{1t}, \quad (38)$$

or less than twice L_{1b} .

2. TOOTH TIP LEAKAGE FLUX.—Assume that the lines of force from tip to tip of teeth are made up of a straight portion b_0 , and of two quadrants of circles, as in Fig. 242. The flux in an elementary path dx is

$$d\varphi_2 = \frac{\frac{4\pi}{10} z}{b_0 + \pi x} l' dx$$

hence the total inductance for both sides of the coil is

$$L_2 = 2 \times \frac{4\pi}{10^9} z^2 l' \int_0^{\frac{1}{2}(\tau - b)} \frac{dx}{b_0 + \pi x} = \frac{4\pi}{10^9} z^2 l' \times 1.46 \log_{10} \left[1 + \frac{\pi(\tau - b)}{2b_0} \right] \quad (39)$$

The expression $(\tau - b)$ represents the distance between pole tips, and the superior limit of the integral is taken to be half of this amount on the assumption that the coils undergoing commutation are approximately midway between pole tips. Values of L_2 calculated by the above equation will be somewhat too large because no account has been taken of the effect of neighboring slot openings in reducing the flux.¹

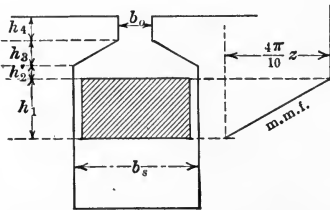

FIG. 241.—Coil occupying top of slot.

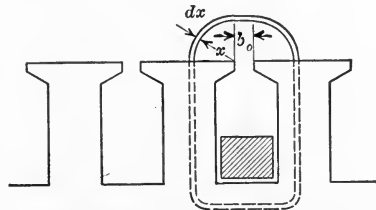

FIG. 242.—Tooth-tip leakage.

3. END CONNECTION LEAKAGE FLUX.—Various approximate formulas have been developed for calculating the inductance due to the end connections.

Niethammer² gives

$$L_3 = z^2 l_f \left[0.4 \log_{10} \left(\frac{l_f}{s} \right) - 0.1 \right] \times 10^{-8} \quad (40)$$

where s is the diagonal of the rectangular coil section (including insulation between turns) and l_f (see Fig. 238b) is the total free length per element.

¹ The limit of integration used in the above equation has been checked by numerous tests, and gives results that agree fairly well with actual measurements. Arnold (*Die Gleichstrommaschine*) uses the entire pole pitch as the superior limit; Gray (*Electric Machine Design*) uses only one tooth width.

² *Elektrische Maschinen Apparate u. Anlagen*, 1, p. 139. Stuttgart, 1904.

Arnold¹ gives

$$\begin{aligned} L_3 &= z^2 l_f \left[0.46 \log_{10} \left(\frac{1/2 l_f}{d_s} \right) - 0.092 \right] \times 10^{-8} \\ &= z^2 l_f \left[0.46 \log_{10} \left(\frac{l_f}{d_s} \right) - 0.23 \right] \times 10^{-8} \end{aligned} \quad (41)$$

where d_s is the diameter of a circle whose circumference equals the perimeter of the coil section including the insulation between turns (see Fig. 243); *i.e.*,

$$d_s = \frac{2(a+b)}{\pi}$$

Hobart calculates the end-connection leakage on the basis of a flux of 0.8 lines per ampere-conductor per cm. of free length.

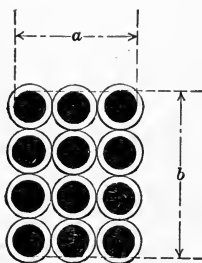

FIG. 243.—Cross section of coil.

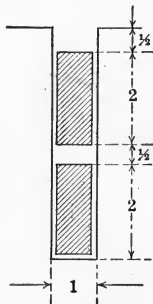

FIG. 244.—Relative slot dimensions, particular case.

The total inductance of a winding element is the sum of the inductances due to the several parts of the leakage, or

$$\begin{aligned} L &= L_1 + L_2 + L_3 = \\ &= \frac{4\pi}{10^9} z^2 l_f' \left[\left(\frac{2h_1}{3b_s} + \frac{h_2 + h_2'}{b_s} + \frac{4h_3}{b_o + b_s} + \frac{2h_4}{b_0} \right) + \right. \\ &\quad \left. 1.46 \log_{10} \left(1 + \frac{\pi}{2} \frac{\tau - b}{b_0} \right) \right] + \frac{z^2 l_f}{10^8} \left[0.4 \log_{10} \frac{l_f}{s} - 0.1 \right] \end{aligned} \quad (42)$$

Parshall and Hobart have published² the results of measurements of the inductance of armature coils of commercial machines from which they deduce that, on the average, the flux linked with the coils is at the rate of 4 c.g.s. lines per ampere-conductor

¹ Die Gleichstrommaschine, Vol. I, p. 376, 2nd ed.

² Electric Generators, 1900.

per cm. of "embedded" length of wire (10 lines per inch), and 0.8 c.g.s. lines per ampere-conductor per cm. of "free" length (2 lines per inch). These values check fairly well with the results of the foregoing formulas when customary dimensions are inserted. Thus, consider a machine with straight open slots whose ratio of depth to width is 5:1 (Fig. 244) and in which $\frac{\tau - b}{b_0}$ is approximately 10, which is equivalent to about five slots in the space between poles.

Taking $z = 1$ and $l' = 1$ cm.,

$$L_{1b} = \frac{4\pi}{10} (2\frac{2}{3} + 3) \times 10^{-8}$$

$$L_{1t} = \frac{4\pi}{10} (2\frac{2}{3} + 1\frac{1}{2}) \times 10^{-8},$$

or an average of $\frac{4\pi}{10} (2\frac{2}{3} + 1\frac{3}{4}) \times 10^{-8} = 3.05 \times 10^{-8}$. The value of L_2 for one side of the coil, with $z = 1$ and $l' = 1$, is

$$\frac{4\pi}{10} \times 0.73 \log_{10} [1 + 15.7] \times 10^{-8} = 1.11 \times 10^{-8}$$

or a total of 4.16×10^{-8} henries, corresponding to 4.16 lines per ampere-conductor per cm. of length. Parshall and Hobart's method is rapid and simple, but it is open to the objection that the designer must exercise great discretion in selecting the proper unit value of flux to fit the dimensions of his machine.

156. Calculation of the Mutual Inductance, M .—The mutual inductance of two coils is equal to the number of flux linkages with one of them when a current of 1 ampere flows through the other, divided by 10^8 .

The previous discussion of the simultaneous short-circuiting of several coils indicates that there are two cases to be considered: one in which the coils in question occupy the same slot, the other in which they lie in different slots.

1. COILS OCCUPYING THE SAME SLOT.—In this case two distinct conditions are possible: (a) the coil edges lie side by side; (b) the coil edges lie one above the other, or one in the top layer, the other in the bottom layer.

(a) It is clear that if the coil edges lie side by side in the slots,

and therefore also throughout their entire lengths, there is no great error in writing

$$M = L$$

(b) Since the coil edges are in different layers, the end connections run in opposite directions, hence the mutual inductance is due only to the slot and tooth-tip fluxes.

In Fig. 245 the cross-hatched areas represent the two sides of a coil. On the left-hand side the inducing coil is at the bottom of the slot and exerts a m.m.f. of $\frac{4\pi}{10}z$ gilberts per ampere on the elementary tube dx ; the slot flux linkages are

$$\int_0^{h_1} \frac{4\pi}{10} \frac{z}{b_s} \left(z \frac{x}{h_1} \right) + \frac{4\pi}{10} z^2 l' \frac{h'_2}{b_s} = \frac{4\pi}{10} z^2 l' \left[\frac{h_1}{2b_s} + \frac{h'_2}{b_s} \right]$$

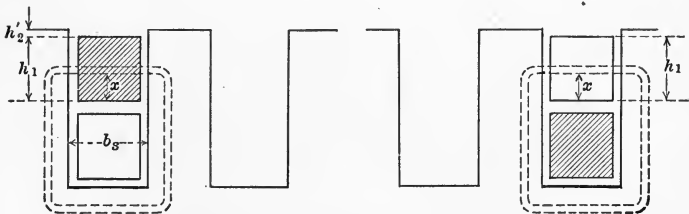

FIG. 245.—Flux leakage paths, mutual inductance.

On the right-hand side, the slot flux linkages are

$$\int_0^{h_1} \frac{4\pi}{10} \left(z \frac{x}{h_1} \right) \frac{z}{b_s} + \frac{4\pi}{10} z^2 l' \frac{h'_2}{b_s} = \frac{4\pi}{10} z^2 l' \left[\frac{h_1}{2b_s} + \frac{h'_2}{b_s} \right]$$

or the same as on the other side of the coil.

The linkages due to the tooth-tip leakage flux are obviously the same as in the calculation of L . Finally, therefore,

$$M = \frac{4\pi}{10^9} z^2 l' \left\{ \left(\frac{h_1}{b_s} + \frac{2h'_2}{b_s} \right) + 1.46 \log_{10} \left[1 + \frac{\pi \tau - b}{2 b_0} \right] \right\} \quad (43)$$

2. COILS OCCUPYING DIFFERENT SLOTS.—(a) *Both Coils in the Same Layer.*—In this case the sides of the coils will be parallel to each other throughout their entire lengths, and the inter-

linked flux will consist of tooth-tip leakage flux along the embedded portion and end-connection flux along the free lengths. Considering the tooth-tip leakage first, coil edge 1, Fig. 246, acts upon paths surrounding coil edge 2 with a m.m.f. of $\frac{4\pi}{10} z$ gilberts per ampere. In the tube dx the flux linkages are then

$$\frac{\frac{4\pi}{10} z}{b_0 + \pi(t + x)} z l' dx$$

and the mutual inductance due to this flux on both sides of the coil is

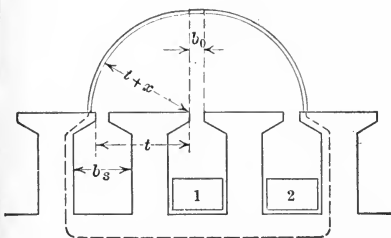

FIG. 246.—Mutual inductance, coils in adjacent slots.

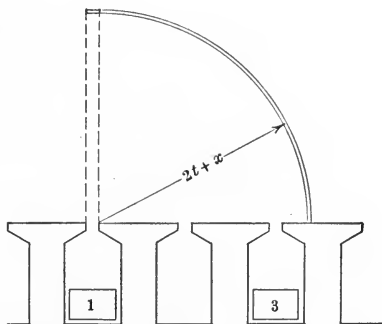

FIG. 247.—Mutual inductance, coils not in adjacent slots.

$$M'_{12} = 2 \times \frac{4\pi}{10^9} z^2 l' \int_0^{\frac{\tau-b}{2}-t} \frac{dx}{b_0 + \pi(t+x)} = \frac{4\pi}{10^9} z^2 l' \frac{4.6}{\pi} \log_{10} \frac{b_0 + \frac{\pi}{2}(\tau-b)}{b_0 + \pi t} \quad (44)$$

This value is somewhat too large since in carrying out the integration continuously to the pole tips the effect of the slot openings is ignored.

The mutual inductance due to end-connection leakage is difficult to estimate. Arnold recommends taking it as one-half of the self-inductance of a single coil. On this basis

$$M''_{12} = z^2 l_f \left[0.2 \log_{10} \left(\frac{l_f}{s} \right) - 0.05 \right] \times 10^{-8} \quad (45)$$

and

$$M_{12} = M'_{12} + M''_{12} \quad (46)$$

When the coils considered are not in adjoining slots, but are placed as in Fig. 247, the above equations become

$$M'_{13} = 2 \times \frac{4\pi}{10^9} z^2 l' \int_0^{\frac{\tau-b}{2} - 2t} \frac{dx}{b_0 + \pi(2t+x)} =$$

$$\frac{4\pi}{10^9} z^2 l' \frac{4.6}{\pi} \log_{10} \frac{b_0 + \frac{\pi}{2}(\tau - b)}{b_0 + 2\pi t} \quad (47)$$

and

$$M_{13}'' = \frac{1}{4} L_3 = z^2 l_f \left[0.1 \log_{10} \left(\frac{l_f}{s} \right) - 0.025 \right] \times 10^{-8} \quad (48)$$

$$M_{13} = M'_{13} + M''_{13} \quad (49)$$

It is not necessary to carry the computation beyond the case shown in Fig. 247 for the reason that the numerical values become relatively small and the brushes are seldom so wide that coils are simultaneously short-circuited in more than three consecutive slots.

(b) *Coils not in the Same Layer.*—In this case the mutual inductances M'_{12} and M'_{13} , due to tooth-tip leakage, remain the same as before; the end-connection leakage reduces to zero because the coils separate and run in opposite directions after leaving the slots. Then

$$M_{12} = M'_{12} = \frac{4\pi}{10^9} z^2 l' \frac{4.6}{\pi} \log_{10} \frac{b_0 + \frac{\pi}{2}(\tau - b)}{b_0 + \pi t} \quad (50)$$

and

$$M_{13} = M'_{13} = \frac{4\pi}{10^9} z^2 l' \frac{4.6}{\pi} \log_{10} \frac{b_0 + \frac{\pi}{2}(\tau - b)}{b_0 + 2\pi t} \quad (51)$$

These values are somewhat too large inasmuch as the effect of the slot openings has been neglected.

157. The Commutating E.M.F.—It has been pointed out that the inequality $\frac{R_b T}{L} > 1$ is not in itself a sufficient criterion of

sparkless commutation, because it is bound up with the relation $E_T < i_0(R + 2R_b)$, the latter condition holding when the brushes are in the neutral zone or only slightly displaced therefrom. In other words, the above relation is of importance in the case of resistance commutation. The same thing is therefore true in regard to the relations which follow from $\frac{R_b T}{L} > 1$, among them the relation $e_{max} < 2$.

If, however, the brushes are given a decided displacement from the neutral so that $E_T > i_0(R + 2R_b)$, it is possible to have the condition $\frac{R_b T}{L} < 1$. This last relation, taken alone, would lead to the conclusion that large values of L and very small values of R_b and T are permissible, but this is naturally incorrect. Obviously, therefore, some other relation must exist which determines the limiting conditions.

An examination of the fundamental differential equation (5),

$$L \frac{di}{dt} + iR + \frac{R_b T}{T - t} (i_0 + i) - \frac{R_b T}{t} (i_0 - i) + E_c = 0$$

shows that there are in general three e.m.fs. concerned in the commutation process: the reactance voltage, $L \frac{di}{dt}$; the commutating e.m.f., E_c ; and the ohmic drops at the transition surfaces. The latter are generally small in comparison with the others, particularly when there is considerable brush lead, hence the conclusion that the commutating e.m.f. should be at all times nearly equal and opposite to the reactance voltage. This is the condition that has already been discussed in Chap. V in connection with armature reaction. It appears, therefore, that while it is desirable to keep the average reactance voltage small, it is even more important to keep the commutating e.m.f. within limits. For instance, consider a machine which is to operate with brushes fixed at a definite angle of lead; at no-load the commutating field will have a certain value and will generate an e.m.f. in the short-circuited coils; this e.m.f. will set up currents in these coils and sparking may result if the e.m.f. so generated is sufficiently high to strike an arc between the brush and the commutator segments as they break contact. It follows, therefore, that the brush must be so placed that at no-load the com-

mutating e.m.f. will be within the sparking limit. When the machine is operating under load conditions, the reactance voltage set up in the short-circuited coils will be opposite in direction to the commutating e.m.f., and the difference between them must again be within the sparking limit.

The field strength in the commutating zone is due to the resultant of the m.m.fs. of the field and armature windings which act in that region. If there were no saturation the commutating field would also be the resultant of the individual fields produced by the field winding and by the armature winding acting separately. In actual calculations this last fact is made use of because of its greater simplicity, and the disturbing effects of saturation must then be allowed for according to the

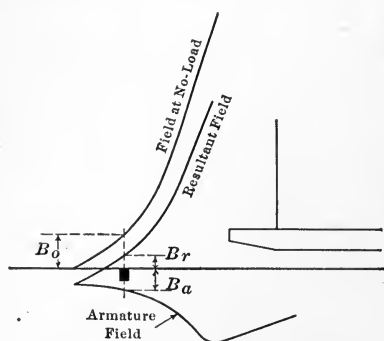

FIG. 248.—Commutating field distribution.

judgment of the designer and his experience with the particular type of machine under consideration. The curves of flux distribution due to the field and armature windings can be determined by the methods described in Chap. V, and in the commutating zone will have the forms indicated in Fig. 248, which represents the case of a generator with a forward lead of the brushes. It will be seen

that the strength of the commutating field decreases with increasing load, if the field excitation remains constant, the change being unfortunately in the wrong direction inasmuch as the commutating e.m.f. should increase with the load. If the armature is magnetically too powerful, or if the brushes are not given a sufficient lead, the commutating e.m.f. may even reverse under load, assuming, as in all the preceding discussions, that there are no special commutating devices present.

In constant-speed generators and motors of the separately excited or shunt type, the commutating field decreases gradually with increasing load, because of armature reaction, in the manner indicated in Fig. 248. The commutating e.m.f., therefore, de-

creases proportionately, so that at the maximum load (generally taken as 25 per cent. overload) it is appreciably less than at no-load; it follows, therefore, that the reactance voltage at maximum load must be considerably less than double the sparking limit in order that the difference between it and the commutating e.m.f. may remain within the sparking limit. In over-compounded generators, on the other hand, the commutating e.m.f. increases with increasing load, so that in machines of this type the reactance voltage at the maximum load may be more than double the sparking limit, without introducing difficulties. In either case, if the excess of the reactance voltage over the commutating e.m.f. at maximum (125 per cent.) load is equal to the commutating e.m.f. at no load, and the latter is within the sparking limit, the two e.m.fs. will exactly neutralize each other at approximately five-eighths of full load, and the commutation will then be satisfactory.

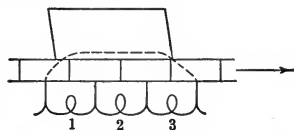

FIG. 249.—Series circuit through short-circuited coils.

The above discussion explains the superior commutating properties of over-compounded or series-wound generators. Furthermore, if the armature cross-magnetizing effect in the commutating zone is neutralized, and a commutating field is set up such that it increases proportionally with the load, the reactance voltage can be exactly balanced at all loads and ideal commutating conditions will result. These effects can be secured by the use of *interpoles* or *commutating* poles, which are placed midway between the main poles and excited by the armature current (see Chap. IX).

In the case of a wide brush short-circuiting several coils, the commutating e.m.fs. evidently act in series through the brush. Thus, in Fig. 249, the brush short-circuits coils 1, 2 and 3 simultaneously, and the sum of the e.m.fs. generated in them by the commutating field acts through the brush as indicated by the dashed line. At no-load this sum must not exceed the sparking limit. Referring to the symbols used in Fig. 248, the magnitude of the commutating e.m.f. at no load, per element, is

$$E_{co} = \frac{Z}{2S} l' v B_0 \times 10^{-8} \quad (52)$$

where B_0 is the average strength of field in the commutating zone, $Z/2S$ is the number of turns per element, and v is the peripheral velocity in cm./sec. This assumes that the coils are of full pitch, so that both sides are at the same time cutting fields of equal intensity. In the case of fractional pitch windings it is necessary to add algebraically the unequal e.m.fs. generated in each side of the coil. Under load conditions the commutating e.m.f. per element becomes

$$E_{cl} = \frac{Z}{2S} l'v (B_0 - B_a) \times 10^{-8} \quad (53)$$

with similar reservations concerning chorded windings. If now n_{sc} is the number of coils simultaneously short-circuited by the brush, we have the relation

$$\Sigma E_{c_0} = n_{sc} \frac{Z}{2S} l'v B_0 \times 10^{-8} < 12 \text{ to } 18 \text{ volts} \quad (54)$$

It is evident from these considerations that the value of B_0 , the flux density in the commutating zone, must be sufficiently under control to allow the brushes to be placed in a position which will insure good commutation under all loads. To this end the field strength in the neighborhood of the commutating pole tip should shade off gradually instead of abruptly, a condition which can be realized fairly well by making the air-gap at the pole tips longer than it is under the central part of the pole shoes.

158. Pulsations of Commutating Field.—During the period of commutation the rotation of the armature periodically changes the positions of the teeth and slots with respect to the pole shoes, thereby giving rise to peripheral oscillations of the armature flux in the interpolar space. The changing current in the short-circuited coils produces a further pulsation of the flux in this region. There may also be pulsations of the flux as a whole, due to periodic changes in the reluctance of the magnetic circuit if the surface of the teeth presented to the poles does not remain constant. All of these effects are of high frequency and induce in the short-circuited coils e.m.fs. of rapidly changing direction which are superposed upon the main e.m.fs. considered in the preceding sections. They give

rise to saw-tooth notches in the short-circuit current curves. Obviously these pulsations can be reduced by using numerous small slots with few coil edges per slot.

159. Sparking Constants.—The expression

$$e_r = \frac{2i_0}{T} L$$

which has been shown to be of considerable importance can be put into another form involving the principal design constants of the machine, and may therefore be used as a check upon the magnitudes of the constants selected before the design has proceeded too far. Thus, it has been shown that

$$T = \frac{b + \beta \left(1 - \frac{a}{p}\right)}{v_c}$$

and

$$L = \frac{4\pi}{10^9} z^2 l' \times F$$

where F is a function of the dimensions of the machine. We have also

$$z = \frac{Z}{2S}$$

and

$$v_c = v \frac{d_{com}}{d}$$

where

v = peripheral velocity of armature

d = diameter of armature

d_{com} = diameter of commutator.

Also,

$$\frac{Zi_0}{\pi d} = q = \text{ampere-conductors per cm. of periphery.}$$

Substituting these values in the expression for e_r , we have

$$e_r = C \frac{Z}{S} l' v q$$

where

$$C = \frac{2\pi\beta F \times 10^{-9}}{b + \beta \left(1 - \frac{a}{p}\right)}$$

The quantity $\frac{Z}{S} l'vq$ may be considered as characteristic of commutating conditions; it has an average value, using metric units, of about 20×10^6 . In English units (l in inches, v in feet per minute, and q in ampere-conductors per inch of periphery) it becomes approximately 40×10^6 .

160. Reaction of Short-circuit Current upon Main Field.—

Let a and b , Fig. 250, represent the initial and final positions of a coil undergoing commutation in a generator. In the a position the coil clearly exerts a demagnetizing magnetomotive force upon the main magnetic circuit, while in the b position the action is a magnetizing one. If commutation takes place, on the average, in the geometrical neutral, and if the short-circuit

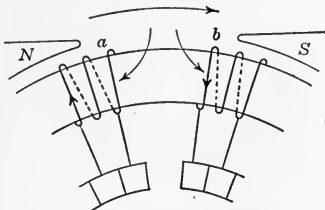

FIG. 250.—Magnetizing action of short-circuited elements.

current curve is symmetrical with respect to the point O (Fig. 218), the demagnetizing and magnetizing effects annul each other. But if the mid-point of the commutation period occurs when the coil is in the geometrical neutral, and the short-circuit current curve is not symmetrical, one or the other of the two effects will preponderate.

Thus, in the case of overcommutation, the current will have the direction of the b position during the greater part of the time of short-circuit, hence there will be a resultant magnetizing action. In case of undercommutation the resultant action will be demagnetizing. Obviously, these statements are to be reversed in the case of a motor.

When a generator is running without load, currents will be set up in the coils short-circuited by the brushes. The direction of the current flow will depend upon the direction of the field in which the coils are moving, and, therefore, upon the direction of displacement of the brushes. With a forward lead of the brushes the current in the short-circuited coils will have the direction shown in the b position, Fig. 250, and will then exert a magnetizing effect; a backward lead of the brushes will evidently result in a demagnetizing action. The magnitude of these no-load short-circuit currents may be sufficiently great

to materially influence the field flux, hence also the experimentally determined open-circuit characteristic.

161. The Armature Flux Theory.—The distorted air-gap flux due to the magnetizing action of the armature current can be thought of as compounded of the fluxes which would be produced by the field and armature m.m.fs. acting separately. Strictly speaking, this is not exactly true when saturation of the iron part of the magnetic circuits exists, but it will serve as a first approximation to the truth. If, then, the brushes are set so that commutation takes place in the geometrical neutral, the short-circuited coils will not be acted upon by the field component of the flux, but the armature flux, being stationary in space, will generate e.m.fs. in them in exactly the same way that the main flux acts upon the conductors under the poles. The state of affairs in a generator will be as shown in Fig. 251. This figure brings out the fact that the e.m.f. generated by the armature flux in the short-circuited coil is in the same direction as

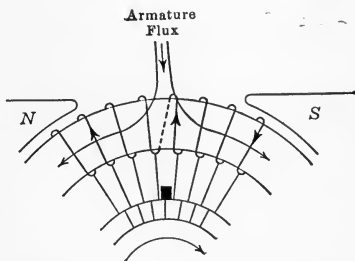

FIG. 251.—Production of armature flux.

the original current flow and therefore tends to prevent the desired reversal of current. Evidently this e.m.f. must be neutralized by an e.m.f. of opposite direction and somewhat greater magnitude in order that there may be a sufficient surplus e.m.f. to effect the reversal. This reversing e.m.f. may be obtained by shifting the brushes until commutation takes place in a sufficiently intense part of the field flux; or the brushes may be kept in the neutral axis and the armature m.m.f. wiped out by the opposing m.m.f. of an interpole or its equivalent (see Chap. IX).

A full treatment of the subject of commutation based on this analysis has been worked out by B. G. Lamme.¹ It has the advantage that it emphasizes the physical phenomena involved in the commutation process. It does not involve the explicit

¹ A Theory of Commutation and Its Application to Interpole Machines, Trans. A.I.E.E., Vol. XXX, Part 3, 1911, p. 2359.

consideration of the e.m.fs. of self- and mutual-induction, though these are implicitly involved in the e.m.fs. generated by cutting the stationary armature flux. For example, in the paper referred to there occurs the following statement:

“According to the usual theory, during the commutation of the coil the local magnetic flux due to the coil is assumed to be reversed. However, in the zone in which the commutation occurs, certain of the magnetic fluxes may remain practically constant in value and direction during the entire period of commutation. This is but one instance, of which there are several, to show where there is apparent contradiction of fact in the usual mathematical assumptions made in treating this problem.”

The reversal of the self-excited flux which is responsible for the e.m.f. of self-induction is not, however, a mere mathematical abstraction in the inductance theory; for while this flux does reverse *with respect to the coil*, it does not reverse its direction in space as will be clear from Fig. 250, which shows a short-circuited coil in two successive positions, before and after the reversal of the current. This is a consequence of the motion of the coil. If, however, this self-excited flux is considered as producing the e.m.f. of self-induction, it should be eliminated in the computation of the commutating flux; in other words, the latter is then to be taken as the resultant of the field flux and that part of the armature flux which is due to the armature turns outside of the commutating zone.

PROBLEMS

1. What is the ratio of the energy losses due to brush contact resistance in two machines, which are identical in all respects except that in one of them the commutation is linear and in the other sinusoidal, as indicated in curves *c* and *d* of Fig. 218?

NOTE.—This problem may be solved most simply by plotting a curve showing the variation of contact loss throughout the period of commutation. The energy loss will then be proportional to the area under the curve.

2. Construct a curve showing the variation of current density at a commutator segment, and curves showing the variation of current density at five points equally spaced along the brush arc, for the case of a machine which has a brush covering $2\frac{1}{2}$ commutator segments and in which the short-circuit current curves are sinusoidal.

3. The armature of a 6-pole machine has a simplex lap winding of 546 conductors arranged in 91 slots; the commutator has 273 segments and has a diameter of 42 cm., and the brush contact arc is 1.2 cm. Construct dia-

grams showing the sequence of commutation in the coils occupying two adjacent slots, (a) assuming full-pitch windings, (b) assuming a pitch that is less than full pitch by one slot.

4. The armature of a 10-pole machine has a quintuplex wave winding of 1230 conductors arranged in 205 slots; the commutator has 615 segments and a diameter of 131 cm.; the brush contact arc is 2 cm. Construct diagrams showing the sequence of commutation in the coils occupying two adjacent slots.

5. The machine of Problem 3 runs at a speed of 430 r.p.m. and that of Problem 4 runs at 94 r.p.m. Find the duration of the period of short-circuit in each case.

6. The diameter of the armature of Problem 3 is 59.1 cm., the total length of armature core is 32 cm., and the slots are 1 cm. wide by 2.9 cm. deep; each conductor has a cross-section measuring 0.18 by 1.2 cm. The thickness of the insulation at the bottom of the slot is 0.1 cm., and the thickness of the insulation between the top and bottom layers is 0.12 cm. Assuming that the total length of the conductors of an element is twice the length of core plus three times the pole-pitch, and that the pole arc is 70 per cent. of the pole pitch, find the total inductance of an element, taking into account the mutual induction due to simultaneously short-circuited elements.

7. An armature has semi-closed circular slots of radius r cm., as shown in the right-hand diagram of Fig. 52, p. 64. The opening at the top of the slot is r_1 cm. wide and r_2 cm. deep, the center of the circular slot being $(r + r_2)$ cm. below the periphery. If the slot contains z conductors, distributed uniformly over the cross-section of the circle, what is the inductance due to slot leakage flux, assuming that the lines of force pass straight across the slot (horizontally in Fig. 52)?

CHAPTER IX

COMPENSATION OF ARMATURE REACTION AND IMPROVEMENT OF COMMUTATION

162. Principle of Compensation.—The cross or transverse magnetizing action of the armature current is the primary cause of the field distortion which in turn necessitates the shifting of the brushes and thereby brings into existence the demagnetizing action of the armature. Clearly, then, if the transverse magnetomotive force of the armature were balanced by an equal and opposite magnetomotive force having the same distribution in space, the distortion of the field would be completely eliminated and brush displacement would be unnecessary except, possibly, to assist in commutation. Moreover, if the armature magnetomotive force is overcompensated, there will exist in the neutral zone a component of flux having the proper direction to reverse the current in the short-circuited coils, and the brushes could then be permanently fixed in the geometrical neutral axis.

If the ratio of compensating ampere-turns to armature ampere-turns is unity, nearly complete neutralization of the armature flux will result; if the ratio is slightly greater than unity, there will exist in the commutating zone a reversing flux which increases proportionally with the armature current (unless saturation of the iron of the magnetic circuit sets in) which is precisely the condition necessary to secure good commutation at all loads. In either case, whether the above ratio is unity or greater than unity, the compensating winding must be traversed by the main armature current or a fractional part thereof; consequently the compensating winding is connected in series with the armature, and may or may not be provided with a diverting shunt, as in the case of the series winding of a compound machine.

The problem of compensating armature reaction then consists of two parts; one, the prevention of the field distortion and the consequent elimination of the demagnetizing action of the arma-

ture; the other, the production of a commutating e.m.f. for the purpose of neutralizing the reactance voltage of the short-circuited coils and reversing the current in them. Of these two, the latter is the more important.

163. Compensating Devices.—In a German patent granted to Menges in 1884 there is the first exposition of the principle of compensating armature reaction. The patent specifications call for the use of a stationary compensating winding wound around the armature at the sides of the poles and traversed by the armature current, or a part of it, in such a direction as to oppose the magnetizing action of the armature. Later, in 1892, H. J. Ryan and M. E. Thompson experimented extensively along similar lines and developed the method shown diagrammatically in

Fig. 252 for the case of a bipolar generator. The compensating winding is embedded in slots in the pole faces. The space distribution of the compensating winding being very nearly the same as that of the armature winding, the neutralization of armature reaction is practically complete. Since in the case shown in Fig. 252 the current in the armature conductors is half of the total current, the number of turns in the

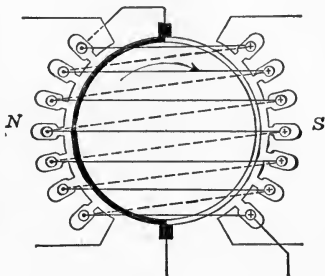

FIG. 252.—Diagram of compensating winding.

compensating winding should be half of the effective number of cross-magnetizing armature turns. In larger multipolar machines the number of compensating turns per pole should be $1/a$ times the armature turns per pole, where a is the number of current paths through the armature.

Fig. 253 illustrates the construction of the field frame of a machine of this type as built by the Ridgway Dynamo and Engine Company. The entire magnetic circuit is built up of sheet steel stampings, the main ring or yoke being clamped between cast-iron frames; the main pole pieces that carry the coils of the shunt winding are bolted to the yoke, and the cores that carry the compensating winding are held by the bolts which pass through the main poles and by the wedges which hold the commutating lugs in position. These wedges also serve to reduce the cross-

section of the magnetic path from pole to pole, and so keep down magnetic leakage.

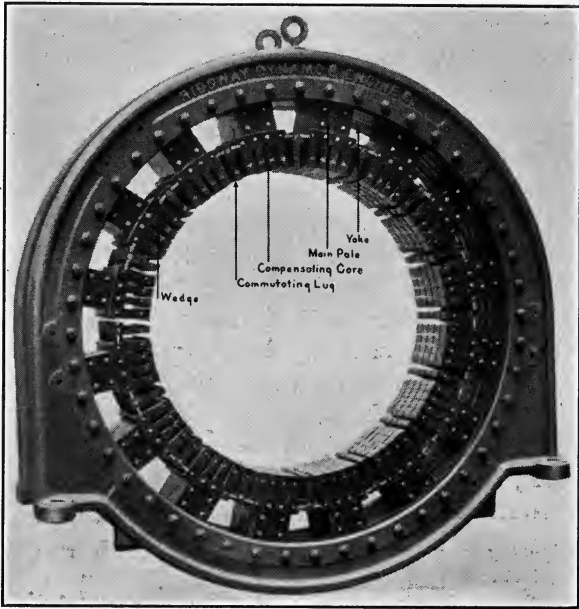

FIG. 253.—Frame of Ridgway generator, showing slotted pole face.

Fig. 254 illustrates diagrammatically a portion of the magnetic circuit of a machine embodying the above device. Under load

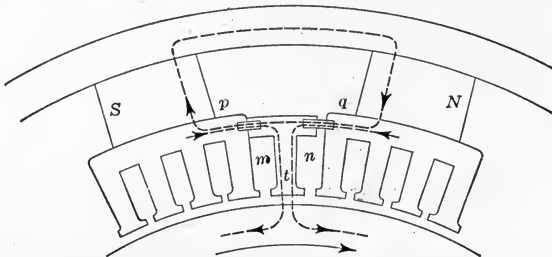

FIG. 254.—Flux paths in poles of compensated machine.

conditions the magnetomotive force of the compensating winding acts in the directions shown by the dotted lines, assuming generator action and clockwise rotation. Section *q* of the bridge

is acted upon by two m.m.fs. having the same direction, but the flux is not materially increased on account of the initial saturation of the iron; and section p is acted upon by two m.m.fs. of opposite direction. The result is that the central tooth t is acted upon by a resultant m.m.f. which makes it a north pole under the assumed conditions, hence it produces a local field of

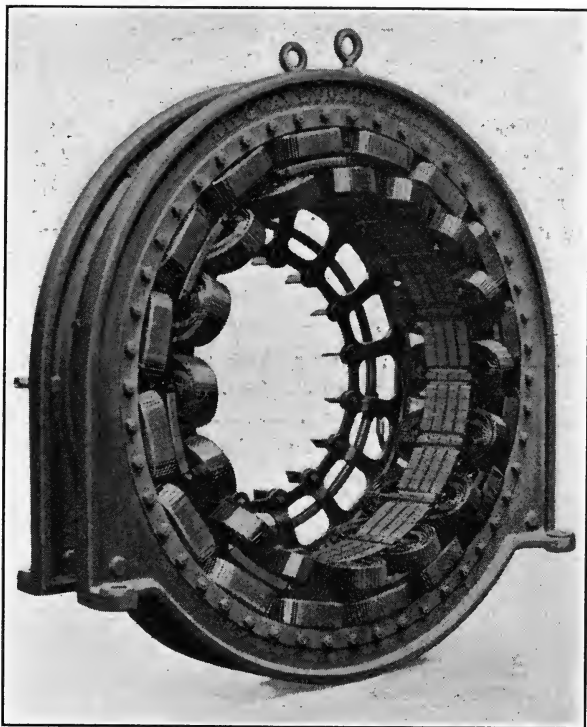

FIG. 255.—Frame of Ridgway generator, coils in place.

the proper direction to assist the reversal of the current in the short-circuited coils. This effect is accentuated by making slots m and n somewhat larger than the others (see also Fig. 253) and winding in them more than the normal number of conductors. The arrangement of the compensating winding and main field winding is shown in Fig. 255.

Closely akin to the Thompson-Ryan device is an arrangement

due to Deri. Instead of using a field frame of the salient pole type with the addition of a slotted ring, the field structure consists of a slotted cylinder wound with two independent sets of coils and concentrically surrounding the armature, as indicated in Fig. 256. The main winding, *M*, produces poles whose axes are indicated by the arrows; the compensating winding, *C*, sets

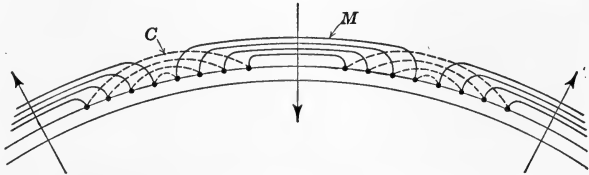

FIG. 256.—Deri's arrangement of main and compensating windings.

up a magnetomotive force acting along axes midway between the poles, and in opposition to the armature m.m.f. The field structure closely resembles the stator of an induction motor, and since the reluctance of the magnetic path is the same along all diametral paths, the compensation can be made complete.

164. Commutating Devices.—The entire prevention of field distortion is not necessary for successful commutation. The

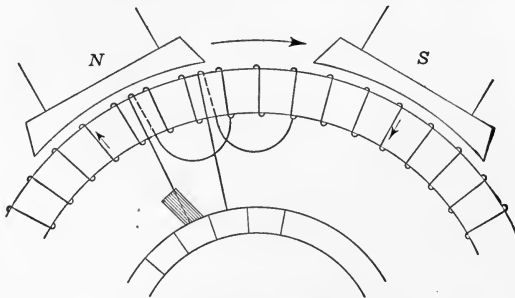

FIG. 257.—Sayers' winding.

principal consideration is to insure the presence of a commutating field of sufficient intensity to generate in the short-circuited coil an e.m.f. large enough to neutralize the reactance voltage.

Thus, in the Sayers winding, Fig. 257, there is no compensation of armature reaction, but the reversing e.m.f. is introduced into the short-circuited coil by an auxiliary winding which is so placed as to cut a part of the main flux during the commuta-

tion period and which, during that interval, is in series with the coil undergoing commutation. At all other times the auxiliary coil is not in circuit. The auxiliary coils are in reality merely extensions of the commutator leads which have been wound around the armature. The main coils are connected to auxiliary coils which lie *behind* them with respect to the direction of rotation so that commutation is not dependent upon the flux density at the leading pole tip, as in the ordinary machine, but upon that at the trailing pole tip; and since the field intensity at the latter increases with increasing current, the commutating e.m.f. increases with it. A limit is set to this automatic adjustment of commutating conditions by the saturation of the trailing pole tip. The Sayers device is of historical rather than practical interest, as is also that of Swinburne.¹ In the latter, small U-shaped electromagnets, Fig. 258, excited by the main current, are placed in the

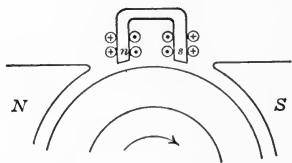

FIG. 258.—Swinburne's commutating device.

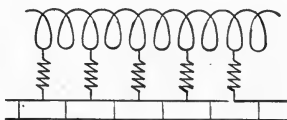

FIG. 259.—High resistance leads to commutator.

neutral zone. Another method that has been used for the prevention of commutation difficulties consists of the insertion in the circuit of the short-circuited coil of an auxiliary resistance which serves to limit the current and, therefore, the energy that must be handled at the brush contact. The simplest method that suggests itself for this purpose is the use of commutator leads of high specific resistance, as indicated in Fig. 259; this arrangement is used in certain types of alternating-current motors. It is, however, open to the serious objection that the main current must flow through a set of these extra resistors with consequent heating and loss of efficiency.

Instead of inserting resistance in the circuit in the above manner, the brushes may be so constructed as to interpose more resistance in the path of the short-circuit current than in that of

¹ Journal Inst. of Electrical Engineers, 1890, p. 106.

the main current, by making them of alternate longitudinal layers of carbon and copper. The copper provides a path of high conductance so far as the main current is concerned, while the short-circuit current must pass transversely through the higher resistance of the carbon and copper in series. It is possible, however, that brushes of this type may fail to operate satisfactorily for the reason that the short-circuit current may pass from one copper layer to the next by way of the commutator surface instead of through the intermediate layer of carbon. A better design, due to Young and Dunn,¹ provides for the final rupture of the short-circuit at an auxiliary carbon brush insulated from the main brush, in the manner indicated in Fig. 260. This has the effect of considerably increasing the resistance of the circuit at the last stage of the commutation process.

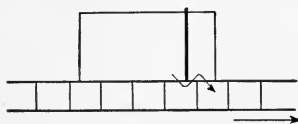

FIG. 260.—Special brush with auxiliary insulated section.

At the present time, however, the device that is used to the practical exclusion of all others, wherever commutating conditions present special difficulties, is the *interpole* or *commutating pole*, the principal features of which are discussed later.

The structural arrangement of the interpole machine is shown in Fig. 65, Chap. II. The magnetomotive force of the interpoles is so adjusted that the m.m.f. of the armature is slightly over-compensated. The final adjustment for sparkless operation is made by varying the air-gap under the interpoles by means of shims, or by means of a shunt around the interpole winding.

165. Commutation in Machines having no Auxiliary Devices.

—It goes without saying that the mechanical construction of the commutator and brush rigging must be such as to insure perfect contact and absence of vibration. The natural period of vibration of the brushes and brush holders should differ from that of any vibration which may possibly be impressed upon them by the motion of the commutator, in order that mechanical resonance may not occur. The copper of the commutator should be of uniform quality so that a true cylindrical surface may be preserved, and the mica insulation between segments should have a rate of wear as nearly as possible the same as that of the copper.

¹ Electrical World, 1905, p. 481.

Reference has already been made in the preceding chapter to the more important magnetic and electrical factors concerned in the commutation process, to which due regard must be paid to insure sparkless operation. For the sake of completeness they are here recapitulated and in addition there is given a summary of the methods adopted to secure them.

1. The summation of the commutating e.m.fs. generated in the coils under a brush must not be greater than 12 to 18 volts, or

$$\Sigma E_{c0} = n_{sc} \frac{Z}{2S} l'vB_0 \times 10^{-8} < 12 \text{ to } 18 \text{ volts.}$$

This equation is based upon the assumption of full-pitch windings; in the case of fractional pitch windings the two sides of a coil undergoing commutation are in fields of unequal strength, sometimes of the same polarity, so that the e.m.fs. generated in them may tend to annul each other. This results in a decrease of the short-circuit e.m.f. At the same time there is a decrease in the demagnetizing action of the armature. Both effects indicate that chording the windings is advantageous, but a distinct limit is set by the fact that in such windings at least one side of the short-circuited coil will lie close to a pole tip where the field intensity changes sharply; this feature greatly restricts the zone through which the brushes may be rocked, and is incompatible with the requirement of a fringing field of gradual slope.

2. The average reactance voltage

$$e_r = \frac{2i_0}{T} L < 2i_0R_b$$

should be less than 1 volt, as determined by the relation $\frac{R_b T}{L} > 1$. The limiting value of e_r is set by the voltage drop at the brush contact, $2i_0R_b$, which is of the order of 1 volt. The harder the grade of carbon used in the brushes the greater will be the drop. Consequently hard carbon should be used where resistance commutation is necessary. Fig. 261 (taken from Gray's Electrical Machine Design) shows the variation of brush contact drop with current density for an average carbon. The tendency toward constant drop with increasing current density is obvious. The contact drop in the direction from commutator

to brush is generally somewhat higher than that in the direction from brush to commutator.

3. The brush width should not be too great, in order to cut down the mutual induction of the simultaneously short-circuited coils. In practice, the brush width seldom exceeds 3.5 times the width of a commutator segment. To secure sufficient contact area to carry the current the axial length of the brushes is adjusted so that the average current density is in the neighborhood of 30 amperes per sq. in. (5 amperes per sq. cm.) for hard carbons and as high as 65 amperes per sq. in. (10 amperes per

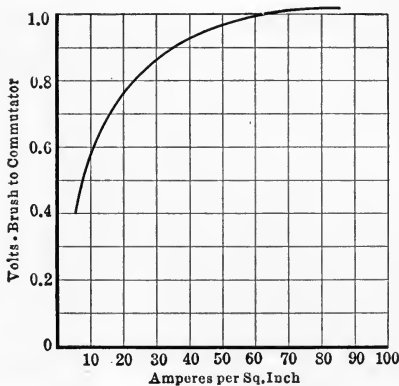

FIG. 261.—Relation between brush drop and current density, average carbon.

sq. cm.) for soft carbons. An average of about 40 amperes per sq. in. is customary. Considerably higher densities are permissible with metal (copper) brushes, up to about 160 amperes per sq. in.

Since the number of simultaneously short-circuited coils is given by

$$n_{sc} = \frac{b}{\beta} \cdot \frac{p}{a}$$

and since the ratio $\frac{b}{\beta}$ is fixed by usual practice at from 2 to 3.5, it follows that p/a must be kept small if special difficulties are encountered. The ratio p/a is a maximum in series (two-circuit) windings, hence if ΣE_{c_0} turns out to be too large the remedy is a series-parallel or full-parallel winding.

4. The inductance of the coils can be kept within limits by reducing the number of turns per element; or conversely, for a given number of armature conductors, by increasing the number of commutator segments. The value of L can also be made small by selecting a relatively short axial length of armature. Both of these considerations point to the desirability of a design in which the ratio of diameter to length of armature core is relatively large. A large number of commutator segments involves a moderate average value of volts per segment, $E \div \frac{S}{p} = \frac{pE}{S}$, which value, in simplex lap windings, should not

exceed 20 volts and should be less than 15 volts, if possible. The maximum difference of potential between adjacent segments in machines of the series types should never exceed 40 volts, otherwise there is the possibility that the machine will "flash over."

The selection of a large diameter carries with it the possibility of using a large number of slots each containing but few coil sides, thereby reducing the mutually inductive action. The presence of numerous armature slots means further that there will be a sufficient number of them between pole tips to cut down oscillations of the commutating flux and minimize pulsations of the flux as a whole.

5. It was shown in Chap. V that in order to prevent the reversal of the commutating field by the distorting action of the armature it is necessary to observe the relation

armature ampere-turns per pole $\bar{\approx}$ 1.1 field ampere-turns per pole,

though in most cases the factor is 0.8 to 0.9 instead of 1.1.

In other words, the main field should be powerful, or "stiff," in comparison with the armature field. Since the armature magnetomotive force acts upon a different path from that subjected to the main field excitation, it is clear that the disturbing effect of armature reaction can be reduced by introducing additional reluctance into the transverse magnetic circuit of the armature. If at the same time those parts of the magnetic circuit which are influenced by both the armature and field excitation are saturated at no-load, the load current will have little effect in producing distortion; the saturation acts, of course, as an increase of reluctance.

The first of the above methods is not as simple as it appears at first sight; the armature magnetomotive force acts upon a path which includes the most important part of the main magnetic circuit, namely the air-gap and the iron parts adjacent

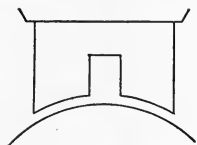

FIG. 262.

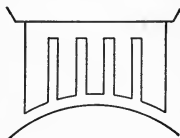

FIG. 263.

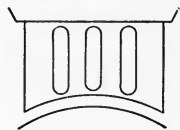

FIG. 264.

FIGS. 262, 263, 264.—Longitudinal slotting of pole cores.

thereto. The addition of reluctance to the path of the armature m.m.f. therefore adds more or less to the reluctance of the main circuit, hence requires more field excitation and increases the cost of the machine. Designs embodying this principle

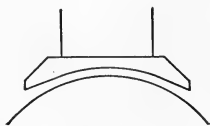

FIG. 265.

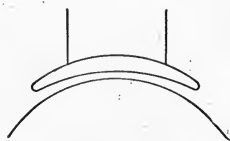

FIG. 266.

FIGS. 265 and 266.—Chamfered and eccentric pole faces.

alone involve a longitudinal slotting of the pole cores, as shown in Figs. 262, 263 and 264. Their effectiveness is open to question inasmuch as the armature flux will tend to pass around behind the slots rather than across them. The most effective

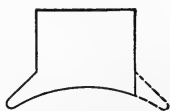

FIG. 267.

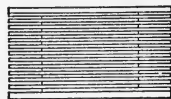

FIG. 268.

FIGS. 267 and 268.—Construction of laminated pole.

designs are those which include both the features of additional reluctance and saturation of the iron; the extra reluctance is usually obtained by chamfering the pole tip, as in Fig. 265, or by making the bore of the pole faces eccentric,

as in Fig. 266. The saturation feature is most important at the trailing tip in the case of generators and at the leading tip in the case of motors; the desired saturation is obtained by using a long thin tip, or, in the case of laminated poles, by using a stamping of the form of Fig. 267, in which case the laminations are built up to the required thickness in such a manner that the projecting tips are alternately on opposite sides; a plan view of the pole face as seen from the armature surface is then like Fig. 268. It is, of course, not necessary that the entire pole be laminated to secure this construction, as the pole shoe alone may be built of stampings and bolted to a solid pole core.

Fig. 269 illustrates the pole construction of a Lundell generator which embodies a number of these features; it is, however, only adapted to machines that run in one direction.

Saturation of the armature teeth acts in the same way as saturation of the pole tips. The tooth density is therefore purposely made high, often as high as 140,000 lines per sq. in. (21,000 per sq. cm.). This is particularly true in the case of motors which are required to operate with the brushes fixed at the geometrical neutral, as in railway motors.

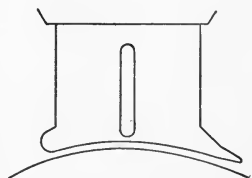

FIG. 269.—Pole of Lundell generator.

6. The requirement of a fringing commutating field of gradually changing intensity is met by properly shaping the tips of the pole shoes. The length of the air-gap at the pole tips can be computed from the equation

$$\delta' = \frac{(1.25 \text{ to } 2) \left[\frac{\beta Z i_a}{360a} - 2AT_t \right]}{1.6 B_g}$$

as shown in Chap. V.

166. Commutating Poles.—Commutating poles, or interpoles, have been extensively adopted for the improvement of commutation in generators and motors in which sparkless operation would be difficult or impossible of attainment under ordinary conditions. Examples of such machines are turbo-generators and shunt motors which are required to have a wide

range of speed, as discussed in Chaps. VI and VII. Interpoles are also extensively used in series railway motors. Interpoles obviate the necessity for the various expedients commonly employed in ordinary machines. They are superior to forms of construction involving compensating windings in the pole faces because of their greater simplicity.

Complete neutralization of the armature flux is not possible by the use of interpoles for the reason that the space distributions of the m.m.fs. of armature and interpoles are different. This is not objectionable, however, since the essential feature is the production, in the commutating zone only, of a reversing flux of proper intensity. The flux distribution outside of this zone is of minor importance.

The presence of interpoles increases the magnetic leakage of the main poles, the calculation of the leakage factor being made in the manner outlined in Chap. IV. To reduce the leakage to a minimum, both the breadth and length of the interpoles should be kept as small as possible, and the span of the main poles made smaller than in ordinary machines; the ratio of pole arc to pole pitch is usually between 0.60 and 0.65, instead of 0.70. The span of the interpole should be equal to, or slightly greater than, the distance moved over by a slot while the coils in it are undergoing commutation. The axial length of the interpole can be made less than that of the main poles, for it is immaterial in what portion of the coil the neutralizing e.m.f. is generated; but if the interpole is shortened, the intensity of the field under it must be greater than under a pole of full length in the ratio of full length to actual length, with due regard to fringing of the flux.

167. Winding of Commutating Poles.—The calculation of the winding to be placed on the commutating poles presents no special difficulties. It is necessary to provide a sufficient number of ampere-turns to balance those of the armature and to supply the m.m.f. required to drive the commutating flux through the transverse path n, s , Fig. 270, taking into account the m.m.f. supplied by the main poles, N, S , in those parts of the path of the lines of induction which are common to both magnetic circuits. The figure represents a bipolar generator revolving in the clockwise direction; if the machine were a motor revolv-

ing in the same direction, the polarity of the interpoles would have to be reversed, a condition that would be met automatically upon reversing the current through the armature, since the two windings are in series.

Fig. 270 reveals the fact that the m.m.fs. of the main and commutating poles act in the same direction in two of the four quadrants of the armature core and of the yoke, and in opposite directions in the other two quadrants. If there were no saturation each m.m.f. would produce a proportional flux, in which case the flux in the armature core would be $\frac{\Phi + \Phi_i}{2}$ in two of the

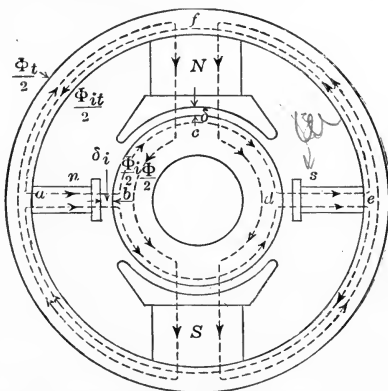

FIG. 270.—Magnetic circuits in interpole machine.

quadrants, and $\frac{\Phi - \Phi_i}{2}$ in the other two, where Φ_i is the working flux produced by the interpole. Similarly, in two of the quadrants of the yoke the flux would be $\frac{\Phi_t + \Phi_{it}}{2}$, and $\frac{\Phi_t - \Phi_{it}}{2}$ in the other two; here $\Phi_t = \nu\Phi$ where ν is the coefficient of dispersion of the main poles, and $\Phi_{it} = \nu_i\Phi_i$ where ν_i is the coefficient of dispersion of the interpoles. The magnitude of the commutating flux Φ_i is given by

$$\Phi_i = B_{ig} b'_i l'_i$$

where B_{ig} , the flux density in the gap under the interpole, is determined by the value of the commutating e.m.f. to be generated,

and b'_i and l'_i are respectively, the corrected breadth and length of the interpole; these corrected lengths are greater than the actual lengths by from 3 to 4 times the air-gap, δ_i , under the interpole. Corresponding to this value of Φ_i and to that of the main flux Φ there will be definite flux densities in each part of the closed magnetic circuit $abcdefa$, and to each flux density there will correspond a definite number of ampere-turns which may be determined from the appropriate B-H curves. Thus, let

AT_{ic} = ampere-turns required by the two interpole cores and shoes

AT_{ig} = ampere-turns for the two interpole air-gaps, δ_i

AT_{it} = ampere-turns for the two sets of teeth opposite the interpoles

AT'_a = ampere-turns for the armature core, b to c

AT''_a = ampere-turns for the armature core, c to d

AT'_y = ampere-turns for the yoke, e to f

AT''_y = ampere-turns for the yoke, f to a

Then, in the closed magnetic circuit, $abcdefa$, the algebraic sum of all the m.m.fs. must be zero, in accordance with Kirchhoff's law. In this circuit there act, in addition to the m.m.fs. listed above, that due to the two interpole windings, AT_i , and that due to the armature, AT_{arm} , where

$$AT_{arm} = \frac{2}{p} \frac{Z}{2} i_a = \frac{Z i_a}{\pi d} \cdot \frac{\pi d}{p} = q\tau$$

$$\therefore AT_i = q\tau + AT_{ic} + AT_{ig} + AT_{it} - AT'_a + AT''_a + AT'_y - AT''_y$$

It follows, then, that the number of turns to be wound on each interpole is $\frac{1}{2} \frac{AT_i}{i_a}$, provided the interpole coils are not shunted.

A larger number of turns may be used if a diverting shunt is placed across the interpole winding.

The above discussion applies directly to the bipolar machine of Fig. 270, and with obvious modifications applies also to multipolar machines.

168. Effect of Commutating Poles upon Coil Inductance.—

The presence of commutating poles causes an increase in the inductance of the short-circuited coils under them. In the expression $L = L_1 + L_2 + L_3$ (Chap. VIII), the term L_2 , due

to tooth-tip leakage, is affected. Its value may be computed as follows:

Suppose the center of the slot containing a coil edge to be a distance x cm. from the center of the commutating pole of corrected breadth b'_i , Fig. 271. The tooth-tip flux within the limits of the pole is

$$\frac{\frac{4\pi}{10} z}{\frac{\delta'_i}{l'_i \left[\frac{b'_i}{2} + \left(x - \frac{r_1}{2} \right) \right]} + \frac{\delta'_i}{l'_i \left[\frac{b'_i}{2} - \left(x - \frac{r_1}{2} \right) \right]}} = \frac{4\pi}{10} z \frac{l'_i}{4\delta'_i} \left[\frac{(b'_i - r_1)^2 - 4x^2}{b'_i - r_1} \right]$$

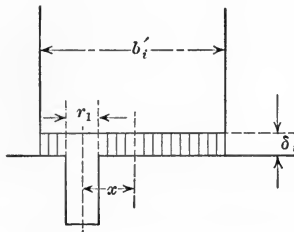

FIG. 271.—Tooth-tip flux under interpole.

and the average inductance, considering both sides of the coil, is

$$L_2 = 2 \times \frac{4\pi}{10^9} z^2 \frac{l'_i}{4\delta'_i} \int_0^{\frac{b'_i - b_0}{2}} \left\{ (b'_i - r_1) - \frac{4x^2}{b'_i - r_1} \right\} dx$$

$$= \frac{4\pi}{10^9} z^2 l'_i \frac{(b'_i - r_1)^2}{6\delta'_i}$$

In the above equations δ'_i is the corrected gap length, $\delta_i \frac{t}{t - \sigma r_1}$, all dimensions being expressed in centimeters.

If $l' < l'_i$, there must be added to the above expression a term

$$\frac{4\pi}{10^9} z^2 (l' - l'_i) \times 1.46 \log_{10} \left[1 + \frac{\pi(\tau - b)}{2r_1} \right]$$

169. Compounding Effect of Commutating Poles.—In Chap. V, it was shown that a forward lead of the brushes in the case of a generator produces a demagnetizing effect and consequently reduces the generated e.m.f., while a backward lead causes a com-

pounding action. If the generator is provided with commutating poles, these effects of brush displacement are accentuated, as may be seen from Fig. 272. Thus, Fig. 272*a* represents the conditions when the brushes are in the geometrical neutral axis; the armature winding between adjacent brushes of opposite polarity is then acted upon by the flux due to a main pole only,

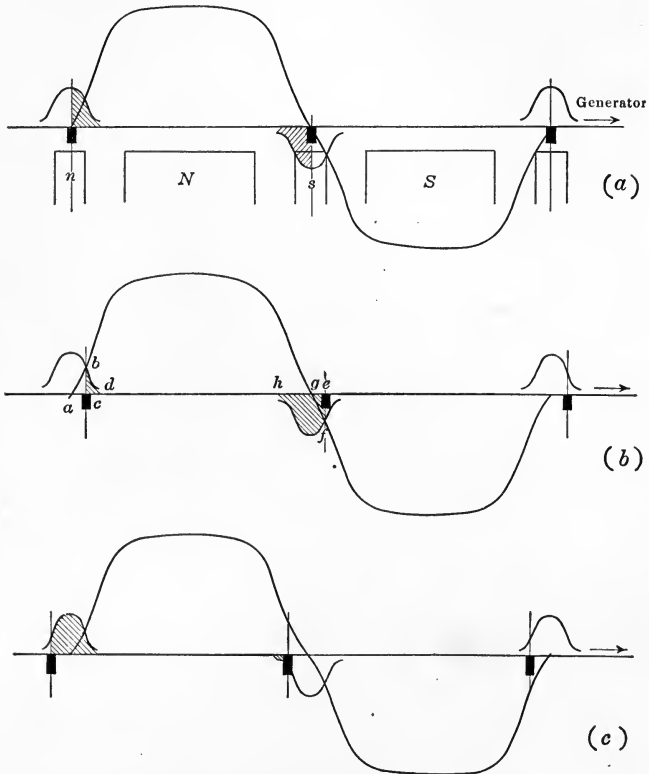

FIG. 272.—Compounding effect of interpoles.

the effect of the oppositely directed fluxes due to the interpoles (shown by the hatched areas) being to annul each other. If the brushes are displaced in the direction of rotation, Fig. 272*b*, the total flux is reduced by the difference between the hatched areas efh and bcd and in addition by the sum of areas abc and efg . In the same manner a backward displacement of the

brushes, Fig. 272c, results in an increase of the flux linked with the armature winding.

Similar considerations show that in the case of commutating pole motors a forward lead of the brushes will increase the flux and therefore reduce the speed, while a backward lead will decrease the flux and raise the speed. In Chap. VII it was shown that a considerable backward displacement of the brushes of a commutating pole motor may result in a continuous succession of reversals of rotation. If actual reversal of direction does not occur, pulsation of speed may result, for since the effect of a backward displacement is to weaken the active field, there will be a corresponding decrease of counter e.m.f. and an increase of armature current to produce the necessary acceleration of the armature. The increased current further strengthens the interpoles, and so still further weakens the field and accelerates the armature. But the counter e.m.f. is proportional to the active flux and to the speed. The tendency to accelerate the armature will then continue until the decrease of counter e.m.f. due to reduced flux is offset by the increase due to greater speed. The decrease of field strength cannot, however, go on indefinitely, because the interpoles eventually become saturated, but up to the time that saturation of the interpoles sets in, the speed has been continuously increasing, and the momentum of the armature will cause the speed to continue to increase even after the flux has reached a practically constant value; especially will this be true if the rotating parts have large moment of inertia. The result will be a rapid increase of counter e.m.f., possibly to a value greater than the line voltage, in which case the machine would become a generator drawing upon its kinetic energy of rotation to send current back to the supply line. The speed under these conditions would rapidly fall, causing such a reduction of counter e.m.f. that the armature current again rises, thereby producing increased speed, and so repeating the above-described cycle of changes.

CHAPTER X

EFFICIENCY, RATING AND HEATING

170. Sources of Loss.—In every dynamo-electric machine the net power output is less than the gross power input, the difference being consumed in the internal losses of the machine. The losses may be grouped under the following heads:

1. THE OHMIC LOSSES, due to the heating effect of the current flowing through the resistances of

- (a) the armature winding,
- (b) the field winding,
- (c) the brushes and brush contacts.

2. THE IRON OR CORE LOSSES, due to

- (a) hysteresis in the armature core and teeth,
- (b) eddy currents in the armature core, teeth, and pole faces.

3. THE MECHANICAL LOSSES, due to

- (a) bearing friction,
- (b) friction between the moving parts and air, or "windage,"
- (c) brush friction.

4. ADDITIONAL MISCELLANEOUS LOSSES caused by

- (a) eddy currents in the armature conductors,
- (b) the short-circuit currents in the commutated coils,
- (c) pulsations of the flux set up by the current in the short-circuited coils,
- (d) eddy currents in the end plates of the armature, in non-insulated bolts through laminated core, etc.

171. The Ohmic Losses.—The power consumed when a current of i amperes flows through a resistance of r ohms is i^2r watts.

The combined ohmic or i^2r losses in the armature and field windings are commonly referred to as the "copper losses."

(a) *The armature copper loss* in all types of generators and motors is

$$P_{ca} = i_a^2 r_a \text{ watts} \quad (1)$$

where the armature resistance is to be computed or measured at the normal working temperature. In general,

$$r_a = \rho_0 \frac{l_a}{s_a} (1 + 0.0042t) \frac{1}{\alpha^2} \text{ ohms} \quad (2)$$

where ρ_0 = specific resistance of the armature copper at 0°C .

l_a = total length of wire on the armature

s_a = cross-section of the armature conductors

t = working temperature of the armature in degrees Centigrade

α = number of armature circuits in parallel.

If the length is expressed in feet and the cross-section in circular mils, $\rho_0 = 9.59$ ohms; if these dimensions are expressed in centimeters and square millimeters, respectively, $\rho_0 = 0.016$ ohm.

(b) *The field copper loss* in separately excited machines is

$$P_{cf} = i_f^2 r_f \text{ watts} \quad (3)$$

and in plain series generators and motors is

$$P_{cf} = i_a^2 r_f \text{ watts} \quad (4)$$

where r_f represents the combined resistance of the field winding and its regulating shunt if the latter is used.

In shunt machines the field loss is

$$P_{cf} = i_s^2 r_s = \frac{E_t^2}{r_s} = E_t i_s \text{ watts} \quad (5)$$

where r_s includes the resistance of the regulating rheostat if one is used.

In long-shunt compound machines, the field loss (total) is

$$P_{cf} = i_a^2 r_f + i_s^2 r_s \text{ watts} \quad (6)$$

where $i_a = i + i_s$ in case the machine is a generator, and $i_a = i - i_s$ in case it is a motor.

In short-shunt compound machines the total field loss is

$$P_{cf} = i^2 r_f + i_s^2 r_s \text{ watts} \quad (7)$$

the above relations again holding between i , i_a and i_s .

(c) The ohmic loss at the commutator depends upon the drop of potential at the transition surface between commutator and brushes, as well as upon the amount of current flowing. If the drop of potential at each brush is Δe , the loss is

$$P_{cc} = 2i_a \Delta e \text{ watts} \quad (8)$$

With the usual type of carbon brushes, Δe is approximately 1 volt when the brush current density has values common in ordinary practice (see Fig. 261). Values of Δe as determined by Arnold are as follows:¹

Very soft carbon brushes,	0.4 to 0.6 volts
Soft carbon brushes,	0.55 to 0.7 volts
Medium carbon brushes,	0.9 to 1.1 volts
Very hard carbon brushes,	1.2 to 1.5 volts
Copper brushes (65 to 160 amperes per sq. in.)	0.017 to 0.03 volts.

It is common, however, to include the ohmic loss at the commutator in that of the armature winding, r_a being increased sufficiently to include the average brush contact resistance. This method may lead to inaccuracy, especially at light loads.

172. The Core Losses.—

(a) Hysteresis Loss.—

In the Armature Core.—The relative motion between the armature core and the magnetic field of force produces a periodic reversal of the magnetism of the core, thereby giving rise to a loss of power through molecular friction in the mass of the armature core. This *hysteresis* loss can be represented by an empirical equation due to Steinmetz

$$P_{ha} = \eta f V B_a^{1.6} \text{ watts} \quad (9)$$

where

¹Die Gleichstrommaschine, Vol. I, p. 351, 2nd. ed., 1906.

η = a constant depending upon the material of the core

$f = \frac{pn}{120}$ = the number of magnetic cycles per second

V = the volume of the core

B_a = the maximum value of the flux density in the core.

If metric units are used in the above equation (volume in cubic centimeters and flux density in lines per sq. cm.), $\eta = 0.0021 \times 10^{-7}$ for ordinary sheet steel; if volume is expressed in cubic inches and flux density in lines per sq. in., $\eta = 0.0017 \times 10^{-7}$. Since the weight, W , of the core is pro-

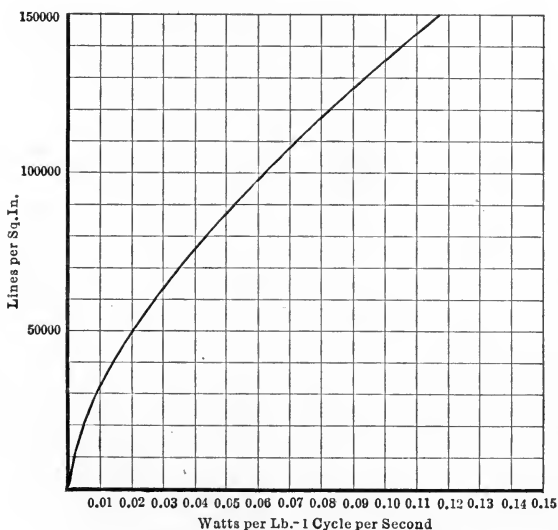

FIG. 273.—Curve of hysteresis loss.

portional to its volume, the equation for the hysteresis loss can also be written

$$P_{ha} = \eta f W B_a^{1.6} \text{ watts} \quad (10)$$

in which case $\eta = 0.0062 \times 10^{-7}$ if British units are used (weight in pounds, flux density in lines per sq. in.).

The curve of Fig. 273 shows the variation of the hysteresis loss, expressed in watts per pound per cycle per second, as a function of the flux density expressed in lines per sq. in., using the above value of η .

In the Armature Teeth.—The flux density varies from section to section because of the taper of the teeth, and it is not correct to compute the hysteresis loss by substituting an average value of flux density in the above equation.

Consider an element dx , Fig. 274, at a distance x below the tip of the tooth; its volume is

$$dV = blkdx = \left(b_t - \frac{b_t - b'_t}{l_t} x \right) lkdx$$

where k is the lamination factor (from 0.85 to 0.90). Assuming that the total flux is the same at all sections of the tooth, the flux density will vary inversely as the width of the section, or

$$B = \frac{b_t}{b} B_t$$

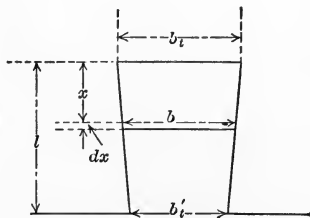

FIG. 274.—Computation of hysteresis loss in teeth.

where B_t is the actual, or corrected, flux density at the top of the tooth. The hysteresis loss in the element is then

$$dP_{ht} = \eta f B^{1.6} dV = \eta f k l b_t^{1.6} B_t^{1.6} \frac{dx}{b^{0.6}}$$

and the total loss per tooth is

$$\begin{aligned} P_{ht} &= \eta k f l b_t^{1.6} B_t^{1.6} \int_0^{l_t} \frac{dx}{\left(b_t - \frac{b_t - b'_t}{l_t} x \right)^{0.6}} \\ &= 2.5 \eta k f l b_t^{1.6} B_t^{1.6} (b_t^{0.4} - b'^{0.4}) \frac{l_t}{b_t - b'_t} \end{aligned} \quad (11)$$

Since the volume of a tooth is

$$V_t = \frac{b_t + b'_t}{2} k l_t l$$

the above expression can be written

$$P_{ht} = \eta f V_t B_t^{1.6} \times 5 \frac{1 - \left(\frac{b'_t}{b_t}\right)^{0.4}}{1 - \left(\frac{b'_t}{b_t}\right)^2} \quad (12)$$

In other words, the expression for the hysteresis loss in the teeth is similar to the general expression, but with the addition of the factor

$$5 \frac{1 - \left(\frac{b'_t}{b_t}\right)^{0.4}}{1 - \left(\frac{b'_t}{b_t}\right)^2}$$

The ordinates of Fig. 275 give the value of this factor for various values of b'_t/b_t .

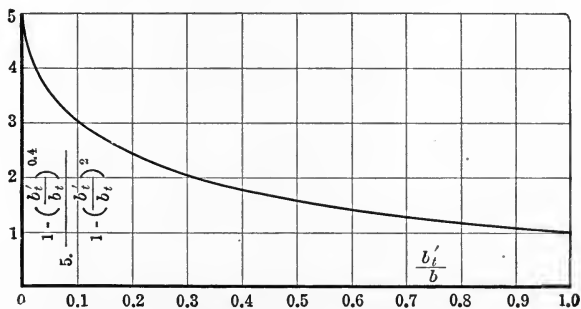

FIG. 275.—Correction factor, hysteresis loss in teeth.

(b) **Eddy Current Losses.**—That part of the core loss due to eddy or Foucault currents can be approximately calculated by the formula derived below, but it is more usual to determine the loss under known experimental conditions for reasons that will appear later.

Consider a radial element, Q , Fig. 276, of one of the armature core stampings. Let the thickness of the stamping be t , and let ct be the radial depth of the core, where c is a numeric. When the element is in the vertical position OA , the flux passing through its lateral walls is a maximum, and when it is in the horizontal axis OB the flux is zero. This change of flux occurs four times per revolution in a bipolar machine, or, in general, four times per magnetic cycle. The changing flux induces an alternating e.m.f.

and sets up a corresponding alternating current which may be assumed to flow in paths like those indicated in the lower part of the figure; an elementary current path is then bounded by similar rectangles of widths $2x$ and $2(x + dx)$, and lengths $2cx$ and $2c(x + dx)$, respectively. The change of flux through such an elementary circuit will be $4B_a \times 4cx^2$ lines per magnetic cycle, where B_a is the maximum flux density in the core, or $16B_a cx^2 f$ lines per second, where f is the number of magnetic cycles per second. The average e.m.f. in the elementary circuit will be $16B_a cf x^2 \times 10^{-8}$ volts. The resistance of the path is

$$\gamma \left[\frac{4cx}{h dx} + \frac{4x}{h c dx} \right]$$

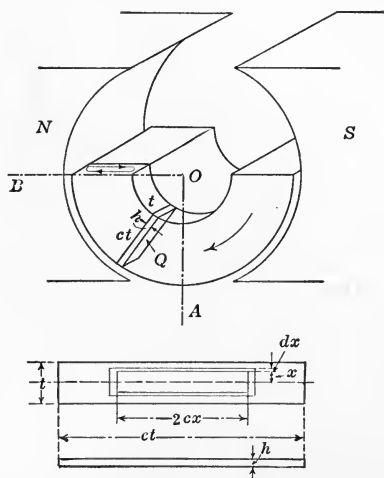

FIG. 276.—Elementary paths of eddy currents.

where γ is the specific resistance of the material of the core. The loss in the elementary path is

$$i^2 r = \frac{e^2}{r} = \frac{(16B_a cf x^2 \cdot 10^{-8})^2}{\frac{4\gamma x}{h dx} \left(c + \frac{1}{c} \right)} = \frac{64h B_a^2 f^2 x^3 dx}{\gamma} \cdot \frac{c^3}{c^2 + 1} \cdot 10^{-16}$$

and the total loss is

$$P_{ea} = \frac{64h B_a^2 f^2}{\gamma \times 10^{16}} \frac{c^3}{c^2 + 1} \int_0^{t/2} x^3 dx = \frac{h B_a^2 f^2 t^4}{\gamma \times 10^{16}} \frac{c^3}{c^2 + 1}$$

But hct^2 is the volume of the element, hence the loss is

$$P_{ea} = \frac{B_a^2 f^2 t^2}{\gamma \times 10^{16}} \cdot \frac{c^2}{c^2 + 1} \quad (\text{volume of tooth}) \text{ watts} \quad (13)$$

This equation shows that the eddy current loss varies as the square of the flux density, the square of the frequency of the magnetic reversals, and the square of the thickness of the laminations; and inversely as the specific resistance of the core material. The equation cannot, however, be relied upon for accurate results, because the actual distribution of the current may differ considerably from the assumed distribution, and the laminations

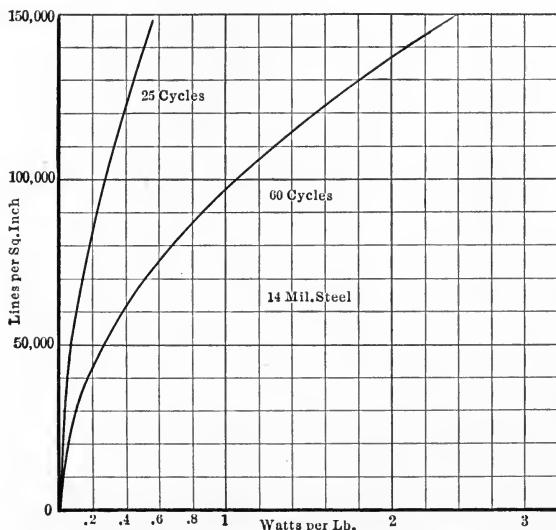

FIG. 277.—Curves of eddy current loss.

are not perfectly insulated from each other, as has been tacitly assumed. Due to these causes the actual measured loss will be from 50 to 100 per cent. greater than that computed from the formula. Thus, assuming

$$B_a = 10,000 \text{ gausses}$$

$$f = 60 \text{ cycles}$$

$$t = 14 \text{ mils} = 0.0356 \text{ cm.}$$

$$r = 12 \times 10^{-6} \text{ ohms per cm. cube}$$

$$\frac{c^2}{c^2 + 1} = 1 \text{ (nearly)}$$

the loss in watts per pound by the above formula is 0.22, while the observed value for these data in the case of annealed sheet steel is 0.44 watts per pound. Fig. 277 shows the variation of eddy current loss with flux density at frequencies of 25 and 60 cycles per second and for laminations 14 mils thick. The loss at other frequencies and thicknesses can then be computed by observing that the loss varies as the squares of these quantities.

Eddy Current Loss in the Teeth.—Referring to Fig. 274, the eddy current loss in an elementary section of a tooth is

$$\begin{aligned} dP_{et} &= \epsilon f^2 t^2 B^2 \times \text{volume} = \epsilon f^2 t^2 B^2 b k l dx \\ &= \epsilon f^2 t^2 b_t^2 B_t^2 k l \frac{dx}{b} \end{aligned}$$

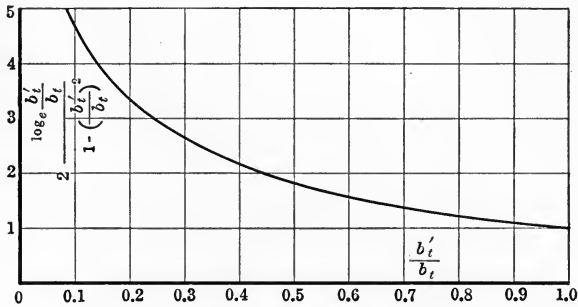

FIG. 278.—Correction factor, eddy current loss in teeth.

where ϵ is the eddy current constant. Integrating,

$$\begin{aligned} P_{et} &= \epsilon f^2 t^2 b_t^2 B_t^2 k l \int_0^{l_t} \frac{dx}{b_t - \frac{b'_t}{l_t} x} \\ &= \epsilon f^2 t^2 b_t^2 B_t^2 k l \frac{l_t}{b_t - b'_t} \log_e \frac{b_t}{b'_t} \\ &= \epsilon f^2 t^2 B_t^2 \times \text{volume of tooth} \times 2 \frac{\log_e \frac{b_t}{b'_t}}{1 - (b'_t/b_t)^2} \end{aligned} \tag{14}$$

This equation differs from the original equation, (13), in that it contains the additional factor

$$2 \frac{\log_e b_t/b'_t}{1 - (b'_t/b_t)^2}$$

the value of which is shown as a function of b'_t/b_t in Fig. 278.

Eddy Current Loss in the Pole Faces.—Reference has been made in Chap. II to the cause of the eddy current loss in the pole faces. This loss is confined to a relatively thin layer at the face of the pole because the direction of the induced eddy currents is always such as to damp out the flux pulsations that produce them (Lenz's law).

The flux pulsation at any given point in the pole face will pass through a complete cycle of changes in the time required for a point on the armature to move over a distance equal to the tooth pitch, that is, in a time $t' = \frac{t}{\pi dn/60}$ seconds. This gives a frequency of $f_t = \frac{1}{t'} = \frac{\pi dn}{60t} = \text{number of teeth} \times \text{rev. per sec.}$

Fig. 279 represents the variation of flux density at the pole face on the assumption that the curve of distribution is sinus-

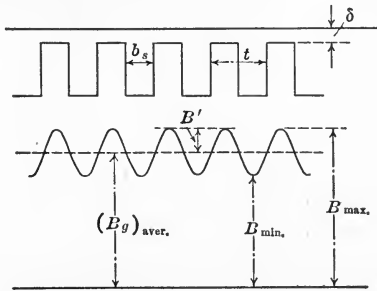

FIG. 279.—Variation of flux density opposite teeth and slots.

oidal. The amplitude of the pulsation is $B' = \frac{B_{max} - B_{min}}{2}$.

Then if

v = peripheral velocity of the armature in centimeters per second

μ = permeability of the material of pole face

ρ = specific resistance of material of pole face in absolute electromagnetic units

the pole face loss in watts per sq. cm. is¹

$$P_p = \frac{B_1^2}{8\pi} \sqrt{\frac{v^3 t}{\mu \rho}} \times 10^{-7} = k^2 \frac{B_g^2}{8\pi} \sqrt{\frac{v^3 t}{\mu \rho}} \times 10^{-7} \quad (15)$$

¹ Potier, *L'Industrie Electrique*, 1905, p. 35.

Rüdenberg, *Elektrotechnische Zeitschrift*, Vol. XXVI, p. 181, 1905.

where $k^2 = \left(\frac{B'}{B_g}\right)^2$ is a function of the relative dimensions of the air-gap, teeth and slots. Adams¹ has worked out the curve of Fig. 280 as giving fairly satisfactory values of k^2 in terms of the ratio b_s/δ . If British units are used (B_g in lines per sq. in., v in feet per second, t in inches, and μ and ρ as above) the loss in watts per sq. in. of pole face is given as

$$P_p = 1.65 \times 10^{-7} k^2 B_g^2 \sqrt{\frac{v^3 t}{\mu \rho}} \quad (16)$$

Total Core Loss.—Except in the case of special designs, it is more convenient to have access to the combined values of hysteresis and eddy current losses than to compute each of these losses separately. Test methods lend themselves readily to the determination of the total core loss, and from the results of such tests curves like Fig. 281² can be prepared.

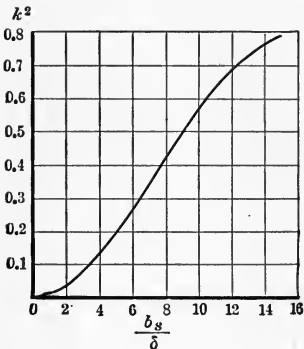

FIG. 280.—Constant for calculation of pole-face loss.

173. Mechanical Losses.—

(a) and (b). **Bearing Friction and Windage.**—While it is possible to compute the loss due to bearing friction, the loss due to windage involves so many complex variables that calculation of its magnitude is impossi-

ble. As it is likewise impossible to separate the combined value of the two losses as obtained by test measurements, they are always grouped as *friction and windage* loss. This loss varies from 1 to 3 per cent. of the rated capacity in high-speed machines of moderate capacity, and from 0.8 to 2 per cent. in low-speed machines of moderate size. In large direct-connected machines the loss will be from $\frac{1}{2}$ to 1 per cent. In very high-speed machines, such as turbo-generators, the loss due to windage will be increased.

Friction loss in the bearings varies with the $\frac{3}{2}$ power of

¹ Adams, Lanier, Pope and Schooley, Trans. A.I.E.E., Vol. XXVIII, p. 1133, 1909.

² From Gray's Electrical Machine Design, p. 102.

the peripheral velocity of the shaft in the bearings, up to velocities of about 1800 ft. per minute; at higher velocities it varies directly with the velocity. The windage loss, as in the case of fans, varies as the third power of the speed. But in both cases these losses are independent of the load on the machine.

(c) **Commutator Friction Loss.**—

Let

d_{com} = diameter of the commutator, inches

A_b = total area of brush contact, sq. in.

p_c = brush pressure (lb. per sq. in.)

f = coefficient of friction.

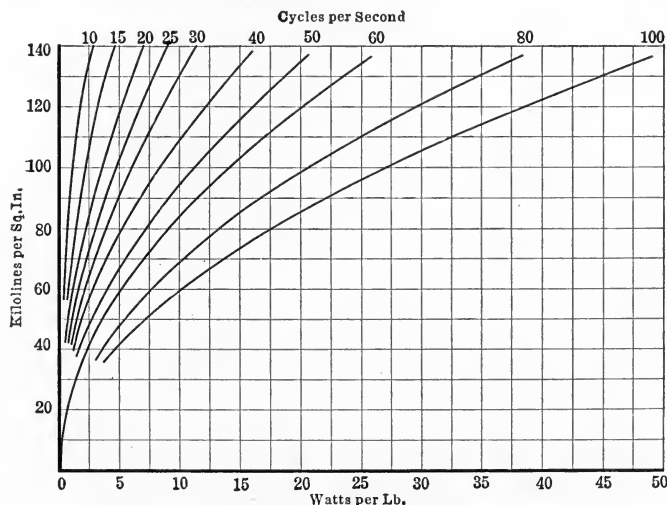

FIG. 281.—Total core loss.

Then the brush friction loss, in watts, is

$$P_{bf} = \frac{\pi d_{com} n}{12} \cdot \frac{A_b p_c f}{33,000} \times 746 = 0.0059 d_{com} n A_b p_c f \text{ watts} \quad (17)$$

Ordinarily the value of p_c is from 1.5 to 2 lb. per sq. in., and f is about 0.3 for carbon brushes and 0.2 for metal brushes.

174. Additional Losses.—

(a) **Eddy Currents in the Armature Conductors.**—When large, solid armature conductors are used in open slots, different portions of the same section of the conductor may be simultaneously in fields of different strength. Under these conditions e.m.fs. of

different magnitudes will be generated from point to point of the cross-section, and eddy currents will result. The loss due to these eddy currents may be from 5 to 15 per cent. of the loss due to the ohmic resistance. This is equivalent to saying that, so far as the armature copper loss is concerned, the effective armature resistance is from 5 to 15 per cent. greater than the true resistance. This loss may be minimized by stranding the conductors or using smaller conductors in parallel.

(b), (c) and (d) **Miscellaneous Losses Due to Short-circuited Currents, Etc.**—These are minor losses, and cannot be computed. In testing, they are absorbed in the amount attributed to friction, windage, and core losses.

175. Summary of Losses.—

COPPER LOSS:

Armature.....	$i_a^2 r_a$
Field: separately excited.....	$i_f^2 r_f$
series.....	$i_a^2 r_f$
shunt.....	$i_s^2 r_s$
compound, long shunt.....	$i_a^2 r_f + i_s^2 r_s$
compound, short shunt.....	$i^2 r_f + i_s^2 r_s$
Commutator.....	$2i_a \cdot \Delta e$

CORE LOSS:

Hysteresis: armature core.....	$\eta f V B_a^{1.6}$
armature teeth.....	$\eta f V_t B_t^{1.6} \times 5 \frac{1 - \left(\frac{b'_t}{b_t}\right)^{0.4}}{1 - \left(\frac{b'_t}{b_t}\right)^2}$
Eddy currents: armature core.....	$\epsilon f^2 t^2 B_a^2 V$
armature teeth.....	$\epsilon f^2 t^2 B_t^2 V_t \times 2 \frac{\log_e b_t/b'_t}{1 - (b'_t/b_t)^2}$
pole faces.....	$k^2 B_p^2 \sqrt{\frac{v^3 t}{\mu \rho}} \times \text{constant}$

MECHANICAL LOSSES:

Bearing friction and windage.....	$\frac{1}{2}$ to 3 per cent. depending upon size and speed.
Brush friction.....	$0.0059 d_{com} n A_b p_e f$

MISCELLANEOUS LOSSES:

Eddy currents in armature conductors.....	(0.05 to 0.15) $i_a^2 r_a$
Losses due to currents in short-circuited coils, etc.	

176. True Efficiency, Efficiency of Conversion, Electrical and Mechanical Efficiency.—The true or *commercial efficiency* of a machine, generally referred to simply as the efficiency, is the ratio of the net power output to the gross power input, both quantities being expressed in terms of the same unit. In the case of a generator the output is electrical and the input mechanical; in motors, the output is mechanical and the input electrical. In either case,

$$\text{efficiency} = \frac{\text{output}}{\text{input}} = \frac{\text{output}}{\text{output} + \text{losses}} = \frac{\text{input} - \text{losses}}{\text{input}} \quad (18)$$

If E_t and i are the terminal voltage and the line current, respectively, the expression for the efficiency of a generator becomes

$$\eta = \frac{E_t i}{E_t i + P} \quad (19)$$

where P is the summation of all the losses.

That of a motor becomes

$$\eta = \frac{E_t i - P}{E_t i} \quad (20)$$

For the sake of convenience, the total losses may be divided into two groups, (1) the pure *ohmic or copper losses*, due to the flow of current through the resistance of the armature and field windings, and (2) the *stray power loss*, which include all the remaining losses. Then

$$\text{input} = \text{output} + \text{ohmic losses} + \text{stray power loss} \quad (21)$$

In the case of *generators*, the expression

$$\text{input} - \text{stray power loss} = \text{output} + \text{ohmic losses} \quad (22)$$

represents the total electrical power actually developed in the armature, and the ratio of this total electrical power to the total mechanical power input is defined as the *efficiency of conversion*; that is,

$$\eta_c = \text{efficiency of conversion} = \frac{\text{electrical power developed}}{\text{mechanical power input}} = \frac{\text{input} - \text{stray power losses}}{\text{input}} = \frac{\text{output} + \text{copper losses}}{\text{input}} \quad (23)$$

The ratio of the net electrical output to the total electrical power

developed in the armature is called the *electrical efficiency*, or

$$\eta_e = \text{electrical efficiency} = \frac{\text{electrical output}}{\text{electrical power developed}} = \frac{\text{output}}{\text{output} + \text{copper losses}} \quad (24)$$

Evidently,

$$\eta = \eta_c \eta_e \quad (25)$$

In the case of *motors*, on the other hand, the expression

$$\text{input} - \text{copper losses} = \text{output} + \text{stray power loss} \quad (26)$$

represents the total mechanical power developed by the machine, and the ratio of this power to the input is again the efficiency of conversion; that is,

$$\eta_c = \frac{\text{input} - \text{copper losses}}{\text{input}} = \frac{\text{output} + \text{stray power loss}}{\text{input}} \quad (27)$$

The *mechanical efficiency* is the ratio of the net mechanical output to the mechanical power developed, or

$$\eta_m = \text{mechanical efficiency} = \frac{\text{output}}{\text{output} + \text{stray power loss}} = \frac{\text{output}}{\text{input} - \text{copper losses}} \quad (28)$$

It follows that

$$\eta = \eta_c \eta_m \quad (29)$$

177. The Stray Power Loss.—The stray power loss includes all the losses except those due to the pure ohmic resistance of the various windings, and is, therefore, made up of the core loss, friction and windage, brush contact loss and the miscellaneous load losses. In the case of machines which operate at approximately constant speed and constant flux, as, for example, generators and motors of the separately excited and shunt types, the stray power loss remains nearly constant at all loads within the working range. The distortion of the flux due to armature reaction tends to increase the core loss, but this tendency is more or less compensated, except in compound generators, by the decrease of the flux as a whole. The stray power loss of a shunt machine can be determined in a simple manner by running it as a motor without load at its rated voltage

and normal excitation and measuring the current input to its armature (i_a)₀. The product of impressed voltage and armature current is then equal to the stray power loss plus the ohmic loss in the armature; or

$$P_s = E_t(i_a)_0 - (i_a)_0^2 r_a \quad (30)$$

This test should be made immediately after the machine has been running under load in order that the armature shall have reached its working temperature.

In machines in which the speed or the flux, or both of them, are inherently variable under operating conditions, as for example in series motors, the stray power loss is also variable. The stray power loss of a series motor is found experimentally by running the machine separately excited and without load. Adjust the field current to about its full-load value and start the motor by gradually increasing the voltage impressed upon the armature. After the motor starts, increase the excitation until the field current has the highest value it will have under load conditions, and adjust the armature voltage to a value at which a reading is desired. Note the field current, armature current and voltage, and the speed. Keeping the excitation constant, adjust the armature voltage to two or three different values, and for each setting take readings as before. The armature voltages ordinarily used in this test are 250, 400 and 550 volts for 550-volt motors, and 300, 450 and 650 volts for 650-volt motors. Repeat this series of readings for a number of other values of field current, down to the lowest field current consistent with safe speed. The stray power can then be computed by deducting the ohmic loss in the armature from the armature input.

If it is desired to separate the stray power loss thus determined into friction and windage and core losses, the machine should be run as a series motor without load and at reduced voltage. By varying the impressed voltage through a sufficient range to cover the working range of speed, and taking simultaneous readings of impressed voltage, current and speed, the friction and windage corresponding to any speed may be taken as equal to the power supplied, less the ohmic losses in the armature and field windings, the core loss being negligible under these test conditions. The core loss at any given speed is then equal to the difference be-

tween the total stray power loss and the friction and windage loss at the same speed. In this manner curves like Figs. 282 and 283

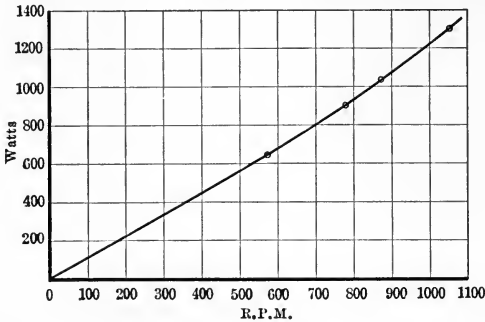

FIG. 282.—Friction and windage as a function of speed. Railway motor test.

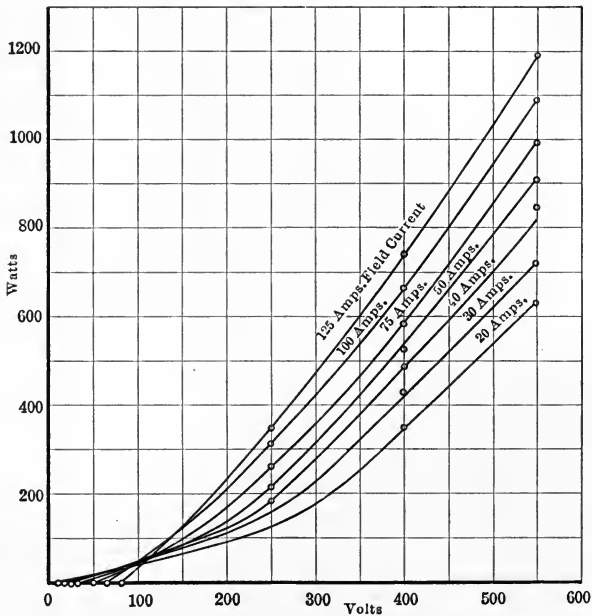

FIG. 283.—Core loss of series motor.

may be determined;¹ data taken from these curves can then be used to calculate the efficiency at any load.

¹ Motor and Generator Testing, Westinghouse Elec. and Mfg. Co.; Sec. 8, pp. 8 and 11. July, 1913.

178. Variation of Efficiency with Load. Condition for Maximum Efficiency.—Let it be assumed that a certain 250-kw., 550-volt, flat-compounded long-shunt generator has the following losses:

COPPER LOSS:

Armature and series field at full load.....	5500 watts.
Shunt field loss, including rheostat.....	1250 watts.

STRAY POWER LOSS:

Core loss.....	3500 watts.
Friction and windage.....	2000 watts.
Commutator loss, average.....	1000 watts.

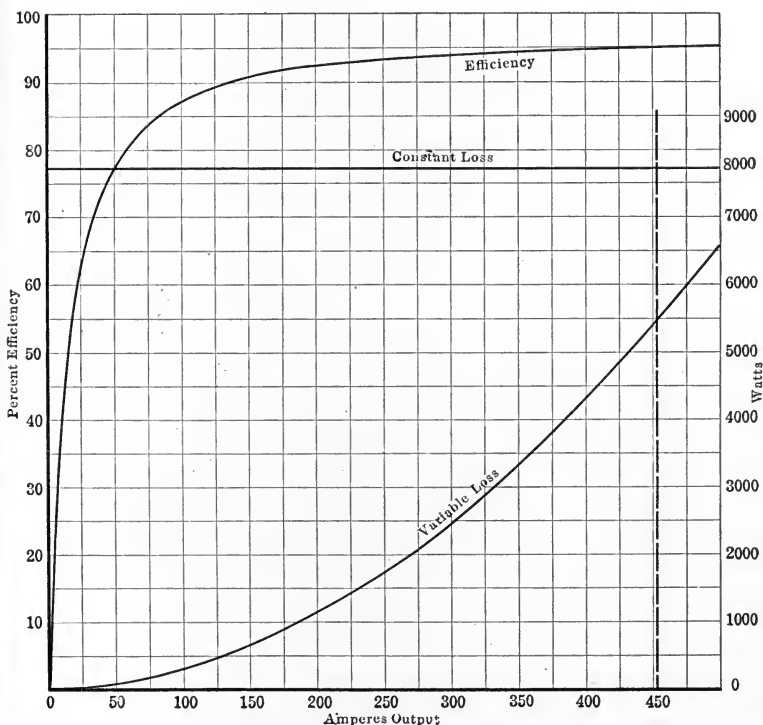

FIG. 284.—Losses and efficiency.

Assuming that all these losses, except those in the armature and series field, remain constant, there will be a constant loss of 7750 watts at all loads and a variable loss increasing according to a parabolic law from zero at no-load to 5500 watts at full-load.

These losses and the variation of the efficiency are shown graphically in Fig. 284; the efficiency is computed from the equation

$$\eta = \frac{550i}{550i + 7750 + (r_a + r_f)i_a^2}$$

where

$$i_a = i + i_s = i + \frac{1250}{550} = i + 2.27$$

$$r_a + r_f = \frac{5500}{\left(\frac{250,000}{550} + 2.27\right)^2} = 0.0263$$

The above example is typical of those cases in which the losses consist of a constant term and a term that varies as the square of the load. In such cases *the efficiency has its maximum value when the variable loss equals the constant loss.* Writing

$$\eta = \frac{E_t i}{E_t i + P_{const} + (r_a + r_f)i_a^2} = \frac{E_t}{E_t + \frac{P_{const}}{i} + (r_a + r_f)i} \quad (31)$$

it is clear that η will have its maximum value when the denominator of the fraction is a minimum, E_t being assumed constant. Differentiating the denominator with respect to i and equating to zero,

$$-\frac{P_{const}}{i^2} + (r_a + r_f) = 0$$

or

$$i^2(r_a + r_f) = P_{const} = i_a^2(r_a + r_f) \quad (32)$$

which agrees with the statement above. A second differentiation will verify the statement that the condition thus determined is for minimum value of the denominator of the fraction.

When it is necessary to use greater refinement than in the preceding example, the following corrections may be applied:

1. The core loss (due to hysteresis and eddy currents) may be taken to increase linearly with the load current because of the compounding effect, or

$$P_{h+e} = (P_{h+e})_0 + ci \quad (33)$$

where $(P_{h+e})_0$ is the core loss at no-load and c is a constant.

2. The bearing friction, windage and commutator friction will remain constant as before.

3. The total brush contact drop may be taken¹ as

$$2\Delta e = \frac{i_a}{20 \times \text{total brush area in sq. in.}} + 1 \quad (34)$$

so that the loss due to brush contact drop is

$$P_b = i_a \left(\frac{i_a}{20 \times \text{total brush area}} + 1 \right) \quad (35)$$

4. The armature loss is $i_a^2 r_a$ as before.

5. The shunt field loss is $\frac{E_t^2}{r_s}$ in plain shunt and in long-shunt compound machines, and

$$\frac{(E_t \pm i r_f)^2}{r_s}$$

in short-shunt machines, the positive sign being used in case of generators, the negative sign in the case of motors.

6. The series field loss is $i_a^2 r_f$ in long-shunt machines, and $i^2 r_f$ in short-shunt machines.

The summation of all the losses therefore includes a constant term, a term that varies directly with the line current, and a term that varies as the square of the current; hence the efficiency is given by an expression of the form

$$\begin{aligned} \eta &= \frac{E_t i}{E_t i + P_{const} + C_1 i + C_2 i^2} \\ &= \frac{E_t}{E_t + \frac{P_{const}}{i} + C_1 + C_2 i} \end{aligned} \quad (36)$$

Differentiating the denominator and equating to zero, the condition for maximum efficiency is found to be

$$-\frac{P_{const}}{i^2} + C_2 = 0$$

or

$$P_{const} = C_2 i^2 \quad (37)$$

In this expression P_{const} is evidently equal to the total loss at no-load ($i = 0$), and $C_2 i^2$, or that part of the load loss which varies as the square of the current, is nearly equal to $i_a^2 (r_a + r_f)$.

¹ Motor and Generator Testing, Westinghouse Electric and Manufacturing Co.

Hence, for maximum efficiency, the loss in the armature and series field should equal the loss at no-load.

179. Location of Point of Maximum Efficiency.—From the preceding article it is clear that by a proper choice of the relation between the fixed and the variable losses the point of maximum efficiency may be made to fall at any desired output. For example, assume that the total losses consist of a constant term, P_{const} , and a term variable with the square of the load. Let the rated full-load output be P_0 , and let the constant loss be xP_0 , where x is any fractional part of the output, and let the variable loss at full load be yP_0 , where y is any fractional part of the output. Then the efficiency at full-load is

$$\eta = \frac{1}{1 + x + y} \quad (38)$$

Let zP_0 be the output at which it is required that the efficiency be a maximum. The variable loss will be $z^2(yP_0)$, and for maximum efficiency

$$z^2(yP_0) = xP_0$$

or

$$z = \sqrt{\frac{x}{y}} \quad (39)$$

For example, let it be required to divide the total losses in such a way that the maximum efficiency shall occur at three-fourths load and that the efficiency at rated full-load shall be 85 per cent. Then

$$\frac{1}{1 + x + y} = 0.85$$

$$z = \sqrt{\frac{x}{y}} = 0.75$$

from which $x = 6.35$ per cent. and $y = 11.3$ per cent.

It is seen that if the fixed losses, represented by x , are relatively large, and the variable copper losses, represented by y , are small, maximum efficiency will probably occur beyond full-load. To make the maximum efficiency occur at a fractional part of full-load, the copper losses should be large compared with the fixed losses. Thus, if it is known that a machine is to be operated for considerable periods at light loads and only

occasionally at full-load or overloads, it should be so designed as to have a relatively high armature resistance in order to make the efficiency a maximum at or near the point of average load.

180. All-day Efficiency.—*The all-day efficiency of a machine is the ratio of the net energy output to the total energy input during a working day. Inasmuch as charges for electrical service are based largely on energy consumption (kilowatt-*

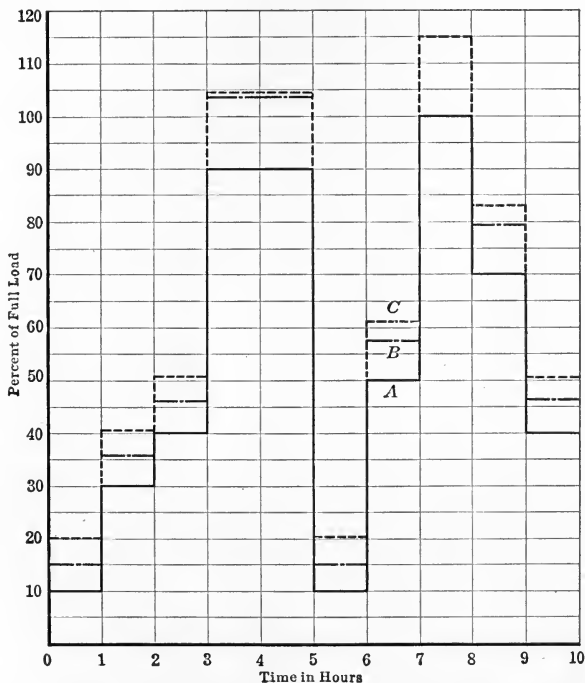

FIG. 285.—A, Load curve; B and C, curves of power input.

hours), it is important that the all-day efficiency of a motor that runs continuously should be as high as possible. The all-day efficiency of a machine is dependent to a large extent upon the shape of its *load curve A*, Fig. 285, and is also affected by the ratio of its fixed and variable losses. The ordinates of the load curve represent power output and the abscissas represent time, so that the area under the curve is proportional to the energy output. If this load is carried by a motor whose fixed losses are 5 per cent., and whose variable losses are 10 per cent.

of its rated output, the power input will vary as shown by curve *B*; while if the fixed and variable losses are, respectively, 10 and 5 per cent. of the rated output, the power input will be given by curve *C*. In the former case the all-day efficiency is 85.8 per cent., in the latter 81.7 per cent. The difference between the two becomes greater and greater, in favor of the machine with the lower fixed loss, as the period of light load increases; for example, if the machine runs for nine hours at 10 per cent. load, and one hour at full-load, the all-day efficiency of the first machine is 75.7 per cent. as against 64.3 per cent. for the second.

181. Rating and Capacity.—The rating or rated output of a machine is based on, but does not exceed, the maximum load which can be taken from it under prescribed conditions of test. If these prescribed conditions are those of the A.I.E.E. Standardization Rules, the rating is said to be the Institute rating; if the prescribed conditions are those of the International Electrical Commission, the rating is said to be the I.E.C. rating. The *capacity* of a machine, expressed in terms of its output, is the load or duty it will carry for a specified time, or continuously, without exceeding certain temperature limitations, as described in the next article.

The new (1914) Standardization Rules¹ of the A.I.E.E. define two kinds of ratings, namely, *continuous rating*, and *short-time rating*, the latter applying to machines designed for discontinuous or intermittent service. In determining the continuous rating, the machine is subjected to a *heat run*, or test under load conditions, for a sufficient length of time to bring about a constant difference of temperature, of prescribed amount, between the machine and the surrounding air. If the load on the machine is normal full-load, it may take from six to eighteen hours to reach stationary temperature conditions, but the time may be reduced by overloading the machine to a reasonable extent during the preliminary period. By taking temperature readings at more or less regular intervals during the test, and plotting rise of temperature against time, the shape of the curve so obtained will indicate to what extent the load should be increased or decreased. The *short-time* rating of machines intended to operate intermittently, that is, with more or less frequent stops of

¹ Proceedings A.I.E.E., August, 1914.

sufficient duration to allow cooling to occur, is the load that the machine will carry for a specified, limited period, without exceeding prescribed conditions of test.

Machines which operate on a cycle of duty that is repeated more or less regularly, as in elevator service, are rated in terms of an *equivalent load* which may be based either on a continuous or short-time test, but selected to simulate as closely as possible the thermal conditions of actual service. The standard durations of short-time equivalent tests are 5, 10, 30, 60 and 120 minutes.

The new Standardization Rules specify that the rated output of both generators and motors shall be expressed in kilowatts, thus marking a departure from the practice of rating motors in terms of horse-power. For practical purposes, the horse-power rating, if used, may be taken as four-thirds of the kilowatt rating.

182. Allowable Operating Temperatures.¹—Theoretically, the output of a generator is limited only by the possibility of sufficiently reducing the resistance of the receiver circuit, at the same time maintaining the generated e.m.f. and supplying the driving power; practically, however, the capacity of the machine is limited by the ability of the insulation to withstand without deterioration, and for long periods, the maximum temperature caused by the heating due to i^2r and other losses, though in some cases the load limit may be determined by commutating conditions. For each kind of insulating material there is a limiting temperature above which deterioration is very rapid, but so far as useful life of the insulation is concerned there seems to be no particular advantage in operating at temperatures below the safe limits. In case the machine is designed to operate at temperatures well within the safe limits, there will be a margin between its rating and its capacity, hence these terms are not synonymous. If the safe limits of temperature are exceeded, the deterioration of the insulation is rapid, the damage increasing with the duration and extent of the excess temperature.

In the Standardization Rules of the American Institute of Electrical Engineers in force prior to the adoption of the new

¹ The material in this article is taken from the Standardization Rules of the A.I.E.E. adopted by the Board of Directors, July 10, 1914, and effective December 1, 1914. See Proceedings A.I.E.E., August, 1914.

(1914) rules, it was specified that the allowable *rise* of temperature of the parts of a machine (excepting railway motors) should be as follows: armature and field windings, 50° C.; commutator, 55° C.; bearings, 40° C. These rises of temperature were based upon standard conditions of a room temperature of 25° C., a barometric pressure of 760 mm., and normal conditions of ventilation. It was further provided that if the room temperature differed from 25° C., the observed rise of temperature should be corrected by $\frac{1}{2}$ per cent. for each degree difference between room temperature and 25° C., the correction to be added to the observed rise if the room temperature was below 25° C., and subtracted if it was higher.

In the new rules (effective December 1, 1914), emphasis is placed upon the highest permissible temperature of the hottest spot as well as upon the maximum rise of temperature. The rise of temperature in the case of air-cooled machines (excluding railway motors) is based upon an ambient temperature of 40° C., but it is particularly specified that the observed rise of temperature must never exceed the limits given in the following table:

TABLE OF HOTTEST-SPOT TEMPERATURES AND OF CORRESPONDING PERMISSIBLE TEMPERATURE RISES

Class		Highest permissible temperatures for hottest spot	Highest permissible temperature rise of hottest spot above 40° for the purpose of fixing the Institute Rating
A1....	Cotton, silk, paper and other fibrous materials, not so treated as to increase the thermal limit.	95° C.	55° C.
A2....	Similar to A1, but treated or impregnated and including enameled wire.	105° C.	65° C.
B....	Mica, asbestos or other material capable of resisting high temperatures, in which any Class A material or binder, if used, is for structural purposes only, and may be destroyed without impairing the insulating or mechanical properties.	125° C.	85° C.

whatever may be the ambient temperature at the time of the test.

It will be noted that the above temperature limits recognize the advances in the art of constructing insulating materials that have been made since the adoption of the superseded rules. While it is known that insulating materials coming under the head of Class B can be supplied to withstand maximum temperatures of 150° C. and even higher, the limit has for the present been set at 125° C., pending the accumulation of more extensive data at higher temperatures; machines designed for maximum operating temperatures in excess of 125° C. must be subject to special guarantees by the manufacturer.

The temperature limits of commutators so constructed that no difficulties from expansion can occur are as follows:

Current per brush arm	Max. permissible temperature
200 amperes or less	130° C.
200 to 900 amperes	130° C. less 5° for each 100 amperes increase above 200.
900 amperes and over	95° C.

These temperatures hold for the metallic parts only. The temperature of insulation used in the commutator, or of any insulation whose temperature would be affected by the heat of the commutator, must in no case exceed the limits prescribed in the table of hottest-spot temperatures.

The new rules abolish the requirement of a correction of the observed rise of temperature due to a difference between the ambient temperature at the time of the test and the standard reference temperature (except in the case of air-blast transformers which are not considered in this text). This is due to the fact that numerous tests have shown that the effect of variations of the ambient temperature is small, obscure and of doubtful direction. It is, however, recommended that tests be conducted at ambient temperatures not lower than 25° C. The effect of high altitude in increasing the temperature rise of some types of machinery is recognized by specifying a reduction of the normal permissible temperature rise to the extent of 1 per cent. for each 100 meters by which the altitude exceeds 1000 meters.¹ In the case of machines intended for operation at an altitude of

¹ Water-cooled oil transformers are exempt from this reduction.

1000 meters or less, a test at any altitude less than 1000 meters is satisfactory and no temperature correction is necessary.

Three methods of determining temperatures of the various parts of a machine are specified, one or the other of these methods being adequate for commercial tests.

1. **THERMOMETER METHOD**, including measurements by mercury or alcohol thermometers, by resistance thermometers, or by thermo-couples, any of these instruments being applied to the hottest *accessible* part of the completed machine. When this method is used, the hottest-spot temperature is estimated by adding a hottest-spot correction of 15° C. to the highest temperature observed, except that when the thermometer is applied directly to the surface of a bare winding, such as an edgewise strip conductor or copper casting, the correction is 5° C. instead of 15° C.

The ambient temperature is to be measured by means of several thermometers placed at different points around and half-way up the machine at a distance of 1 to 2 meters, and protected from drafts and abnormal heat radiation. To this end the thermometers are to be immersed in oil in a suitable heavy metal cup, for example, a massive metal cylinder with a hole drilled partly through it. This hole is filled with oil, and must be sufficiently deep to insure complete immersion of the bulb of the thermometer. The smallest size of oil cup permitted by the rules consists of a metal cylinder 25 mm. (1 inch) in diameter and 50 mm. (2 inches) high, but the size of the oil cup must be increased with that of the machine under test. The object of thus increasing the size of the oil cup is to avoid errors in the calculations of temperature rise due to the time lag between changes of temperature of the machine and the surrounding air, this time lag being greater the greater the size of the machine.

Where machines are partly below the floor line in pits, the temperature of the armature is referred to a weighted mean of the pit and room temperatures, the weight assigned to each being based on the relative proportions of the machine in and above the pit. The temperature of the portion of the field structure constantly in the pit must be referred to the ambient temperature in the pit.

2. RESISTANCE METHOD.—This method consists in the determination of the temperature of windings by measurement of their increase of resistance; when this method is used, careful check readings must be taken by means of thermometers, but without disassembling the machine, in order to increase the probability of revealing the highest observable temperature. Whichever method yields the highest temperature, that temperature shall be taken as the highest observable temperature and a hottest-spot correction of 10° C. added thereto. This method is not permitted in the case of low resistance field coils where the joints and connections form a considerable part of the total resistance.

In the case of resistance measurements the temperature coefficient of copper is to be computed from the formula $1/(234.5 + t)$, where t is the initial temperature in degrees Centigrade. From this it follows that the rise of temperature of a winding is given by the formula

$$\theta = (234.5 + t) \left(\frac{R_{t+\theta}}{R_t} - 1 \right) \quad (40)$$

where

$R_{t+\theta}$ = resistance of winding at $(t + \theta)$ degrees

R_t = resistance of winding at t degrees.

3. IMBEDDED TEMPERATURE-DETECTOR METHOD.—This method involves the use of thermocouples or resistance coils located as nearly as possible at the estimated hottest spot, but is to be used only with coils placed in slots. The thermocouples or resistance coils are built into the machine, and a sufficient number shall be employed to insure locating the hottest spot. They should be placed in at least two sets of locations, one between the coils and core; and one between the top and bottom coils in the case of two-layer windings, or between the coil and wedge in single-layer windings. Detectors of this kind will assume a temperature practically equal to that of the adjacent coils. A correction of 5° C. is to be added to the highest reading in the case of two-layer windings with detectors between coils and between coils and slots; and a 10° correction in the case of single-layer windings, plus 1° C. for each 1000 volts above 5000 volts terminal voltage (single-layer windings are commonly used in alternators, seldom or never in direct-current machines).

183. Heating of Railway Motors.—Operating conditions in the case of railway motors are much more severe than in ordinary motors because of restricted space and the nature of the service. It is therefore good practice to permit higher working temperatures for short periods than in other types of machines. Further, the variable nature of the load makes it more difficult to give a definite rating to railway motors. The *nominal rating* of a railway motor is, therefore, arbitrarily defined as the mechanical output at the car or locomotive axle, measured in kilowatts, which causes a rise of temperature above the surrounding air, by thermometer, not exceeding 90° C. at the commutator and 75° C. at any other normally accessible part, after one hour's continuous run at its rated voltage on a stand with the covers arranged to secure maximum ventilation without external blower. The rise in temperature, as measured by resistance, shall not exceed 100° C. The statement of the nominal rating must also include the corresponding voltage and armature speed.

The *continuous ratings* of a railway motor are defined as the inputs in amperes at which it may be operated continuously at one-half, three-fourths and full voltage respectively, without exceeding the specified temperature rises tabulated below, when operated on stand test with the motor covers and cooling system, if any, arranged as in service. The system of ventilation must be defined, and if cooling is by means of forced draft the volume of air on which the rating is based must be given.

TABLE OF MAXIMUM TEMPERATURES AND TEMPERATURE RISES

Class of insulating materials	Maximum observable temperature of windings				Temperature rises of windings on stand test	
	Short periods		Continuous		Continuous	
	By therm.	By resist.	By therm.	By resist.	By therm.	By resist.
A ₂	100	125	85	110	65	85
B.....	115	145	100	130	80	105

The temperatures obtained on stand test, with current and voltage adjusted to give losses equal to those in service will

Rating	Service	Type	Speed	Temperature rise, degrees Centigrade						
				Windings and bearings		Commutator				
				Full load	25 per cent. overload	50 per cent. overload momentary	Full load	25 per cent. overload	50 per cent. overload momentary	
Small; ¼ h.p. and less 115 and 230 volts	Continuous	Open Enclosed	1120 and 1700 r.p.m.	40	No guarantee	No guarantee	40	No guarantee	No guarantee	50 per cent. overload momentary
		Open	Constant, adjustable and varying	40	55	No guarantee	45	60	No guarantee	No guarantee
Large; all over ¼ h.p.	Continuous	Protected Enclosed	Constant, adjustable and varying	50	No guarantee	55	No guarantee
		Open, protected and enclosed	Constant, adjustable and varying (fibrous insulation)	55	No guarantee	60	No guarantee
	Intermittent. No time rating less than 15 minutes	Open, protected and enclosed	Varying (non-combustible insulation)	50	No guarantee	55	No guarantee
Varying	Open, protected and enclosed	Adjustable	75	80
				55 ¹	No guarantee	60 ¹	No guarantee

¹ For machine tool practice, field coils to be rated for continuous service.

be higher than in actual service because of the absence of the ventilation due to the motion of the car or train. In general, the temperature rise in actual service will be from 75 to 90 per cent. of the temperature rise on stand test in the case of enclosed motors, the losses being the same in both cases; and from 90 to 100 per cent. in ventilated motors.

184. Temperature Specifications of Electric Power Club.—The Electric Power Club, composed of representative manufacturers, successor to the American Association of Motor Manufacturers, has adopted the following specification for direct-current generators:

“The temperature rise shall not be more than 40° C. on all windings, and 45° C. on commutator after a run of normal rated current and voltage for a time sufficient to give approximately stationary temperatures.

After a 25 per cent. overload in current at rated voltage for two hours immediately following the normal load run, the temperature rise on the winding should not exceed 55° C. and on the commutator 60° C. by thermometer. The machine should also be capable of standing a momentary overload of 50 per cent.”

Specifications for direct-current motors of the open, protected and enclosed types, and for various classes of service, are summarized in the table on page 333.

185. Output Equation.—A definite relation, originally derived by G. Kapp, exists between the rating, speed and dimensions of the armature. This relation, when expressed in algebraic form, is commonly referred to as the *output equation*. Thus, let

E_t = rated terminal voltage

i_a = rated armature current

ψ = ratio of pole arc to pole pitch

q = ampere-conductors per unit length of armature periphery.

Since

$$E_t = \frac{p}{a} \frac{\Phi Z n}{60 \times 10^8} \text{ (nearly)}$$

and

$$\Phi = B_o b l = \frac{\pi d \psi}{p} B_o l \text{ (nearly)}$$

the power output of the machine in kilowatts is

$$KW = \frac{Ei_a}{1000} = \frac{\pi^2\psi B_g q}{60 \times 10^{11}} d^2 l n = \xi d^2 l n \quad (41)$$

where

$$\xi = \frac{\pi^2\psi B_g q}{60 \times 10^{11}} \quad (42)$$

is called the *output coefficient*. The numerical value of this coefficient depends upon the "design constants" of the machine, ψ , B_g and q , but principally upon B_g and q since the range of values of ψ is limited. B_g is clearly a measure of the degree of utilization of the magnetic material of the machine; similarly, q is in part a measure of the specific utilization of armature copper, for it is closely related to the thermal characteristics, as has been shown by Adams.¹ Thus let q be expressed in ampere-

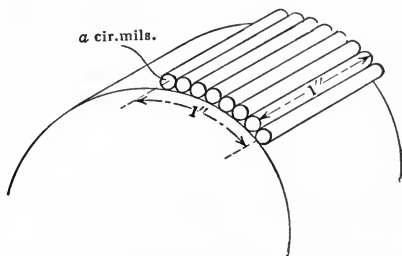

FIG. 286.—Calculation of copper loss per sq. in. of armature surface.

conductors per inch of armature periphery, and let h be the current density in the armature conductors expressed in circular mils per ampere. Let Fig. 286 represent a portion of the armature surface (shown as a smooth-core type for convenience) of 1 inch square. Each conductor will carry a current of $\frac{i_a}{a}$ amperes, and its cross-section will be $\frac{i_a}{a} h$ circular mils; its resistance per inch of length is

$$r = \rho \frac{\text{length}}{\text{area}} = 1 \times \frac{1}{\frac{i_a}{a} h} = \frac{a}{i_a h} \text{ ohms}$$

¹Trans. A.I.E.E., Vol. XXIV., p. 653, 1905.

since the specific resistance of copper at the working temperature of the armature is very nearly 1 ohm per circular mil-inch. The i^2r loss per conductor is then

$$\left(\frac{i_a}{a}\right)^2 \frac{a}{i_a h} = \frac{i_a}{ah} \text{ watts}$$

But the number of conductors per inch of armature periphery is $\frac{q}{i_a/a} = \frac{aq}{i_a}$, hence the i^2r loss per sq. in. of armature surface is

$$\frac{i_a}{ah} \times \frac{aq}{i_a} = \frac{q}{h} \text{ watts per sq. in.} \quad (43)$$

The value of q varies from about 400 in machines of 20 kw. or less, up to about 800 to 850 in machines of 1000 kw. capacity. The ratio q/h (watts per sq. in. due to copper loss) is generally in the neighborhood of unity for ordinary peripheral velocities of 2500 feet per minute, but may be as high as 2.5 in large machines running at high peripheral speeds (6000 feet per minute) where the ventilation is more effective. Values of B_g range from about 40,000 lines per sq. in. in small machines up to 60,000 lines per sq. in. in large machines. The value of ξ generally lies between 0.000015 (small machines) and 0.000056 (large machines).

186. Heating and Cooling Curves.—The energy losses in any machine are converted into heat and cause a rise of temperature whose final value depends upon the heat capacity of the materials of the structure and upon the facility with which the heat may be radiated or otherwise dissipated. The temperature will become stationary when the rate of heat generation becomes equal to the rate of dissipation.

It is of interest to derive the law of heating and cooling of a homogeneous body for the reason that it throws light on the conditions obtaining in the more complex structure of a generator or motor.

Let

Q = heat generated per second, in kg-calories

s = specific heat of the substance = amount of heat required to raise 1 kg. 1° C.

W = weight of the body in kg.

A = radiating surface in sq. cm.

α = coefficient of cooling = amount of heat in kg-cal.

dissipated per second per sq. cm. of radiating surface per degree difference of temperature between body and surrounding medium

θ = temperature of body in degrees Centigrade

θ_1 = temperature of surrounding medium in degrees Centigrade.

1. Heating of the body.

In a time dt the temperature will increase by $d\theta$ degrees. During this interval the heat liberated amounts to Qdt kg-calories, and the body absorbs $sWd\theta$ kg-calories. The remainder will be dissipated, to the amount $A\alpha(\theta - \theta_1)dt$ kg-calories, so that

$$Qdt = sWd\theta + A\alpha(\theta - \theta_1)dt \quad (44)$$

Transposing,

$$dt = \frac{sWd\theta}{Q - A\alpha(\theta - \theta_1)}$$

Assuming that $\theta = \theta_1$ when $t = 0$,

$$\int_0^t dt = sW \int_{\theta_1}^{\theta} \frac{d\theta}{Q - A\alpha(\theta - \theta_1)}$$

which gives

$$\theta - \theta_1 = \frac{Q}{\alpha A} \left(1 - e^{-\frac{\alpha A}{sW} t} \right) \quad (45)$$

When $t = \infty$,

$$(\theta - \theta_1)_{t = \infty} = \frac{Q}{\alpha A} \quad (46)$$

and this is the limiting temperature rise of the body. The last equation (46) may be written

$$Q = \alpha A(\theta - \theta_1)_{t = \infty} \quad (47)$$

which expresses the fact that when the temperature becomes stationary the rates of heat production and dissipation are equal.

2. Cooling of the body.

In this case no heat is being developed, consequently $Q = 0$ and the fundamental equation becomes

$$0 = sWd\theta + A\alpha(\theta - \theta_1)dt \quad (48)$$

If the temperature is Θ degrees when $t = 0$,

$$\int_0^t dt = -sW \int_{\Theta}^{\theta} \frac{d\theta}{A\alpha(\theta - \theta_1)}$$

which gives

$$\theta - \theta_1 = (\Theta - \theta_1)\epsilon^{-\frac{\alpha A}{sW}t} \quad (49)$$

as the equation of the cooling curve. If $\Theta - \theta_1 = (\theta - \theta_1)_{t=\infty} = \frac{Q}{\alpha A}$, that is, if the temperature at the beginning of cooling is equal to the limiting temperature at the end of the heating period,

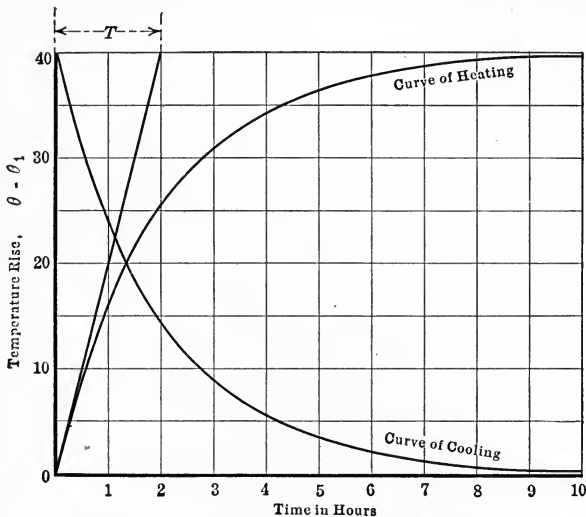

FIG. 287.—Heating and cooling curves.

the equation of the cooling curve is the same as the variable part of the heating equation, but with a change of sign. Hence, in this case, the heating and cooling curves are of the same logarithmic shape, but one is turned upside down with respect to the other, as shown in Fig. 287.

Differentiating the heating equation

$$\theta - \theta_1 = \frac{Q}{\alpha A} \left(1 - \epsilon^{-\frac{\alpha A}{sW}t} \right)$$

and substituting $t = 0$ in the result, the slope of the curve at the origin is found to be

$$\left(\frac{d\theta}{dt} \right)_{t=0} = \frac{Q}{sW} \quad (50)$$

that is, dependent upon the mass and material of the body, but not upon its cooling area or the nature of the radiating surface. In fact, at the first instant, all of the heat is absorbed and none of it is radiated; hence, the slope of the curve at the origin gives the rate at which the temperature would rise if all the heat were absorbed. If the temperature continued to rise at this rate, the limiting temperature rise, $\frac{Q}{\alpha A}$, would be reached in a time

$T = \frac{sW}{\alpha A}$ seconds; T is called the *time constant* of the body.

The heating equation can then be written

$$\theta - \theta_1 = \frac{Q}{\alpha A} \left(1 - e^{-\frac{t}{T}}\right)$$

To substitute numerical values in the above equations, the following relations obtain

$$Q = 0.2386 \times (\text{loss in kw.}) \text{ kg-cal. per sec.}$$

$$= 0.527 \times (\text{loss in kw.}) \text{ lb-cal. per sec.}$$

$$s = 0.11 \text{ for iron}$$

$$s = 0.09 \text{ for copper.}$$

The value of α may be found from the experimentally determined¹ fact that when air is blown across the bare (or thinly varnished) surface of an iron core its surface temperature will rise 1° C. when the radiation is 0.0038 (1 + 0.25 v) watts per sq. cm. of surface, where v is the velocity of the air in meters per second; this is equivalent to 0.0245 (1 + 0.00127 v) watts per sq. in. if v is in feet per minute. From this it follows that

$$\alpha = 0.906 (1 + 0.25v) \times 10^{-6} \text{ kg. cal. per sec. per sq. cm. per } 1^\circ \text{ C.} \quad (51)$$

where v is given in meters per second; or

$$\alpha = 12.89 (1 + 0.00127v) \times 10^{-6} \text{ lb-cal. per sec. per sq. in. per } 1^\circ \text{ C.} \quad (52)$$

where v is expressed in feet per minute.

The experiments of Ott also showed that if the surface of the core is coated with a thick double layer of varnish the radiation

¹Ludwig Ott, London Electrician, 1907, p: 805.

is 0.0030 (1 + 0.107 v) watts per sq. cm. per 1° C. rise of surface temperature, v being in meters per second; or 0.0194 (1 + 0.00054 v) watts per sq. in. per 1° C, v being in feet per minute.

Temperature rise computed from the above formula will not agree in general with the observed rise in actual machines because it neglects the transfer of heat from the winding to the core, or *vice versa*; likewise, the irregular distribution of heat evolution and the thermal capacity of the insulation. But in general terms it will be true that the ultimate rise of temperature can be expressed by the equation

$$\theta - \theta_1 = \text{constant} \times \frac{\text{watts dissipated}}{\text{radiating surface}} \quad (53)$$

where the constant is in each case to be determined by experiment.

187. Heating of the Armature.—The experimental results of Ott referred to above may be changed to a form applicable to the rotating part of the machine. Taking the value of the radiation for bare or thinly varnished surfaces, the temperature rise is given by

$$\theta - \theta_1 = \frac{w}{a} \frac{460}{1 + 0.25v} \quad (54)$$

where

w = total watts dissipated

a = total radiating surface, sq. cm.

v = peripheral velocity of armature, meters per second

while for a heavily varnished surface

$$\theta - \theta_1 = \frac{w}{a} \frac{333}{1 + 0.107v} \quad (55)$$

Accordingly, the rise of temperature for a radiation of 1 watt per sq. cm. is found by putting $\frac{w}{a} = 1$. The temperature rise (in degrees Centigrade) for a radiation of 1 watt per sq. in., expressing v in feet per minute, is

$$\frac{71.3}{1 + 0.00127v} \text{ for a bare surface}$$

$$\frac{52}{1 + 0.00054v} \text{ for a heavily varnished surface}$$

Other writers give the value of this constant as follows:

	Metric units	English units
Kapp.....	$\frac{550}{1 + 0.1v}$	$\frac{85}{1 + 0.00051v}$
Arnold.....	$\frac{300}{1 + 0.1v}$	$\frac{46.5}{1 + 0.00051v}$
Esson.....	$\frac{354}{1 + 0.0006v}$	
Wilson.....	$\frac{640}{1 + 0.18v}$	$\frac{99}{1 + 0.00091v}$
Thompson....	$\frac{645}{1 + 0.3\sqrt{v}}$	$\frac{100}{1 + 0.0213\sqrt{v}}$

The above expressions are embodied in Fig. 288, which shows the rise of temperature per watt per sq. in. as a function of the per-

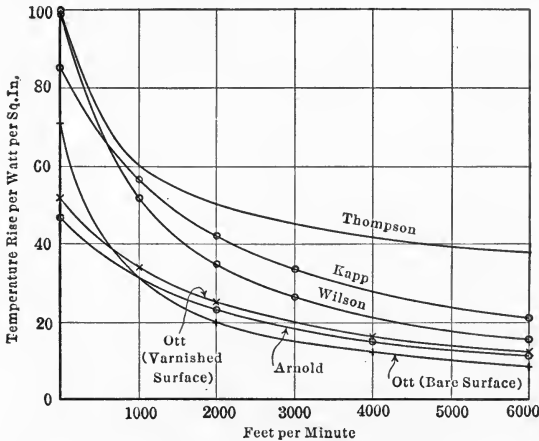

FIG. 288.—Relation between temperature rise and peripheral velocity of armature.

ipheral velocity in feet per second. It will be observed that the curve represented by Arnold's formula lies nearly midway between the two corresponding to Ott's researches, at least for values of v within the usual limits of practice.

It should be noted that all of the above formulas for computing rise of temperature are more or less uncertain, unless applied to a machine of the same type as that from which the constants were experimentally determined. A large part of the differences between the curves of Fig. 288 is due to the fact that there is no

absolute agreement as to what constitutes the radiating surface. Some writers specify the outer cylindrical surface only, but including the surface of the end connections as well as of the core; others include the exposed sides of the core in addition to the outer cylindrical surface. Evidently all exposed surfaces are useful in radiating heat, but not to the same extent. The magnitude and direction of the flow of heat from the interior to the exterior of a mass will depend upon the heat conductivity in different directions; and since the conductivity along the laminations is much greater than across them (Ott found it to be from 50 to 100 times greater) it follows that unless the core is very deep the greater part of the heat will be dissipated from the cylindrical surface. It has been pointed out¹ that a rational equation for the rise of temperature of an armature should be of the form

$$\theta - \theta_1 = \frac{w}{\Sigma a_1 + c \Sigma a_2} \cdot \frac{C}{1 + bv} \quad (56)$$

where

Σa_1 = sum of cylindrical cooling surfaces

Σa_2 = sum of end surfaces

c = a variable coefficient less than unity.

The value of c will be smaller the greater the ratio of heat conductivity along the laminations to that across them.

The Arnold formula for rise of armature temperature is

$$\theta - \theta_1 = \frac{w}{a} \frac{(40 \text{ to } 70)}{1 + 0.00051 v} \quad (57)$$

where a and v are expressed in square inches and feet per minute respectively. The numerical coefficient in the numerator is to be taken near the lower limit of its range when the ventilation is good. In using this formula, however, it should be noted that w does not include the watts dissipated in the end connections, nor does a include their surface; in other words, the rise of temperature of the armature core is to be distinguished from that of the end connections. Consequently, to estimate the rise of temperature of the core, the value of w to be inserted in the formula is

¹ Ott, London Electrician, 1907, p. 805.

$$w = \text{total core loss} + \frac{\text{embedded length of winding}}{\text{total length of winding}} \times i_a^2 r_a \quad (58)$$

The value of a recommended by Arnold is the cylindrical surface of the core, plus the two end surfaces, plus half the lateral area of the walls of the ventilating ducts; or (Fig. 289)

$$a = \pi dl + \pi d_{aver} h (2 + n_v) \quad (59)$$

In the case of the end connections,

$$\left. \begin{aligned} w &= \frac{\text{free length of winding}}{\text{total length of winding}} \times i_a^2 r_a \\ a &= 2\pi dl_e \end{aligned} \right\} \quad (60)$$

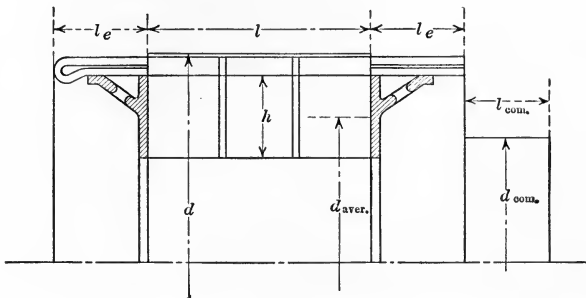

FIG. 289.—Dimensions of radiating surfaces.

In semi-enclosed machines the temperature rise is about 50 per cent. greater than that given by the above formula, and in enclosed machines it is about twice as great as given by the formula.

188. Heating of the Field Coils.¹—The field coils are heated not only by the $i^2 r$ losses that occur in them but also by the losses in the pole faces caused by eddy currents, and by radiation from the armature. The heat is dissipated in three ways: by convection in the surrounding air; by conduction through the pole cores and yoke; and by direct radiation. The temperature inside the coil varies from point to point in a manner depending upon the depth of the winding and upon the nature of the insulation, being highest near the middle of the cross-section of the coil and lowest on the exposed surface. Impregnated coils run cooler than ordinary coils, for the insulating compound is a better

¹ For the results of elaborate studies of field coil heating refer to articles by Neu, Levine and Havill, *Electrical World*, Vol. XXXVIII, p. 56, 1901; and by Ott, *London Electrician*, 1907, p. 805.

heat conductor than the air it replaces. Measurement of the rise of temperature by the increase of resistance gives the *average* rise of temperature of the winding as a whole, the *maximum* rise at the hottest point being from 12 to 20 per cent. greater than the average rise. The average rise of temperature of the entire winding is from 40 to 60 per cent. greater than the average rise of temperature of the exposed surface; the latter is determined by taking the mean of thermometer readings at the middle and ends of the exposed cylindrical surface.

Formulas for computing the rise of temperature of field coils are of the form

$$\theta - \theta_1 = C \frac{\text{watts lost in coil}}{\text{radiating surface of coil}} \quad (61)$$

Different writers assign various values to the constant C , depending upon the selection of what constitutes the radiating surface. Obviously, C means the rise of temperature due to a radiation of 1 watt per unit area. If the radiating surface is expressed in square inches and is taken to mean the outer cylindrical surface exclusive of the exposed end, the value of C for open type machines, and under standstill conditions, is from 70 to 80, with an average of 75. The value of C decreases with increasing peripheral velocity of the armature, due to fanning action, by approximately 5 per cent. per 1000 feet per minute, or

$$C = 75(1 - 0.00005v) \quad (62)$$

where v is peripheral velocity in feet per min. This is an average value, the decrease of C being somewhat greater if the coils are short, because of the cooling effect of the yoke; and somewhat less if the coils are long. In machines of the protected type C is approximately 50 per cent. greater than the above value, and in enclosed machines from two to three times greater than given by equation (62).

Field coils of the ventilated type of construction are made of concentric parts with an open space of about $\frac{1}{2}$ inch between them. The greater surface presented to the air by reason of this construction permits of increased radiation; however, the internal surfaces of the ducts are not as effective as an equal area on the outside. For a given temperature rise the ventilated coil will

radiate about 50 per cent. more watts per sq. in. than an ordinary coil; or, what amounts to the same thing, C may be taken as equal to 50.

189. Heating of the Commutator.—The commutator is heated by the losses due to brush friction, P_{bf} , and by the flow of the current across the contact resistance between commutator and brushes. The rise of temperature can be computed from the formula

$$\theta - \theta_1 = 20 \frac{W}{A} \frac{1}{1 + 0.00051v} \quad (63)$$

where

W = total loss at the commutator

$A = \pi d_{com} l_{com}$

v = peripheral velocity of commutator in feet per minute.

190. Rating of Enclosed Motors.—If a motor of the open type is converted into one of the enclosed type, it is clear that its rating must be reduced to avoid excessive temperature rise. Experience shows that a reduction in horse-power rating of about 30 per cent., accompanied by an increase of speed of 20 per cent. will give a temperature rise within standard limits. The reduction in horse-power rating decreases the current and consequently the i^2r losses, and the increase of speed permits a reduction of the flux per pole, thereby lowering the excitation loss and the core loss. The core loss decreases notwithstanding the increase of speed, for the effect of reduced flux density more than outweighs the effect of increased frequency of the magnetic reversals (see Fig. 281); the core loss varies nearly as the square of the flux density, and approximately as the first power of the speed since the hysteresis loss is always greater than the eddy current loss.

PROBLEMS

1. A 220-volt shunt motor has an armature resistance of 0.44 ohm and a shunt field resistance of 169 ohms. When running without load the armature current is 1.5 amp. and the speed is 997 r.p.m. Find (a) the stray power loss and the loss in the shunt winding; (b) the true efficiency, the efficiency of conversion and the electrical efficiency when the armature current has its full-load value of 25 amp., assuming that the stray power loss remains constant at its no-load value.

2. Find the efficiency of the above motor when the armature current has values of 5, 10, 15, 25 and 35 amp., and plot a curve showing the relation between efficiency and horse-power output.

3. At what value of armature current will the above motor develop its maximum efficiency, and what are the corresponding values of maximum efficiency and horse-power output?

4. If the rated horse-power output of the above motor is obtained when the armature current is 25 amp., what will be the armature current at $\frac{1}{4}$, $\frac{1}{2}$, $\frac{3}{4}$, and $1\frac{1}{4}$ times rated load? Plot a curve showing the relation between armature current and per cent. of rated load.

5. If it is required to design a shunt motor that shall develop a full-load efficiency of 92 per cent. and in which maximum efficiency shall occur at $\frac{7}{8}$ of full-load, what must be the variable and fixed losses in terms of full-load rating? What will be the maximum efficiency under these conditions?

6. From the results of Problem 4, compute the all-day efficiency of the motor if it operates at $\frac{1}{4}$ load for 2 hr., at $\frac{1}{2}$ load for 3 hr., at $\frac{3}{4}$ load for 3 hr., at full-load for $1\frac{1}{2}$ hr. and at $1\frac{1}{4}$ times full-load for $\frac{1}{2}$ hr., the working day comprising 10 hr.

7. If the machine of Problem 1 is operated as a shunt generator with a terminal voltage of 220 volts and an armature current of 25 amp., what will be its true efficiency, its efficiency of conversion and its electrical efficiency, assuming that the stray power loss is the same as in Problem 1?

8. The total current output of the machine whose commutator and brushes have the dimensions specified in Problem 7, Chap. II (p. 87) is 90 amp. Find the total loss at the commutator. If the active length of the commutator is 5.5 in., what will be its probable rise of temperature under full-load conditions?

9. A 220-volt shunt motor takes a field current of 1.3 amp. when the machine has been standing idle for several hours in a room which has a temperature of 30° C. After running under load for several hours the shunt field current is found to be 1.1 amp. Find the average rise of temperature of the field winding.

10. In making the preliminary design of a 6-pole 100-kw. 250-r.p.m. generator, it is decided to use an air-gap density of 52,000 lines per sq. in. and 600 amp.-conductors per in. of periphery. If the ratio of pole arc to pole pitch is to be 0.7, and if the pole faces are to be square, what must be the diameter and the length of the armature core?

CHAPTER XI

BOOSTERS AND BALANCERS. TRAIN LIGHTING SYSTEMS

191. Boosters.—A *booster* is a dynamo-electric machine whose armature is connected in series with a circuit, its generated e.m.f. being added to or subtracted from that of the circuit, depending upon the polarity of its excitation. Boosters may be driven by any form of prime mover, but are generally direct-connected to a shunt motor taking current from constant potential mains.

192. The Series Booster.—An obvious use for a booster is to raise the voltage of a generator, or of a section of the bus-bars of a central station, by an amount sufficient to compensate the ohmic drop in a feeder supplying a distant load, in case the load is of such character as to require the same voltage as receiving devices at or near the source of supply. Since the line drop is directly proportional to the current, the voltage of the booster should also be proportional to the current; in other words, the booster should have an external characteristic consisting of a straight line through the origin. It is impossible to exactly realize this form of characteristic without auxiliary devices, but it may be approximated sufficiently closely for practical purposes by designing the booster as a series-wound generator with flux densities well within the point of magnetic saturation. The hysteresis effect illustrated in Fig. 104, p. 116, is especially objectionable in boosters, and should be reduced to a minimum. Further, if the excitation is of such character that the main flux is subject to wide variations, the magnetic circuit must be laminated throughout in order that eddy currents set up by a change in the flux may not be of sufficient magnitude to retard the change of flux and so make the machine sluggish in its action.

The compensation, by means of a series booster, of the drop

of potential of a circuit due to its ohmic resistance is equivalent to a complete cancellation of the resistance of the circuit. Ordinarily, if the resistance of a circuit is to be reduced, the reduction would be made by an increase of the cross-section and therefore of the weight and cost of the line. Up to a certain point, which may readily be computed for a given set of conditions, it will be cheaper to save energy by adding copper than to install a booster equipment; beyond that point the booster will be more economical.

The apparent cancellation of the resistance of a circuit by means of a series booster is sometimes utilized in electric railways employing a ground return to mitigate the *electrolysis* of underground structures such as water and gas mains, telephone cables, and the like. The return circuit of the ordinary street railway system consists of the track and the surrounding earth, the current dividing between these paths in the inverse ratio of their resistances. Even with well-bonded tracks a considerable flow of current may take place through the earth along paths of low resistance afforded by underground metallic structures, resulting in damage wherever stray currents leave these paths to return through moist earth to the track or to the grounded bus at the power house. It is becoming standard practice to minimize the danger of electrolysis in such systems by installing insulated *negative feeders* or cables which connect points along the track directly to the negative bus of the generating station, thereby draining the track current away from the stray paths. These negative feeders are clearly the more effective the lower their resistance. If a series booster is now connected in such a feeder so that its e.m.f. acts in the direction from the track to the negative bus, the equivalent resistance of the feeder may be reduced nearly to zero, and most of the current will return to the station by way of the feeder. Boosters used in this way are called *negative* or *track-return* boosters.

193. The Shunt Booster.—In constant-potential systems in which the load changes gradually, but covers a range from a very small to a considerable value, it is common practice to use a storage battery in parallel with the bus-bars. The battery may then be used to carry the entire load at times of light load, and in parallel with the generator at the time of peak load. At

other times the battery takes charging current from the generator, thus insuring a fairly uniform load on the generator during its working period, with consequent economy in cost of fuel: In a system of this kind a so-called *shunt booster* is used to force charging current into the battery against the latter's counter e.m.f., the connections being shown in Fig. 290. The field winding of the booster is connected across the main bus-bars, never across its own armature, hence the machine is really separately excited. The booster armature is in series with the battery during the charging period, and is called upon to supply a relatively small e.m.f., hence the above connection of the field winding. The booster voltage is manually controlled by means of the field rheostat, adjustment being made when the readings of the am-

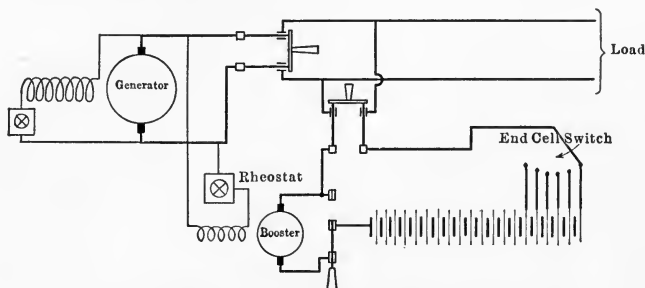

FIG. 290.—Connections of shunt booster.

meters indicate that it is necessary. By inserting a reversing switch in the field circuit, or by using a reversing rheostat, the booster e.m.f. may be added to that of the battery, thereby assisting the battery to discharge if its voltage is low, or if the demand for current is unusually heavy.

A lead storage battery when discharged to the permissible limit gives 1.8 volts per cell, and when fully charged requires an impressed e.m.f. of 2.65 volts per cell to give it the "overcharge" that is periodically required to keep it in good condition. If, therefore, the voltage of the system is E , the total number of cells required is $E/1.8$ to provide for the contingency that the battery alone, when nearly exhausted, may be used to carry the load. At the end of a prolonged charge the battery voltage will then have risen to $2.65 \times (E/1.8)$, hence the booster must be

capable of generating $E \left(\frac{2.65}{1.8} - 1 \right) = 0.47E$ volts; thus, in a 110-volt system, the maximum booster voltage will be 52 volts. The design of the booster will then be completely determined when the maximum discharge rate of the battery is known.

The capacity of the motor that drives the booster need be only from two-thirds to three-fourths of the volt-ampere capacity of the booster for the reason that when the latter delivers its maximum current the voltage is low, and when the voltage is highest, during the periods of overcharge, the current must be considerably reduced. The normal, (eight-hour) discharge rate of a lead battery is defined as that current which, flowing uniformly for eight hours, will reduce the battery voltage to the minimum value of 1.8 volts per cell; the current during overcharge should be not greater than one-half of the eight-hour rate.

In Fig. 290 the cells shown at the right-hand end of the battery are the *end-cells* which are cut in and out of circuit by means of an end-cell switch. Their purpose is to adjust the battery voltage to the line requirements to compensate for the changes in voltage due to varying conditions of charge and discharge. Thus, in a 110-volt system, the number of cells required will be $110/1.8 = 61$ when fully discharged; but when a fully charged battery begins to discharge its terminal voltage is 2.15 volts per cell, therefore requiring $\frac{110}{2.15} = 51$ cells. Consequently in such a system 61 cells would be installed, 10 of them as end-cells. The number of end-cells may be reduced if the booster field is provided with a reversing switch, for in that case the booster e.m.f. can be made to oppose that of the battery to a sufficient extent to bring the terminal voltage to the proper value.

194. The Constant-current or Non-reversible Booster.—In isolated plants supplying a lamp load and a fluctuating motor load, as in hotels and office buildings, it is necessary to maintain a constant lamp voltage, and it is permissible or even desirable to allow the voltage of the power circuit to fall when there is a heavy rush of current, as on starting an elevator. Fig. 291 represents a type of installation frequently used in such a case. The shunt field winding of the booster, f , is connected across the constant potential lighting bus and its magnetizing effect is opposed by that of

the series winding, S , as indicated by the arrows. The excitation due to f is normally the greater of the two, and the resultant differential excitation produces a booster voltage that acts in the same direction as the generator, and which is from 10 to 15 volts under normal load conditions. At normal load the adjustments are such that the battery neither charges nor discharges, in other words, the sum of the voltages of generator and booster equals the open-circuit voltage of the battery. The entire lighting and power load is then carried by the main generator. If the motor load is suddenly increased, there is an initial tendency to draw the increased current from the generator, but this results in an increased excitation of the series winding of the booster and a reduction of its generated e.m.f.; the original condition of balanced voltage at the battery terminals is therefore disturbed, and the battery discharges and relieves the generator of the current in

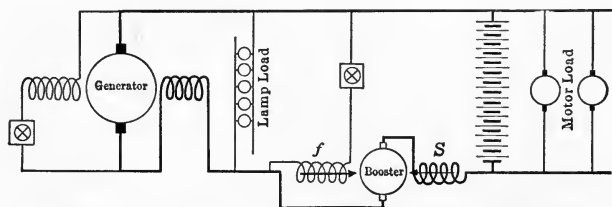

FIG. 291.—Constant-current or non-reversible booster.

excess of the normal amount. Conversely, a decrease of the motor load results in a momentary weakening of the series excitation of the booster and a charging current therefore flows into the battery. The current through the armature and series field of the booster is therefore not constant, as the term constant-current booster might imply, but it is substantially so, the total variation of a few per cent. being no more than is sufficient to cause the battery to take up the fluctuations of current above and below the average value. When a storage battery charges or discharges, its terminal voltage rises or falls, respectively, by an amount very nearly proportional to the current; thus, if the current is equal to the eight-hour rate, the change of voltage is 0.05 volts per cell, and at the one-hour rate¹

¹ If the capacity of a storage battery is C_8 amp-hr. when discharged at the 8-hr. rate (see p. 350), its capacity is greatly decreased if it is discharged at

(equivalent to four times the current at the eight-hour rate), the variation is 0.2 to 0.21 volts per cell, provided the battery is initially fully charged. The function of the booster is then to produce a change of voltage at the battery terminals corresponding to the charge or discharge rate demanded by the load. For example, assume that the voltage of the motor circuit is 230, requiring, say, 115 cells when charged to a normal voltage of 2 volts per cell. If the load calls for a supply of current equivalent to the eight-hour discharge rate of the battery, over and above the normal supply of I_{aver} amperes, the booster voltage must be lowered by $115 \times 0.05 = 5.75$ volts. This can be accomplished by so proportioning the series winding that an increase of the current through it from I_{aver} to $I_{aver} (1 + p)$ will produce the necessary change in field excitation, where $p \times 100$ is the prescribed percentage variation of booster current. The linear variation of booster voltage of course requires that the magnetic circuit be worked on the straight part of the magnetization curve (see Fig. 100, p. 113). Change of battery voltage with varying conditions of charge can be compensated by manual regulation of a rheostat in the shunt field of the booster; but in the type of service to which the non-reversible (and other automatic) boosters are adapted, the fluctuations of load causing alternate charge and discharge are so rapid that the general condition of the

greater rates. Thus, if the current is such that the voltage per cell falls to 1.8 volts in 1 hr., the current is said to be the 1-hr. rate, and the capacity falls to $\frac{1}{2} C_8$ amp-hr. The reduced capacity is due to the fact that the high rates of discharge produce chemical changes of great velocity in a thin surface film of the active material, thereby preventing the electrolyte from penetrating to fresh material. The relation between discharge rate (n) and the corresponding capacity in amp-hr. (C_n) is given approximately by the formula

$$C_n = \frac{C_8}{2} \sqrt[3]{n}$$

(See data in Storage Battery Engineering, by Lamar Lyndon, 3d ed., p. 98, and Foster's Electrical Engineers' Pocketbook, 7th ed., 1913, p. 875.)

If i_8 is the current corresponding to the 8-hr. rate, and i_n the current corresponding to the n -hr. rate, it is clear that $C_8 = 8i_8$ and $C_n = ni_n$; whence, substituting the above approximate relation between C_n and C_8 , it follows that

$$i_n = \frac{4i_8}{\sqrt[3]{n^2}} \text{ (nearly)}$$

battery changes very little. The non-reversible booster is suited to systems in which the average motor load is small and the fluctuations are considerable.

195. Reversible Booster.—In systems in which it is not desirable that battery discharge shall be accompanied by a drop of voltage of the power circuit, as in a railway system having a large average load, the *reversible* booster shown diagrammatically in Fig. 292 is frequently used. It differs from the non-reversible booster in that the current through its armature is not unidirectional, though in both types the shunt and series field windings are differentially connected. The object of the booster is to hold the load on the generator at a constant value equal to the average load on the system, leaving the battery to take up the fluctuations. It is adapted to systems in which the average load is large compared with the range of the fluctuations.

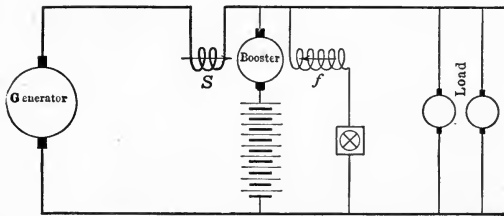

FIG. 292.—Differential or reversible booster.

Referring to Fig. 292, the battery is so designed that its open circuit voltage is equal to that of the system; consequently, when the load on the system has its normal (average) value, the battery must neither charge nor discharge, and the current through the shunt field of the booster must be adjusted so that its magnetizing effect exactly neutralizes that of the series winding *S*. With increased demand on the line there is a slight increase of current through *S*, and a resultant magnetization of the booster in such a direction that the generated e.m.f. acts in the same direction as the battery; discharge of the battery then takes place. The e.m.f. generated in the booster armature must therefore be equal to the drop of battery voltage that corresponds to the discharge rate demanded by the load, plus the ohmic drop in the armature of the booster itself. On the other hand, if the load

falls below normal the shunt winding overpowers the series winding, and the booster voltage is added to that of the generator, with the result that a charging current flows into the battery. The capacity of the booster is determined by the fact that maximum current and maximum e.m.f. occur simultaneously.

Although the open-circuit voltage of the battery is nominally equal to that of the generator and of the system, its actual voltage may vary over a considerable range, depending upon the state of the battery charge. To compensate these changes the excitation of the shunt field must be adjusted by hand regulation of a rheostat in series with the shunt winding.

196. Auxiliary Control of Boosters.—Both the reversible and the non-reversible boosters described in Articles 194 and 195 have the disadvantage that a given change of current in the series coil of the differential winding produces a definite voltage, without regard to the fact that the change of battery voltage corresponding to each rate of charge or discharge varies with the condition of the battery; that is to say, a given change of current in the series winding of the booster will not always automatically result in the desired rate of charge or discharge. Moreover, the heavy current that must be handled by the series winding requires a conductor of large cross-section and a machine frame of excessive dimensions and weight per kilowatt of capacity. To obviate these difficulties there have been developed several automatic systems that regulate the battery by external means, and in which the booster has a simple shunt winding. These systems have practically superseded the types of differential boosters described above.

197. The Hubbard Counter E.M.F. System (Controlled by the Gould Storage Battery Co.) is shown diagrammatically in Fig. 293. The field coil f of the booster B is in series with the armature of a small motor-driven exciter E , the field of the latter being in turn excited by the main generator current, or fractional part thereof. The adjustments are so made that when the load has its average value the exciter E produces an e.m.f. equal and opposite to that of the line. There is, therefore, no current through the booster field winding, no e.m.f. is generated in the booster armature, and the battery, which has a normal voltage equal to that of the line, neither charges nor

discharges. An increase of load above the average value results in an increase of the current through the series coil of the exciter, the generated e.m.f. of the latter then exceeds the line voltage, and a flow of current is established through the booster field winding in the proper direction to generate in the booster armature an e.m.f. that assists the battery to discharge.

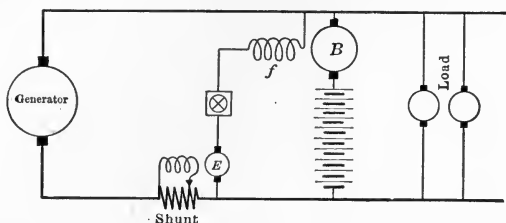

FIG. 293.—Hubbard counter e.m.f. system of booster regulation.

Conversely, a decrease of load weakens the field of the exciter, the polarity of the booster reverses, and the battery then takes a charging current.

198. The Entz System (Electric Storage Battery Co.) of external control for installations of large capacity is illustrated in Fig. 294. The main output of the station passes through a coil *S* consisting of a few turns of heavy strap copper, and produces an

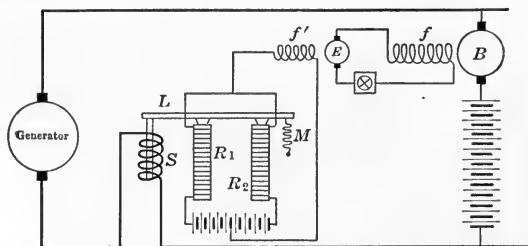

FIG. 294.—Automatic booster regulation, Entz system.

electromagnetic pull on a core attached to one end of a pivoted lever *L*. When the station output has its average value the pull of the electromagnet is balanced by a spring *M* in such a manner that the lever presses upon the piles of carbon plates, *R*₁ and *R*₂, with forces that make the resistances of the two piles equal to each other. The carbon piles are connected to each other at

the top and to one terminal of the field winding f' of a small motor-driven exciter E ; at their lower ends the carbon piles are connected to the terminals of a small auxiliary storage battery, the middle point of which is connected to the other terminal of f' . The armature of the exciter E supplies current to the field winding, f , of the booster B . So long as the resistances of R_1 and R_2 are equal to each other and all the cells of the auxiliary battery are equally charged, there will be no difference of potential between the terminals of f' ; consequently there will be no e.m.f. generated in either the exciter or the booster. Under these conditions the main battery, which has a normal voltage equal to that of the line, will neither charge nor discharge. If the load current increases there will be a tendency to increase the generator current through S , and the pressure on R_1 will be increased; this causes a reduction of the resistance of R_1 and the auxiliary battery will send a current through f' , thereby generating an e.m.f. in the exciter armature and energizing the field of the booster. The field windings of E and B are connected in such order that the booster voltage adds to that of the main battery and a discharge results. In case the load falls below its average value, the spring M overpowers the pull of S and the resistance of R_2 becomes less than that of R_1 , producing a reversed flow of current through f' and, therefore, through f also, so that the booster voltage acts in the same direction as the line voltage and forces charging current into the main battery.

The combination of the resistances R_1 and R_2 , the auxiliary battery and the exciter field winding f' is entirely similar to the circuits of a Wheatstone bridge. The two equal halves of the battery correspond to the ratio arms of the bridge, and R_1 and R_2 to the variable and unknown resistances; the field winding f' is the equivalent of the galvanometer. The polarity of f' is affected by the same causes that make the galvanometer in the bridge circuit deflect one way or the other as the resistances of the bridge arms are varied.

In installations of small capacity the exciter and the auxiliary battery can be dispensed with; the use of the auxiliary battery is not absolutely necessary in any case, for the main battery, or a part of it, may be used directly. The purpose of the auxiliary battery is to avoid imposing unequal loads upon individual cells

of the main battery. If the exciter is omitted, the connections shown leading to f' are transferred to f , but this can be done only when the capacity of the booster and the magnitude of its field current are small; the size of the carbon piles is limited by the fact that the practically constant current through S can produce only a narrow range of pressure variation on the carbon plates, hence the unbalancing of the bridge circuit can produce only moderate current through circuit f' (or f).

199. The Bijur System (General Storage Battery Co.) of external control, illustrated in Fig. 295, also utilizes the principle of the Wheatstone bridge, or potentiometer circuit.

The equal ratio arms R_1 and R_2 , connected in series across the line, are each provided with a series of taps connected to a set of contact points of graduated lengths, as at P_1 and P_2 , which dip in or out of the small troughs of mercury, Hg , as the lever L is tipped one way or the other by the control magnet S or by the restraining spring. The battery is designed to have a normal open-circuit voltage equal to that of the line, consequently it

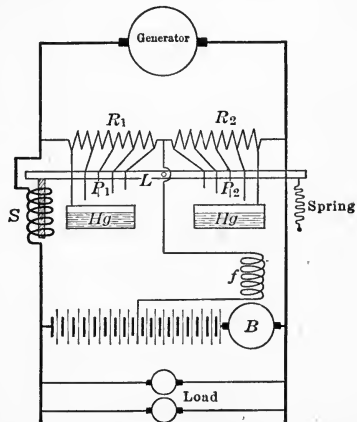

FIG. 295.—Automatic booster regulation, Bijur system.

will neither charge nor discharge when the system is carrying its average load if the control apparatus is adjusted so that under these conditions the lever is horizontal; for the booster field f is then connected to points which have no difference of potential between them, with the result that the booster remains unexcited. An increase of load causes a slightly increased flow of current through S and the resulting counter-clockwise movement of the lever short-circuits more and more of the resistance R_1 as the movement proceeds; this disturbs the balanced condition of the circuit through f and a current will flow through it in such a direction that the generated e.m.f. of the booster causes the battery to discharge. A decrease of load will make the pull of the spring overpower that of the coil S , the lever turns in the

clockwise direction, short-circuiting more or less of R_2 , and the current through f reverses, causing a reversal of the booster e.m.f. and a flow of charging current into the battery. -

The Bijur system differs from other systems of external control in that the latter involve a variation of generator current proportional to the battery charge or discharge, whereas the former causes a response from the battery to the desired extent with a fixed variation of generator current. This follows from the fact that the magnet S and the restraining spring are so proportioned that with a given current through S the pulls due to them balance each other at all points within the range of motion of the lever. The result of this condition of neutral equilibrium is that a change of current that unbalances the forces by an amount just sufficient to overcome the friction of the moving parts will produce a continuous movement of the lever. The excitation of the booster will then go on increasing in the proper direction to relieve the generator of all but the initial variation.

200. Balancers.—Fig. 296 (*a*, *b* and *c*) represents three possible methods of connecting a balancer set for the purpose of maintaining equality, or approximate equality, between the voltages on the two sides of a three-wire system (see Art. 123, Chap. VI). If, with the connections shown in Fig. 296*a*, the load becomes unbalanced, the voltage on the more heavily loaded side will fall while that on the more lightly loaded side will rise. Under these conditions the unit on the heavily loaded side will act as a generator, thereby checking the extent of the voltage drop, while the other unit will act as a motor and so limit the rise of voltage on that side; but the drop in speed of the balancer, due to the load on the motor element, will prevent the generator element from assuming a sufficient part of the unbalanced load to maintain the potential of the neutral as nearly constant as would be the case were the speed to remain constant. A partial compensation of this shift of the neutral may be effected by the system of field connections shown in Fig. 296*b*; in this case the drop in voltage on the heavily loaded side will weaken the field of the motor, thus tending to increase its speed, while at the same time the rise in voltage on the lightly loaded side will strengthen the field of the generator element, thereby tending to still further balance the voltage on the two sides of the system; but the

balance cannot be perfect for the reason that the automatic response of the balancer depends for its inception upon an actual unbalancing of the voltage. Perfect regulation is however possible if the units comprising the balancer are compound-wound as in Fig. 296c, where the series windings are connected in such a manner that the current in the neutral excites the generator cumulatively, while in the motor it acts differentially. The voltage on the heavily loaded side is therefore kept up by the combined effect of increased excitation and increased speed; but whereas in the system of Fig. 296b, this automatic action was dependent upon an unbalanced *voltage*, in the system of Fig. 296c it depends upon the unbalanced *current*, and it is therefore possible to adjust the compounding to maintain perfect equality of voltage on both sides of the neutral.

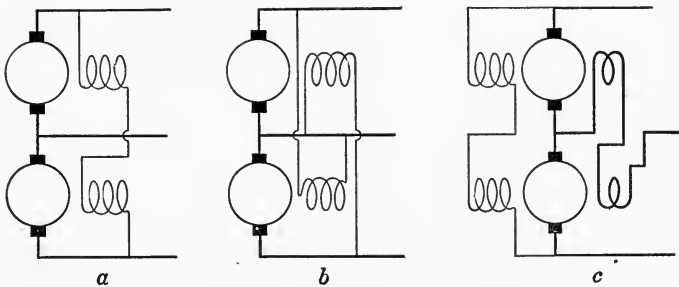

FIG. 296.—Connections of balancer set, three-wire system.

201. Train Lighting.¹—The condition to be satisfied by any system of train lighting is that the lamp voltage shall be maintained at a constant value independently of the number of lamps in use and independently of the speed and direction of motion of the train. In the case of steam railroads three methods of electric lighting are in use:

1. The *straight storage* system, in which each car is equipped with its own storage battery.
2. The *head-end* system, in which a single constant voltage generator placed in the baggage car or on the locomotive supplies current to the entire train.
3. The *axle-lighting* system, in which a small generator, mounted under each car, is driven directly from the axle.

¹ See Trans. A.I.E.E., Vol. XXI, 1903, pp. 129–227.

The straight storage system was used in the earliest installations of electric lighting on steam railroads. It has the disadvantage that the gradual exhaustion of the battery results in inferior illumination toward the end of long runs. The batteries must be charged at terminal or division points, or else be replaced by fully charged batteries.

In the head-end system a single compound-wound generator is driven by a turbine taking steam from the locomotive; in some cases the turbo-generator unit is installed in the baggage car, in others it is mounted on the locomotive. The complete equipment must include storage batteries, generally one for each car, in order that the lights may be operated when the train is parted, as during switching, and at low train speed. The standard (lead) battery equipment for Pullman sleepers consists of 16 cells, corresponding to a nominal lamp voltage of 30 volts. The variation of battery voltage between the extremes of full discharge and full charge requires the use of an automatic regulator in order to maintain constant voltage at the lamps.

In the axle-lighting system the maintenance of constant voltage is complicated by the fact that the speed of a generator positively driven from the car axle will not only vary through wide limits, but the machine must be capable of operating in either direction. Generators of the ordinary types do not possess inherent operating characteristics suitable for such service, and to make a machine of ordinary type conform to the requirements, more or less elaborate regulating devices must be used. Naturally, axle-driven generators must be used in connection with storage batteries in order that the lights may not go out when the train is stationary or when the speed is so low that the generator voltage is less than the normal lamp voltage.

The design of generators for automobile lighting is similar to that of axle-driven machines for train lighting except that there is no need to provide for reversal of the direction of rotation. This follows from the fact that in the former case the generator is driven from the engine, which always runs in the same direction.

202. Voltage Regulation in Train Lighting Systems.—To prevent objectionable variation of the candle-power of the lamps, automatic regulation must be provided to compensate

for the variation of battery voltage between the extremes of full charge and full discharge, and, in the case of axle-driven generators, to overcome voltage variations due to change of speed. The various methods of regulation may be classified as either *mechanical* or *electrical* (or electromagnetic). In some systems the maintenance of constant voltage also involves regulation for constant current output from the generator, hence the latter, when in use, delivers constant power; such regulation is not entirely satisfactory, for it takes no account of the fact that the charging current of a lead battery should "taper," that is, become gradually less, as the battery approaches the fully charged condition. It is possible to arrange the regulatory devices in such a manner that the voltage and current output of the generator are controlled by the battery voltage, or else to make the generator control the line voltage and therefore also that of the battery.

Under the heading of *mechanical* methods of regulation may be included those axle-lighting systems in which the generator voltage is controlled by the slipping of the driving belt, as in the Stone generator, or by a slipping clutch. In these systems the speed of the generator is maintained constant when the load increases above a definite predetermined load which causes slipping to occur. In the Stone system the generator is provided with an automatic device, consisting of a rocker arm on the shaft, for reversing the polarity of the generator terminals when the direction of rotation is reversed; there is also an automatic, centrifugally operated switch arranged to establish the connection between the generator and the battery when the speed and generator voltage have reached predetermined pick-up values, and to break the connection when the speed is below the assigned limit.

Under *electrical* or *electromagnetic* methods of regulation may be grouped all systems in which voltage control is obtained (a) by the automatic variation of resistance in the lamp circuit or in the exciting circuit of the generator; or (b) by the utilization of the armature reaction of the generator to secure the desired characteristics. Examples of these methods are given in the following articles.

203. Resistance Regulation.—Fig. 297 illustrates diagram-

matically a type of automatic regulator which operates by varying the resistance of a pile of carbon disks connected in the main lamp circuit. If the battery voltage E_B rises above normal, as during charging, the lamp voltage E_L tends to increase also. This causes an increased flow of current through the solenoid S_1 , and the movement of its plunger increases the pressure on the carbon pile r , thereby reducing its resistance and permitting an increased flow of current through solenoid S_2 . The motion of the plunger of S_2 then releases the pressure on the carbon pile R , increasing its resistance to a sufficient extent to absorb the greater part of the increase of E_B as an ohmic drop in R . Since the response of the solenoids S_1 and S_2 is dependent upon a variation of E_L , the lamp voltage cannot be held absolutely constant, but the variation will be small; the use of the solenoid S_1 and pile r increases the sensitiveness of the response of S_2 to a change in E_L . The lamp regulator is used in conjunction with a generator regulator described in Art. 204.

204. Generator Field Regulation.—Fig. 298 illustrates a method of regulating the generator voltage by the variation of a

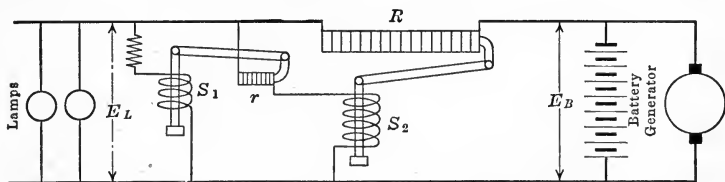

FIG. 297.—Voltage regulation by means of resistance in main line (Gould system).

resistance R in its field circuit. The carbon pile R is acted upon by the two solenoids V and B , the former responding to changes of the generator voltage due to change of speed, and the latter to variations of the battery current. For example, assuming that the contact K is closed and that the generator is charging the battery, any increase of speed will tend to increase both the generator voltage and the charging current. As the charging current increases, the upward pull of solenoid B relieves the pressure normally exerted upon R by the weight of the plunger of B , thus increasing the field resistance of the generator and lowering its voltage. To prevent excessive overcharge of the battery due to high generator speed, the plunger of solenoid V is ar-

ranged so that the increased line voltage causes it to relieve the pressure on the right-hand side of *R*, thereby increasing the field resistance and lowering the generator voltage.

The automatic switch *K* is closed, and the connection between

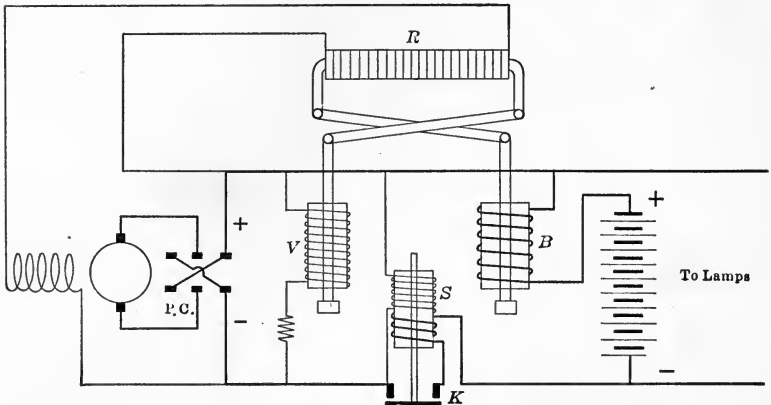

FIG. 298.—Voltage regulation by means of field rheostat (Gould system).

generator and battery is established when the speed of the generator is sufficiently high to generate a voltage capable of actuating the solenoid *S*; the generator current, flowing through the series winding of switch *K*, reinforces the pull of the shunt winding *S*. When the speed falls below this pick-up speed, the battery

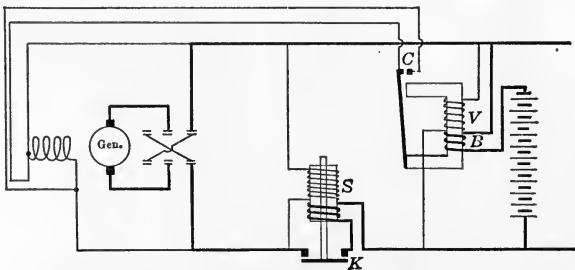

FIG. 299.—Voltage regulation using vibrating contact.

voltage overpowers that of the generator and a reverse current flows through the series winding of *K*, with the result that the net force acting upon the plunger is not sufficient to hold the contacts closed against the gravitational pull. The entire load is

then carried by the battery alone. The pole-changer is represented diagrammatically at *PC*.

Another method, somewhat similar to that of Fig. 298, but involving a vibrating contact analogous to that of the Tirrill regulator, is illustrated in Fig. 299. The automatic switch *K* operates in the same manner as in Fig. 298, but the solenoids *B* and *V* act on the same magnetic circuit and open and close the contact *C*. Thus, if the battery charging current exceeds the safe limit, coil *B* closes contact *C* and momentarily short-circuits the field winding of the generator, thus reducing the generator voltage. Coil *V* operates similarly if the generator voltage rises too high because of high rotative speed.

205. Field and Line Regulation.—Fig. 300 is a diagram of connections of a system of train lighting which, like the system

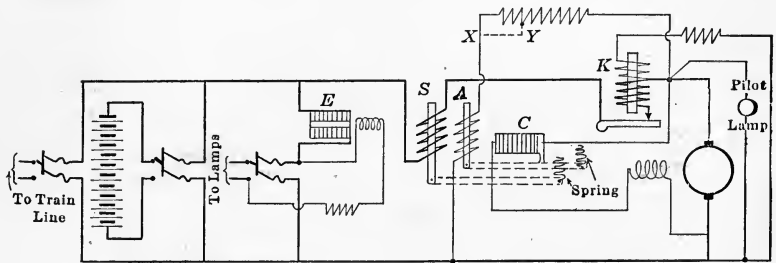

FIG. 300.—Combined field and line regulation (Safety Car Heating & Lighting Co.).

described separately in Articles 203 and 204, includes independent regulation of generator voltage and of lamp voltage.

The resistance of the carbon pile *C*, in series with the shunt field winding of the generator, is controlled by the pressure exerted upon it by levers operated by the plungers of coils *S* and *A*. Coil *S* carries the entire generator current and is adjusted to hold the current at its full rated value. Coil *A*, shunted across the line, is set to hold the generator voltage at 39 volts on equipments having 16-cell lead batteries (2.45 volts per cell); and at 78 volts on "60-volt" equipments having 32 cells of lead batteries. If Edison batteries are used, these voltages are set at 43 volts and 86 volts, respectively, by opening the short-circuit *XY* on part of the resistance in series with the voltage coil *A*. The object of

limiting the generator voltage to 2.45 volts per cell of lead battery is to prevent excessive overcharging of the battery; when the battery is fully charged, the charging current will then automatically taper down to a safe value. The limitation of generator current imposed by coil *S* prevents overloading of the generator due to lamp load or to charging an exhausted battery.

The lamp voltage is controlled by the pair of carbon piles, *E*, in series with the lamps, the two piles being connected in parallel with each other. The pressure upon these piles is due to a system of levers and a toggle joint actuated by a coil connected across the lamp mains. The pull of this electromagnet is opposed by a spring, the design being such that the armature of the electromagnet will remain in any position within the limits of its travel when the lamp voltage is normal.

In this system the armatures of the magnets controlling the generator and the lamp circuit are provided with air dash-pots having graphite plungers. The effect of variation of temperature upon the voltage coils of the generator and lamp regulators is compensated by means of resistors, having zero temperature coefficients, placed in series with these coils.

The automatic switch *K* for establishing the connection between generator and battery at train speeds above the pick-up speed is similar to others already described. The shunt coil lifts the pivoted armature when the generator voltage equals the battery voltage, thus bringing into action the series coil, which assists the shunt coil in holding the switch tightly closed, and which accelerates the opening of the switch when the generator voltage falls below battery voltage.

The four brush arms of the generator are mounted on a rocker ring carried on ball bearings, the ring being free to rotate through 90 degrees between a pair of stops. When the machine is running in one direction, the friction of the brushes against the commutator holds the rocker ring against one of the stops and the brushes are then in the proper position for sparkless commutation. Reversal of the direction of rotation causes the rocker ring to be turned through 90 degrees against the other stop, thus preserving the original polarity of the generator.

Fig. 300*a* shows in diagrammatic form another system which includes a lamp regulator and a generator field regulator, *F*. The

automatic switch K is closed in response to the pull of the voltage coil when the generator speed and voltage have attained their proper values, thereby connecting the battery to the generator. The charging current, flowing through the series coil of the regulator F , tends to be maintained at constant value by the action of the carbon pile rheostat in circuit with the generator field. At the same time the ampere-hour meter, AHM , is running in the direction of charge, and when the battery is charged and the contact needle N has reached its point of contact, the resistance R is short-circuited; thereupon the switch S is energized, contact C is closed, and current flows through the shunt coil of the regulator F . The pull of the shunt coil

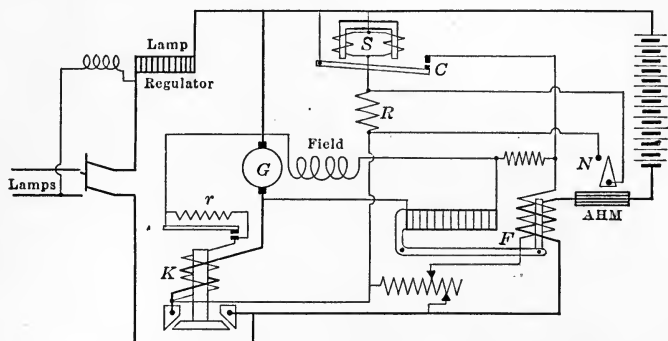

FIG. 300a.—U. S. Lighting and Heating Company system of train lighting.

adds to that of the series coil, so that there results a sudden reduction of generator voltage and the battery is thereby "floated" on the line; that is, the generator supplies current directly to the load and the battery neither charges nor discharges.

206. Regulation by Means of Armature Reaction.—Regulation of generator voltage by making use of armature reaction under load conditions is exemplified in the Rosenberg train lighting generator (Art. 207) and in the automobile lighting generator made by the Wagner Electric Manufacturing Company (Art. 210). This type of regulation, since it is dependent upon the inherent characteristics of the generator, may be classed as electromagnetic.

207. The Rosenberg Train Lighting Generator.—The Rosenberg generator, first described¹ in 1905, embodies a number of interesting structural features and has operating characteristics that make it suitable for train-lighting service. Its distinctive properties are (1) that it develops an e.m.f. the direction of which is independent of the direction of rotation, and (2) that it produces a current which, beyond a certain speed, remains practically constant no matter how much the speed is increased. The diagram of connections of a bipolar machine is shown in Fig. 301, but it will be understood that with suitable modifications the principle is applicable to multipolar machines. The

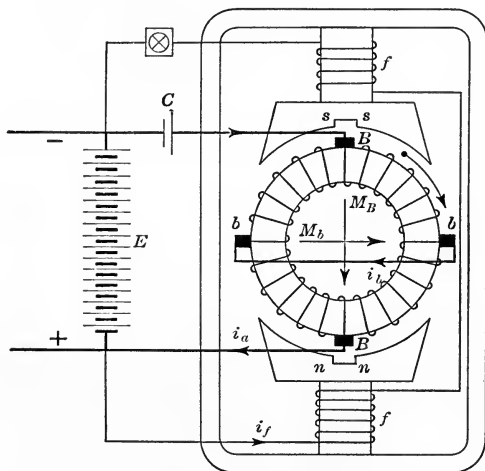

FIG. 301.—Diagram of Rosenberg train-lighting generator.

battery E , which must be used in connection with the generator if the latter is to function properly, supplies current to the lamps when the train is at rest and also to the shunt field winding ff , producing the polarity indicated by nn , ss . The axis of commutation of the brushes BB is in line with the axis of the poles, instead of being at right angles thereto as in the ordinary type of machine.

The brushes BB are connected to the battery terminals through

¹ Elektrotechnische Zeitschrift, 1905, p. 393.

an aluminum cell C which offers a very high resistance to the flow of current from the battery to the armature and only a very small resistance in the direction from the armature to the battery; this property of the aluminum cell prevents the discharge of the battery through the armature when the train is at rest or when running at a speed below that at which the generator picks up its load. In addition to the main brushes there is a pair of short-circuited auxiliary brushes, bb , placed at right angles to the polar axis, that is, in the same position as the main brushes of an ordinary generator.

Rotation of the armature through the magnetic field set up by ff will produce a flow of current through the short-circuited armature along axis bb , thereby creating a powerful cross-field, M_b , the lines of force of this field finding a path of low reluctance through the pole shoes. As is clear from the figure, clockwise rotation will result in a cross-field directed from left to right; the motion of the armature conductors through this cross-field then generates an e.m.f. and current along the BB axis in such a direction that the armature m.m.f., represented by the arrow M_B , opposes the excitation due to the field winding ff . In case the direction of rotation is reversed (that is, becomes counter-clockwise) the direction of the cross-field M_b also reverses, and the effect of this double reversal is to preserve the original polarity of the brushes BB . The fact that the armature m.m.f., M_B , opposes the excitation due to the field winding means that the field flux parallel to the BB axis is small, and this in turn prevents excessive current through the short-circuit bb . The machine differs widely from the ordinary generator in that what is usually the main field is of secondary importance with respect to the cross-field. The weak field in the BB axis obviates commutation difficulties that would otherwise arise due to the short-circuiting of winding elements under the middle of a pole face; such difficulty as might still exist is further overcome by notching the pole faces opposite the main brushes. It is clear that there is a definite limit beyond which the main current delivered by the brushes BB cannot increase, this limit being reached when the armature m.m.f., M_B , neutralizes the field excitation due to ff ; for in that case there would be no e.m.f. and current in the bb axis, hence no e.m.f. in the main brush axis. It follows, there-

fore, that beyond a certain speed the machine will deliver a practically constant current. Any desired limit to the current may be set by adjusting the rheostat in the field circuit ff . The generator may be driven either by a belt from the car axle or by mounting the armature directly on the axle itself.

On the basis of the foregoing qualitative study of the physical phenomena occurring in the machine, Messrs. Kuhlman and Hahnemann¹ have developed the quantitative relations between the speed and current output of the machine operating as a generator. Thus let

n = speed of the armature in r.p.m.

i_f = constant exciting current in field winding ff

i_a = main current output

i_t = short-circuit current in axis bb

$n_f i_f$ = ampere-turns due to ff

$n_a i_a$ = effective ampere-turns of armature in axis BB

$n_b i_b$ = effective ampere-turns of armature in axis bb

E_t = terminal voltage of line, assumed constant

E_b = e.m.f. generated in short-circuit bb

Φ_B = field flux in axis BB

Φ_b = field flux in axis bb

r_a = armature resistance (including brushes)

If saturation of the magnetic circuit is neglected, so that the flux may be considered to be proportional to the m.m.f. that produces it, the following relations will hold

$$E_b = c_1 \Phi_B n \quad (1)$$

$$i_b = \frac{E_b}{r_a} = \frac{c_1}{r_a} \Phi_B n \quad (2)$$

$$\Phi_B = c_2 (n_f i_f - n_a i_a) \quad (3)$$

$$\Phi_b = c_3 n_b i_b \quad (4)$$

$$E_t = c_1 \Phi_b n - i_a r_a \quad (5)$$

Substituting (2) and (3) in (4), there results

$$\Phi_b = c_1 c_2 c_3 \frac{n_b}{r_a} (n_f i_f - n_a i_a) n \quad (6)$$

¹ Elektrotechnische Zeitschrift, Vol. XXVI, 1905, p. 525.

and substituting this value of Φ_b in (5)

$$E_t = c_1^2 c_2 c_3 \frac{n_b}{r_a} (n_f i_f - n_a i_a) n^2 - i_a r_a \quad (7)$$

and

$$i_a = \frac{c_4 n_f i_f n^2 - E_t}{r_a + c_4 n_a n^2} = \frac{\frac{n_f i_f}{n_a} - \frac{E_t}{c_4 n_a n^2}}{1 + \frac{r_a}{c_4 n_a n^2}} \quad (8)$$

where

$$c_4 = c_1^2 c_2 c_3 \frac{n_b}{r_a}$$

From equation (8) the following conclusions may be drawn:

(a) If $n = 0$, $i_a = -\frac{E_t}{r_a}$,

which means, simply, that were it not for the aluminum cell C the armature, at standstill, would be a dead short-circuit on the line (or battery), the negative sign of i_a indicating a flow of current into the armature from the line.

(b) If $n = \infty$, $i_a = \frac{n_f i_f}{n_a}$ or $n_a i_a = n_f i_f$

which means that at infinite speed the armature m.m.f. (M_B) would exactly neutralize the field excitation. This condition therefore determines the limiting current output of the machine running as a generator, or

$$(i_a)_{max} = \frac{n_f i_f}{n_a}$$

This result also shows how the rheostat in the field circuit controls $(i_a)_{max}$ by fixing the value of i_f .

(c) If the machine is to act as a generator, i_a must be positive, hence

$$\frac{n_f i_f}{n_a} = (i_a)_{max} \geq \frac{E_t}{c_4 n_a n^2}$$

or

$$\frac{(i_a)_{max} r_a}{E_t} \geq \frac{r_a}{c_4 n_a n^2}$$

But the term $\frac{(i_a)_{max} r_a}{E_t}$ is the ratio of the maximum ohmic drop in

the armature to the line voltage, and since this ratio must be small from considerations of efficiency, it follows that $\frac{r_a}{c_4 n_a} \cdot \frac{1}{n^2}$ is still smaller in comparison with unity and that with increasing speed it rapidly approaches zero. Therefore the denominator of (8) may be considered equal to unity and the expression for i_a becomes, with only slight error,

$$i_a = (i_a)_{max} - \frac{E_t}{c_4 n_a} \cdot \frac{1}{n^2} \quad (9)$$

Equations (8) and (9) show that the current is zero when

$$n = n_0 = \sqrt{\frac{E_t}{c_4 n_a (i_a)_{max}}} = \sqrt{\frac{E_t}{c_4 n_f i_f}} \quad (10)$$

and that it rapidly approaches $(i_a)_{max}$ as a limit as the speed increases.

For example, suppose that the generator is to supply a maximum current of 50 amperes at a terminal voltage of 50 volts and that it is to pick up its load at a speed of 300 r.p.m. From (10),

$$300 = \sqrt{\frac{50}{c_4 n_a \times 50}}$$

$$c_4 n_a = \frac{1}{90,000}$$

and from (9)

$$i_a = 50 - \frac{4.5 \times 10^6}{n^2}$$

This is the equation of the curve shown in Fig. 302. The manner of variation of i_b , the current in the short-circuited path bb , is determined by combining equations (2), (3) and (9), resulting in the expression

$$i_b = \frac{E_t}{c_1 c_3 n_b} \cdot \frac{1}{n} \quad (11)$$

which represents an equilateral hyperbola. It is seen that i_b is a function of c_3 and this is dependent upon the reluctance in the path of the cross-field Φ_b . The curve showing i_b in Fig. 302 is based on the assumption that $i_b = 60$ amperes when $n = 300$, or $i_b = \frac{18,000}{n}$. The dashed portions of the curves of Fig. 302

computed from equations (9) and (11), correspond to negative values of i_a (indicating motor action), and while not entirely accurate because of the neglect of terms involving r_a in the pres-

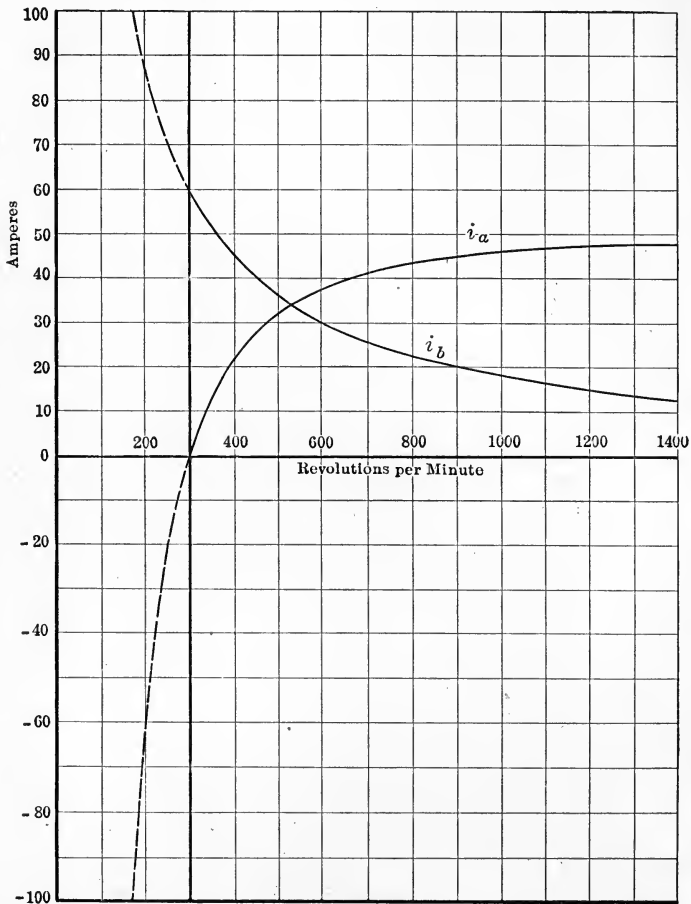

FIG. 302.—Relation between current and speed, Rosenberg generator.

ence of small values of n , they depart only slightly from the correct curves within the range shown in the diagram.

An examination of Fig. 301 will show that in two of the quadrants of the armature winding the currents i_a and i_b flow in the same direction in the conductors, and in the other two quadrants

they flow in opposite directions. The total current in the former case is

$$i_a + i_b = (i_a)_{max} - \frac{E_t}{c_4 n_a} \frac{1}{n^2} + \frac{E_t}{c_1 c_3 n_b} \frac{1}{n}$$

and reaches a maximum value when

$$\frac{d(i_a + i_b)}{dn} = \frac{2E_t}{c_4 n_a} \frac{1}{n^3} - \frac{E_t}{c_1 c_3 n_b} \frac{1}{n^2} = 0$$

or when $n = \frac{2c_1 c_3 n_b}{c_4 n_a}$. Substituting the values used above, the speed corresponding to this maximum current in the conductors is 500 r.p.m., and the currents themselves are $i_a = 32$ and $i_b = 36$.

208. Operation of Rosenberg Machine as a Motor.—The Rosenberg machine when supplied with current from an external

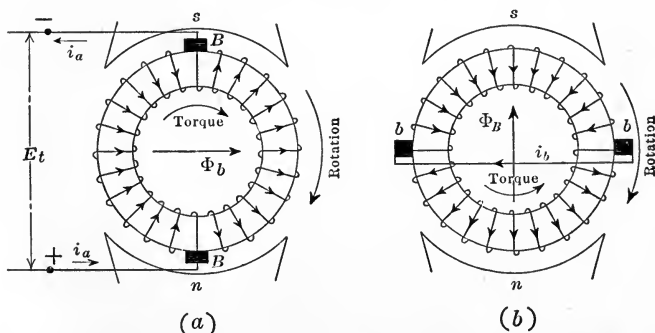

FIG. 303.—Relation between currents and fluxes in Rosenberg machine operating as motor.

source will operate as a motor, but it has no torque at standstill. The reason for this absence of starting torque is clear from Fig. 301, for the armature current and the field flux due to ff have their axes in the same direction and cannot, therefore, react upon each other; and there can be no cross-field to react upon the armature current until rotation through Φ_B produces current and flux in the bb axis. But if the armature is given a start in either direction it will continue to run in that direction. Thus, let Fig. 303 represent the same machine shown in Fig. 301 but taking current from, instead of supplying it to, the line, and let the starting impulse be in the clockwise direction. The figure is drawn in

two parts in order to show with greater clearness the effect of the two pairs of brushes; the arrows on the armature conductors of part (a) show the direction of flow of i_a , and those in (b) serve similarly for i_b . The direction of i_b is determined by applying Fleming's right-hand rule for generator action; had the initial rotation been counter-clockwise, the direction of i_b , and therefore also of Φ_b , would have been opposite to that shown. In either case the reaction between Φ_b and i_a produces a torque in the same direction as the initial rotation and, therefore, serves to accelerate the armature; and the torque due to the reaction between Φ_B and i_b always opposes the rotation. The resultant torque is the difference between these two opposing torques.

Analytically, the characteristics of this motor when supplied from constant potential mains are involved in the equations derived in the preceding article for the case of the generator. All that is necessary is to interpret negative values of i_a in those equations as current input to the motor, but some care should be used in applying equations (9) and (11), especially at low speeds, because the term involving r_a in equation (8) is not then negligible as has been assumed. Thus, if $r_a = 0.10$ ohm, corresponding to a maximum armature drop of 10 per cent. when the constants are those used in the foregoing discussion, the standstill current computed from (9) is $i_a = -\infty$, whereas the true value from (8) is $i_a = -500$. The range of speed through which motor action occurs is from $n = 0$ to $n = \sqrt{\frac{E_t}{c_4 n_f i_f}}$ (0 to 300 r.p.m., Fig. 302). Without going into further particulars it will be clear that the speed characteristic is similar to that of a cumulative compound motor.

209. A modification of the Rosenberg type of generator, together with a special method of voltage control, developed by the Electric Storage Battery Co., is illustrated in Fig. 304. Instead of connecting the shunt field winding across the machine terminals, as in Fig. 301, it is connected between opposite points of a Wheatstone bridge circuit (marked "control bridge" in Fig. 304). There is also a compensating winding, marked "series field," for the purpose of neutralizing the armature reaction due to the main generator current. Two of the bridge arms, marked R , consist of ordinary resistors, while the other two,

marked IR , have negative temperature coefficients. The junction points of the bridge not connected to the control field are connected directly across the line. A variation of generator voltage will then alter the difference of potential between the control field terminals, and the field current will change to a sufficient extent to readjust the generator voltage. If it is desired to give the battery an overcharge, the overcharge switch, which normally short-circuits the resistance R' , is opened, the lamp circuit having been previously disconnected. This has the effect of reducing the voltage impressed on the bridge, in the same manner as though the generator voltage had itself decreased,

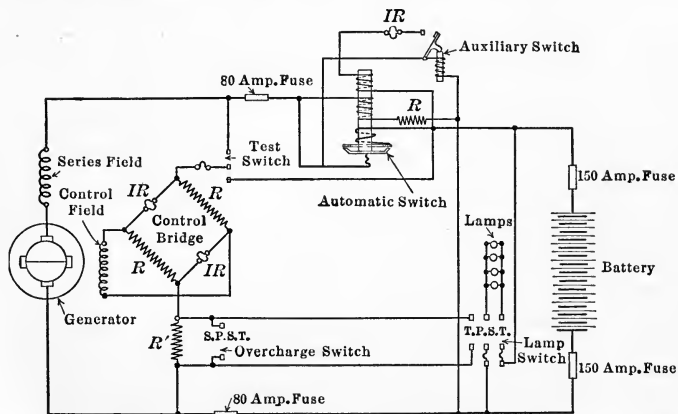

FIG. 304.—Rosenberg generator and control circuits, Electric Storage Battery Co.

hence the readjustment of bridge currents increases the main field excitation and raises the terminal voltage. The extent of the rise of voltage and, therefore, the magnitude of the charging current, is determined by the value of the resistance R' . It will be observed that the closing of the lamp circuit through the triple-pole switch short-circuits R' , thereby reducing the generator voltage to the normal lamp voltage and preventing damage to the lamps because of high voltage during charging. It follows, therefore, that overcharging of the batteries must be accomplished during daylight runs.

The automatic switch, in addition to the usual shunt and series coils, has a third coil connected between the generator and the

battery. The pull due to the main shunt coil is insufficient to close the switch, or to keep it closed without the pull due either to the auxiliary coil or the series coil. The auxiliary coil, therefore, determines the closing of the switch by the difference between the voltages of generator and battery; and the switch will open when the current in the series coil drops to zero.

210. The Wagner Automobile Lighting Generator.¹—The principle of the utilization of armature reaction embodied in the Rosenberg generator is also used in the Wagner automobile lighting generator, though in a quite different manner. The

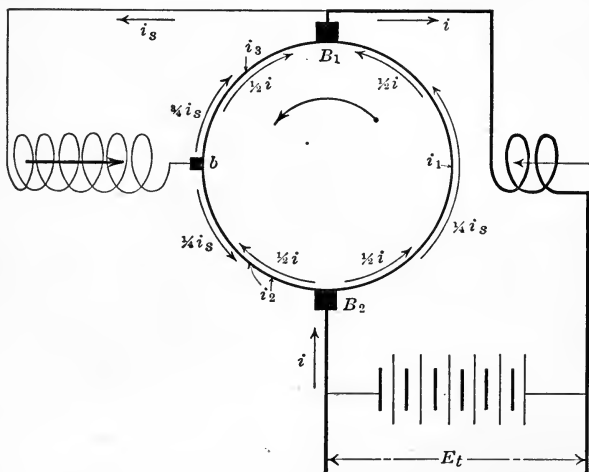

FIG. 305.—Diagram of connections of Wagner automobile lighting generator.

connections of the Wagner machine, Fig. 305 (except for the series field winding, omitted in recent models) are identical with those disclosed in an English patent (No. 9364) issued to W. B. Sayers in 1896. In this machine there is an auxiliary brush b placed midway between the main brushes, and the shunt field winding is connected between this auxiliary brush and one of the main brushes. The Sayers generator, intended for constant speed operation, was driven in such a direction that the portion of the armature winding included between the terminals of the shunt field winding occupied the trailing half of the pole faces; in con-

¹ Langsdorf, Washington University Studies, Vol. II, Pt. I, No. 1, July, 1914.

sequence of armature reaction under load conditions, the total flux under the trailing half of the pole face increased, and the e.m.f. generated in that part of the armature winding included between the terminals of the shunt field winding increased correspondingly, thereby giving rise to a compounding action. But in the Wagner machine the direction of rotation is such that the shunt winding is connected across that part of the armature winding lying under the leading half of the pole face, as shown in Fig. 305, and moreover the machine is intended for variable instead of constant-speed operation, as it is driven directly from the engine of the automobile. The Wagner machine presents a number of features of considerable technical interest; accordingly, there is given below a discussion of the theory of its operation and a derivation of its characteristics.

As originally constructed, the machine had four poles and an armature wound with two distinct two-circuit windings, each provided with its own commutator, the two windings being connected in series. The field winding consisted of shunt and series coils connected differentially, the magnetizing effect of the shunt winding being the greater of the two. The series winding was connected in the main circuit in the usual manner, but the shunt winding, instead of being connected across the main brushes was connected between one of the main brushes (B_1 , Fig. 305) and an auxiliary brush b placed midway between the main brushes and ahead of brush B_1 with respect to the direction of rotation. In other words, the shunt winding tapped that part of the armature winding lying under the leading halves of the poles. The diagram of connections shows the machine reduced to an equivalent two-pole model for the sake of simplicity.

In the form here described, the machine was also used as a series motor for cranking the engine, current for this purpose being taken from the battery. In later models, however, the practice of combining both motor and generator functions in a single unit has been discontinued, and the generator design has been modified by the omission of the series field winding, experience having shown that its effects contributed little or nothing of value. The analytical theory presented below has been worked out on the assumption that the series winding is present, but it is interesting to note that the form of the equations indi-

cates that this winding exerts only minor effects, thus checking with the results of tests.

Referring to Fig. 305, it will be clear that the connections will tend to make the machine regulate for constant current without regard to change of speed, provided the battery voltage remains substantially constant, as is the case when lead batteries are used. For if the machine is delivering current at some given value of speed, an increase of speed will tend to increase both the generated e.m.f. and the current; but the increased current will weaken the field and, therefore, reduce the generated e.m.f.

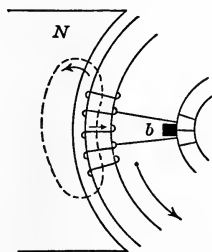

FIG. 306.—Demagnetizing effect due to short-circuited coil.

in two ways: (1) by increasing the magnetomotive force of the decomposing series winding, and (2) by shifting the flux, because of increased cross-magnetizing action of the armature, away from the leading pole tip, thereby reducing the e.m.f. generated in the armature between brushes B_1 and b and consequently weakening the shunt excitation. It is evident that this double demagnetizing effect will ultimately prevent a further increase of current, and it is actually found that beyond a certain

speed the effect of rising speed is to cause the current to fall off from a maximum value. There is a third and most important effect that arises from the fact that the auxiliary brush b short-circuits an element of the armature winding that lies opposite the middle of the pole face and in which there is generated an active e.m.f.; this e.m.f. produces a considerable current in the short-circuited element, and the direction of this current is such that it sets up an additional demagnetizing action in the air-gap under the leading half of the pole face (see Fig. 306).

An examination of the diagram of connections given in Fig. 305 will show that the operation of this machine is not independent of the direction of rotation, for a reversal of the direction of rotation will cause the shunt winding to subtend the trailing half of the poles and radically alter the operating characteristics. This feature is not objectionable in the case of automobile lighting for reasons stated above; but if the machine were to be used for train lighting it would be necessary to add to the equipment

an automatic switch so arranged that a reversal of rotation would simultaneously reverse the terminals of the series winding (if present) and change one of the shunt terminals from brush B_1 to brush B_2 .

ANALYTICAL THEORY

The following symbols recur frequently throughout the analysis and are tabulated below for convenient reference:

- E_t = constant line voltage
- E_a = total e.m.f. generated in the armature
- i = line current
- i_s = shunt field current
- n = speed in r.p.m.
- r_s = resistance of shunt field winding
- r_f = resistance of series field winding
- r_a = armature resistance measured between main brushes and including brush contact resistance
- n_s = shunt field turns per pair of poles
- n_f = series field turns per pair of poles
- Z = number of armature conductors
- Φ = flux per pole
- d = diameter of armature
- l = length of core
- τ = pole-pitch
- δ = air-gap
- ψ = ratio of pole arc to pole-pitch
- p = number of poles
- a = number of parallel paths through armature
- B_g = flux density in air-gap.

It will be clear from the diagram of connections, Fig. 305, that the line current i shown entering brush B_2 can be thought of as dividing equally between the two paths leading to brush B_1 , and that the shunt field current entering brush b may be considered to divide into two parts, $\frac{1}{4}i_s$ and $\frac{3}{4}i_s$, respectively, these two currents being inversely proportional to the resistances of the paths through which they flow. It follows, then, that the currents i_1 , i_2 and i_3 , indicated in Fig. 305, are, respectively,

$$i_1 = \frac{1}{2}i + \frac{1}{4}i_s \tag{12}$$

$$i_2 = \frac{1}{2}i - \frac{1}{4}i_s \tag{13}$$

$$i_3 = \frac{1}{2}i + \frac{3}{4}i_s \tag{14}$$

The main current i flowing through the armature winding produces a cross-magnetizing magnetomotive force distributed linearly over the armature periphery in the manner shown by the sloping line aba' of Fig. 307. Under the pole faces this m.m.f. will produce a transverse field whose intensity at any point may be taken to be proportional to the m.m.f. at that point; but between the poles, because of the high reluctance of the magnetic circuit in that region, the flux will be much less than proportional to the m.m.f., and will have a distribution represented by the saddle-shaped curve. The resulting demagnetizing effect in the leading half of the pole face, between brushes b and B_1 , will then be represented to a sufficient degree of approximation by the cross-hatched area A , Fig. 307. Con-

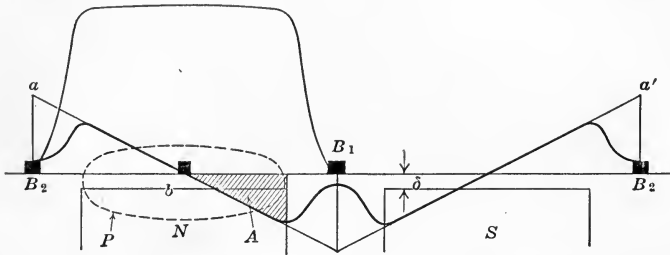

FIG. 307.—Distribution of m.m.f. due to current i .

sidering the closed magnetic circuit indicated by the dashed line P , which is drawn so as to include all of the armature conductors under a pole face, the m.m.f. acting upon this circuit will be $\frac{4\pi}{10} \psi \frac{Z}{2} \cdot \frac{i}{2}$, half of which, or $\frac{4\pi}{10} \psi \frac{Zi}{8}$, will be consumed in the air-gap at each pole tip (assuming that the reluctance of the iron part of the circuit is negligible in comparison with that of the air-gap). If the length of the air-gap, corrected to take account of the effect of the slots, is δ cm., the field intensity at the pole tip will be given by $\frac{4\pi}{10} \psi \frac{Zi}{8\delta}$, and the demagnetizing flux represented by the hatched area A is

$$\phi'_d = \frac{1}{2} \cdot \frac{4\pi}{10} \psi \frac{Zi}{8\delta} \cdot \frac{\psi \tau l}{2} = \frac{4\pi}{10} \frac{\psi^2 \tau l Z}{32 \delta} i \quad (15)$$

The current $\frac{3}{4}i_s$ flowing in the $\frac{Z}{4}$ conductors between brushes b and B_1 results in a peripheral distribution of m.m.f. shown by the trapezoidal-shaped figure of Fig. 308. This fact will be made clear when it is remembered that each conductor in this particular belt of the armature winding has a return conductor in the opposite quadrant, as indicated in Fig. 309, this being a consequence of the fact that the winding has two layers. Under the leading half of the pole face between brushes b and B_1 , the effect

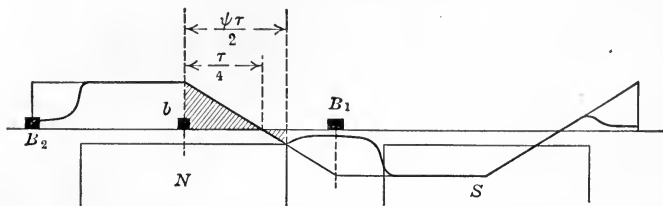

FIG. 308.—Distribution of m.m.f. due to current i_s .

of this current is, on the whole, a magnetizing one. The m.m.f. due to this belt of current at a point opposite brush b is $\frac{1}{2} \frac{4\pi}{10} \frac{Z}{4} \frac{3}{4} i_s$, and the corresponding field intensity at that point is $\frac{4\pi}{10} \frac{3Zi_s}{32\delta}$. The magnetizing flux represented by the hatched area in Fig. 308 is then given by

$$\phi_m = \frac{1}{2} \left[\frac{4\pi}{10} \cdot \frac{3Zi_s}{32\delta} \cdot \frac{\tau}{4} - \frac{4\pi}{10} \frac{3Zi_s}{32\delta} (2\psi - 1)^2 \frac{\tau}{4} \right] l = \frac{4\pi}{10} \frac{3Zi_s\tau l}{256\delta} [1 - (2\psi - 1)^2] \quad (16)$$

Consider now the effect of the current $\frac{1}{4}i_s$ flowing from brush b to brush B_1 by way of the long path through $\frac{3}{4}Z$ conductors. Again bearing in mind that the actual space distribution of this belt of current is as shown in Fig. 310, it will be clear that the currents in the two layers of the first and third quadrants neutralize so far as magnetic effects are concerned, leaving for consideration only those in the second and fourth quadrants. Comparing this distribution with that of Fig. 309, it becomes evident that the distribution of transverse flux due to $\frac{1}{4}i_s$ is identical with that due to $\frac{3}{4}i_s$, but that the total effect is only

one-third as great as that due to the latter. Consequently the total magnetization contributed by the currents $\frac{3}{4}i_s$ and $\frac{1}{4}i_s$ is

$$\phi_m'' = \frac{4}{3} \cdot \frac{4\pi}{10} \frac{3Zi_s\tau l}{256\delta} [1 - (2\psi - 1)^2] = \frac{4\pi}{10} \cdot \frac{Zi_s\tau l}{64\delta} [1 - (2\psi - 1)^2] \quad (17)$$

The net reduction of the flux in the leading half of the pole face is then, so far as armature reaction is concerned, given by the difference between (16) and (17), or it is

$$\phi_d = \frac{4\pi}{10} \frac{Z\tau l}{32\delta} \left[\psi^2 i - \frac{1 - (2\psi - 1)^2}{2} i_s \right] \quad (18)$$

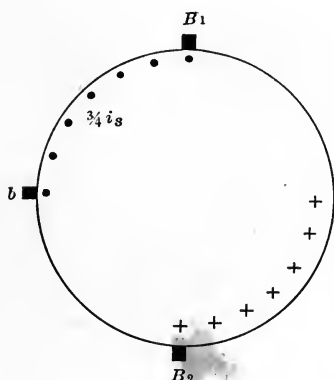

FIG. 309.

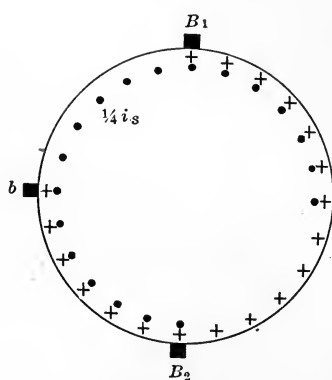

FIG. 310.

FIGS. 309 and 310.—Distribution of components of exciting current.

Taking $\psi = 0.7$, (18) becomes (nearly)

$$\phi_d = \overset{.012}{.02} \frac{Z\tau l}{\delta} (i - 0.86i_s) \quad (19)$$

In addition to the demagnetizing effect caused by the transverse armature reaction, there remains to be considered the effect of the short-circuit current in the armature element under brush b . This brush short-circuits elements that are moving through the strongest part of the field, so that the current set up in them may have considerable magnitude. Since the brush b is opposite the center of the pole face, the field intensity at that point is not appreciably affected by the cross-magnetizing action of the main current i , and not to any great extent by the currents $\frac{3}{4}i_s$ and $\frac{1}{4}i_s$. It may be assumed, therefore, that

the e.m.f. generated in the short-circuited element and, therefore, the short-circuit current as well, is directly proportional to the speed. Since this short-circuit current is always so directed that it produces a demagnetizing effect in the leading half of the pole face, it follows that the total demagnetization in this half of the pole face is given by an expression of the form $(\alpha i - \beta i_s + \gamma n)$, where γ is a constant depending upon the average flux density in the air-gap, the number of turns per armature winding element, and upon the resistance of the element and the brush contact; its value is derived in equation (40). The values of α and β follow immediately from equation (19); but since (19) was derived on the assumption that the machine was a bipolar one, whereas the actual machine is multipolar, it becomes necessary to divide the right-hand member of (19) by the number of pairs of poles in the machine in order that the expression may be perfectly general; therefore,

$$\left. \begin{aligned} \alpha &= \frac{0.4Z\tau l}{\delta p} \\ \beta &= \frac{0.34Z\tau l}{\delta p} \end{aligned} \right\} \quad (20)$$

Since the total flux per pole is Φ , the net flux in the leading half of the pole face is

$$\frac{1}{2}\Phi - \alpha i + \beta i_s - \gamma n$$

The e.m.f. generated in the armature between brushes B_1 and b is then

$$(\frac{1}{2}\Phi - \alpha i + \beta i_s - \gamma n)Z'n$$

where $Z' = \frac{pZ}{a \times 60 \times 10^8}$, p being the number of poles in the machine and a the number of parallel paths through the armature winding. This is the e.m.f. responsible for the production of the shunt field current i_s ; hence

$$i_s = \frac{(\frac{1}{2}\Phi - \alpha i + \beta i_s - \gamma n)Z'n - i_3 r_a}{r_s} \quad (21)$$

Substituting in (21) the value of i_3 from (14) and solving for i_s , there is obtained (noting that $\frac{1}{2}\Phi Z'n = \frac{1}{2}E_a$)

$$i_s = \frac{\frac{1}{2}E_a - i\left(\alpha Z'n + \frac{r_a}{2}\right) - \gamma Z'n^2}{r_s + \frac{3}{4}r_a - \beta Z'n} \quad (22)$$

The useful flux Φ is produced by the differential action of the shunt and series field windings, and if magnetic saturation is neglected, the flux may be taken as proportional to the net excitation; that is,

$$\Phi = c_1(n_s i_s - n_f i) \quad (23)$$

and the total generated e.m.f. is

$$E_a = \Phi Z' n = cn(n_s i_s - n_f i) \quad (24)$$

where

$$c = c_1 Z' \quad (25)$$

Since the total generated e.m.f. must be equal to the sum of the terminal voltage and the ohmic drops in the series field winding and in the armature, there is the further relation that

$$E_a = E_t + i r_f + i_1(2r_a) = E_t + i(r_a + r_f) + \frac{r_a}{2} i_s \quad (26)$$

the final form of (26) being obtained by substituting the value of i_1 from equation (12).

Substituting (22) first in (24) and then in (26), and reducing, there result, respectively,

$$E_a \left(\frac{cn_s n}{2R} - 1 \right) = cni \left[\frac{n_s}{R} \left(\alpha Z' n + \frac{r_a}{2} \right) + n_f \right] + \frac{cn_s \gamma Z'}{R} n^3 \quad (27)$$

and

$$E_a \left(1 - \frac{r_a}{4R} \right) = E_t + i \left[r_a + r_f - \frac{r_a}{2R} \left(\alpha Z' n + \frac{r_a}{2} \right) \right] - \frac{r_a}{2R} \gamma Z' n^2 \quad (28)$$

where

$$R = r_s + \frac{3}{4} r_a - \beta Z' n \quad (29)$$

Dividing (27) by (28) and solving for i , it is found that

$$i = \frac{-cn_s \gamma Z' n^3 + \frac{r_a}{2} \gamma Z' n^2 + E_t \left(\frac{cn_s}{2} + \beta Z' \right) n - E_t (r_s + \frac{3}{4} r_a)}{n^2 (\alpha n_s - \beta n_f) c Z' + n \left[cn_f \left(r_s + \frac{r_a}{2} \right) - \frac{cn_s r_f}{2} - (r_a + r_f) \beta Z' - \frac{r_a}{2} \alpha Z' \right] + (r_a + r_f) (r_s + \frac{3}{4} r_a) - \frac{r_a^2}{4}} \quad (30)$$

Equation (30) represents a curve which shows the relation between the current output i and the speed n . The form of

this curve may be found by noting that i is the quotient of two functions of n , one of which (the numerator) is

$$y_n = -cn_s \gamma Z' n^3 + \frac{r_a}{2} \gamma Z' n^2 + E_t \left(\frac{cn_s}{2} + \beta Z' \right) n - E_t (r_s + \frac{3}{4} r_a) \quad (31)$$

and the other (the denominator) is

$$y_d = n^2 (\alpha n_s - \beta n_f) c Z' + n \left[cn_f \left(r_s + \frac{r_a}{2} \right) - \frac{cn_s r_f}{2} - (r_a + r_f) \beta Z' - \frac{r_a}{2} \alpha Z' \right] + (r_a + r_f) (r_s + \frac{3}{4} r_a) - \frac{r_a^2}{4} \quad (32)$$

The function y_n , since it is a cubic equation, will in general be represented by a curve of the form y'_n or y''_n , Fig. 311, and the

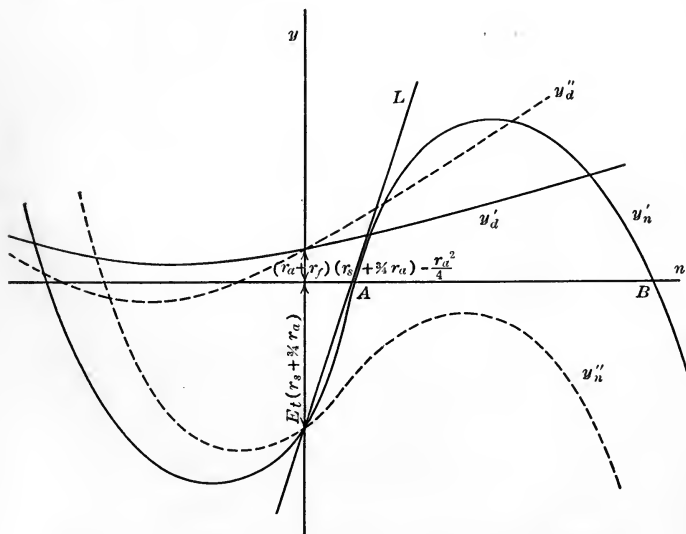

FIG. 311.—Curves representing equations (31) and (32).

function y_d will be represented by a parabola with vertical axis, as shown by the curves y'_d and y''_d , Fig. 311.

The shape of the curve corresponding to (31) will be that of curve y'_n if the three roots of $y_n = 0$ are all real; and will be that of curve y''_n if two of the three roots are imaginary. The curves of Fig. 311 are not drawn to any particular scale, but are merely illustrative of typical forms. But whatever the roots of $y_n = 0$,

the curves will cross the axis of ordinates at a distance below the origin given by $E_t(r_s + \frac{3}{4}r_a)$.

Similarly, the intersections with the axis of n of the parabola represented by (32) can be found by putting $y_d = 0$, in which case

$$n = -\frac{q}{2m} \pm \sqrt{\left(\frac{q}{2m}\right)^2 - \frac{s}{m}} \quad (33)$$

where

$$m = (\alpha n_s - \beta n_f) c Z'$$

$$q = c n_f \left(r_s + \frac{r_a}{2} \right) - \frac{c n_s r_f}{2} - (r_a + r_f) \beta Z' - \frac{r_a}{2} \alpha Z'$$

$$s = (r_a + r_f) \left(r_s + \frac{3}{4} r_a \right) - \frac{r_a^2}{4}$$

The two roots will be real if $q^2 > 4ms$, in which case the parabola will cut the axis of n in two points both of which lie to the left of the origin, as in curve y_d'' , Fig. 311; and the roots will both be imaginary, corresponding to curve y_d' , if $q^2 < 4ms$. It is very easily shown, on inserting the actual values of the constants comprising m , q and s , that the latter condition is the only one that can arise in practice, which means that the parabola representing the function y_d does not intersect the axis of abscissas. In any case, it intersects the axis of ordinates at a distance

$$\left[(r_a + r_f) \left(r_s + \frac{3}{4} r_a \right) - \frac{r_a^2}{4} \right] \text{ above the origin.}$$

The curve showing the relation between i and n can then be obtained by dividing the ordinates of the cubic curve by the corresponding ordinates of the parabola. Obviously, if the machine is to operate satisfactorily as a generator, the curves representing y_n and y_d must be so related that their ordinates will both be positive for a large range of speed (in the positive sense), which means that the function y_n must have three real roots as in curve y_n' , and that point A (Fig. 311) must be as close as possible to the origin and point B as remote as possible. Inspection of equation (31) will suffice to show that the constant γ is the controlling factor in determining the shape of curve y_n' and also the points in which it intersects the axis of n . For suppose that $\gamma = 0$, which would mean physically that there is no demagnetizing effect due to the winding element short-circuited by brush b , or in other words, that there is no current

in this short-circuited element; the numerator of (30) then reduces to

$$y = nE_t \left(\frac{cn_s}{2} + \beta Z' \right) - E_t(r_s + \frac{3}{4}r_a) \quad (34)$$

which represents a straight line shown as *L* in Fig. 311. In this case the curve obtained by dividing the ordinates of the straight line *L* by the corresponding ordinates of the parabola would have the form shown in Fig. 312 within the range of generator action; it is asymptotic to the axis of *n* at infinity. On the other hand, when $\gamma > 0$, the curve showing the relation between *i* and *n* will have the form of Fig. 313. Since in practice γ will always be greater than zero, it is important to investigate this case further, and in particular to determine the condition that will give rise to three real roots of the function $y_n = 0$; for it will readily be seen that if two of the roots are imaginary, as in

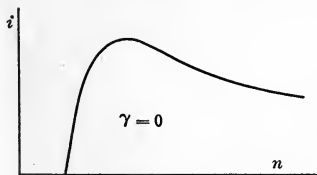

FIG. 312.

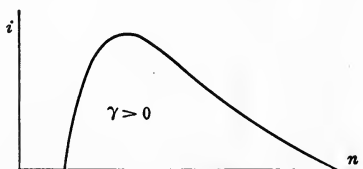

FIG. 313.

FIGS. 312 and 313.—Relation between current output and speed.

curve y''_n , Fig. 311, the current through the machine will be negative for positive values of speed, which would mean that the machine would run as a motor and not as a generator.

Proceeding, then, to the analysis of equation (31), it is easily seen that

$$\begin{aligned} \frac{dy_n}{dn} &= - \left[3cn_s\gamma Z'n^2 - r_a\gamma Z'n - E_t \left(\frac{cn_s}{2} + \beta Z' \right) \right] \\ \frac{d^2y_n}{dn^2} &= - [6cn_s\gamma Z'n - r_a\gamma Z'] \end{aligned}$$

If $\frac{dy_n}{dn}$ is put equal to zero, it is found that the condition which determines the position of the points of maximum and minimum of curves y'_n or y''_n is

$$n = \frac{r_a}{6cn_s} \pm \sqrt{\left(\frac{r_a}{6cn_s} \right)^2 + E_t \left(\frac{cn_s}{2} + \beta Z' \right)} \quad (35)$$

which means that one of these points lies to the right of the origin and the other to the left of the origin. There is a point of inflection in the curve where $\frac{d^2 y_n}{dn^2} = 0$, that is, when $n = \frac{r_a}{6cn_s}$, or midway between the points of maximum and minimum.

To find the condition that the three roots of $y_n = 0$ shall be real, the function can be written

$$n^3 - \frac{r_a}{2cn_s}n^2 - \frac{E_t}{cn_s\gamma Z'}\left(\frac{cn_s}{2} + \beta Z'\right)n + \frac{E_t(r_s + \frac{3}{4}r_a)}{cn_s\gamma Z'} = 0$$

which, on substituting

$$n = x + \frac{r_a}{6cn_s} \tag{36}$$

becomes

$$x^3 - \left[\frac{E_t}{\gamma} \left(\frac{1}{2Z'} + \frac{\beta}{cn_s} \right) + \frac{r_a^2}{12c^2n_s^2} \right] x + \frac{E_t}{cn_s\gamma} \left[\frac{r_s + \frac{3}{4}r_a}{Z'} - \frac{r_a}{6} \left(\frac{1}{2Z'} + \frac{\beta}{cn_s} \right) \right] - \frac{r_a^3}{108c^3n_s^3} = 0 \tag{37}$$

This equation is of the form

$$x^3 - \xi x + \eta = 0$$

which will have three real roots if the absolute value of $\frac{\xi^3}{27}$ is greater than $\frac{\eta^2}{4}$. In this particular case

$$\left. \begin{aligned} \xi &= \frac{E_t}{\gamma} \left(\frac{1}{2Z'} + \frac{\beta}{cn_s} \right) + \frac{r_a^2}{12c^2n_s^2} \\ \text{and} \\ \eta &= \frac{E_t}{cn_s\gamma} \left[\frac{r_s + \frac{3}{4}r_a}{Z'} - \frac{r_a}{6} \left(\frac{1}{2Z'} + \frac{\beta}{cn_s} \right) \right] - \frac{r_a^3}{108c^3n_s^3} \end{aligned} \right\} \tag{38}$$

To reduce the values of ξ and η to simpler and more manageable form, it is necessary to evaluate the characteristic constants that enter into their expressions. Thus, from (23)

$$c_1 = \frac{\text{flux per pole}}{\text{amp-turns per pair of poles}} = \frac{B_p \psi \tau l}{k \times 1.6 B_g \delta} = \frac{\psi \tau l}{1.6 k \delta}$$

where k is the ratio of the excitation required for the complete magnetic circuit to that required by the double air-gap. Unless extremely high flux densities are used, k will be somewhere be-

tween 1.2 and 1.4, with an average value of about 1.25. It follows from (25) that

$$c = c_1 Z' = \frac{\psi \tau l}{1.6k\delta} \cdot \frac{pZ}{a \times 60 \times 10^8} \tag{39}$$

The magnitude of the constant γ is determined by the consideration that the demagnetizing flux ϕ caused by the current in the element short-circuited by brush b is given by γn , or $\gamma = \frac{\phi}{n}$. If the e.m.f. in the short-circuited element is $e_{s.c.}$, the average current in the element will be $i_{s.c.} = \frac{e_{s.c.}}{r}$, where r is the apparent resistance of the short-circuit, and

$$\phi = \frac{\frac{4\pi}{10} \frac{Z}{2S} i_{s.c.}}{2\delta} = \frac{4\pi}{10} \frac{Z}{2S} \frac{\psi \tau l}{4\delta} \frac{e_{s.c.}}{r}$$

$$\cdot \frac{1}{\frac{1}{2}\psi \tau l}$$

where S is the number of commutator segments. In practice, $\frac{Z}{2S} = 1$, as a general rule. But $e_{s.c.}$ is given by¹

$$e_{s.c.} = B_g l \frac{\pi d n}{60 \times 10^8} \frac{Z}{S} \times \frac{p}{2}$$

hence

$$\gamma = \frac{\phi}{n} = \frac{\pi \psi}{2400 \times 10^8} \left(\frac{Z}{S}\right)^2 \frac{\tau^2 l^2 B_g p^2}{\delta r} \tag{40}$$

Substituting these values of c and γ in (38), it will be found that terms involving r_a^2 and r_a^3 are negligibly small in comparison with the others. Dropping r_a in comparison with r_s , the values of ξ and η become

$$\left. \begin{aligned} \xi &= \frac{12 \times 10^{10} E_t \delta r}{\pi \psi p^2 Z' B_g \tau^2 l^2} \left(\frac{S}{Z}\right)^2 \left(\frac{1 + 1.09 kZ}{\psi p n_s}\right) \\ \eta &= \frac{38.4k \times 10^{10} E_t r_s \delta^2 r}{\pi \psi^2 \tau^3 l^3 (Z')^2 n_s B_g p^2} \left(\frac{S}{Z}\right)^2 \end{aligned} \right\} \tag{41}$$

Substituting these values in the criterion

$$\frac{\xi^3}{27} > \frac{\eta^2}{4}$$

¹ The factor $\frac{p}{2}$ arises from the fact that in a series winding a single brush short-circuits $\frac{p}{2}$ elements in series.

and reducing, it follows that

$$r > \frac{10.85 k^2}{\psi} \frac{r_s^2 \delta B_a a p}{n_s^2 E_t Z \left(1 + \frac{1.09 kZ}{\psi p n_s}\right)^3} \left(\frac{Z}{S}\right)^2 \tag{42}$$

The physical meaning of the last result is that unless the resistance of the short-circuited element, including brush contact resistance, is greater than a definite limit, the demagnetizing effect of the short-circuit current will so far weaken the field at the leading pole tip as to prevent the machine from building up; that is, an extremely small value of r would result in the machine taking current from the line, or running as a motor at all positive values of speed. In practice, the contact resistance between the carbon brush b and the commutator will be sufficiently high to insure that r will exceed the critical value, which means that the characteristic curve of Fig. 313 will always cut the axis of n in two points lying to the right of the origin and in one point to the left of the origin; the latter point has no practical significance, since it relates to the condition of running backward. The three points of intersection with the axis of n can be located by finding the three roots of (37) and then substituting for x its value from (36). Since the coefficients of (37) are necessarily so related that $\frac{\xi^3}{27} > \frac{\eta^2}{4}$, equation (37) is the irreducible case of Cardan's rule, and the solution must be found by trigonometric methods. The three roots of (37) are¹

$$\left. \begin{aligned} x_1 &= 2\sqrt{\frac{\xi}{3}} \sin \frac{1}{3}\theta \\ x_2 &= 2\sqrt{\frac{\xi}{3}} \sin (60 - \frac{1}{3}\theta) \\ x_3 &= -2\sqrt{\frac{\xi}{3}} \sin (60 + \frac{1}{3}\theta) \end{aligned} \right\} \tag{43}$$

where

$$\sin \theta = \frac{\frac{\eta}{2}}{\sqrt{\frac{\xi^3}{27}}}$$

¹ Chauvenet's Plane and Spherical Trigonometry, pp. 99-100.

hence the abscissas of the three points of intersection of the curve of Fig. 313 (only two of them are shown) are

$$\left. \begin{aligned} n_1 &= \frac{r_a}{6cn_s} + 2\sqrt{\frac{\xi}{3}} \sin \frac{1}{3}\theta \\ n_2 &= \frac{r_a}{6cn_s} + 2\sqrt{\frac{\xi}{3}} \sin (60 - \frac{1}{3}\theta) \\ n_3 &= \frac{r_a}{6cn_s} - 2\sqrt{\frac{\xi}{3}} \sin (60 + \frac{1}{3}\theta) \end{aligned} \right\} \quad (44)$$

Substituting the values of ξ and η from (41) in the expression for $\sin \theta$ given in equation (43),

$$\sin \theta = \frac{3.28k}{\sqrt{\psi}} \frac{Z}{S} \frac{r_s}{n_s} \sqrt{\frac{a\delta B_a p}{E_i Z r \left(1 + \frac{1.09kZ}{\psi p n_s}\right)^3}} \quad (45)$$

It has been previously pointed out that satisfactory operation of the generator requires that the points *A* and *B* of Fig. 311 shall be separated as widely as possible; and it is also important that point *A* (corresponding to the speed n_1) shall be as close to the origin as possible in order to secure the advantage of a low pick-up speed. It follows, therefore, that $\sin \frac{1}{3}\theta$, and therefore also $\sin \theta$, shall be small. Inspection of equation (45) shows that the conditions to be satisfied to meet this requirement are as follows:

1. Make the resistance r as large as possible, that is, make the brush b of hard carbon with the smallest practicable dimensions. The desirability of this design is involved in the discussion of Fig. 312.

2. Design the armature winding with one turn per element ($\frac{Z}{S} = 2$).

3. Design the shunt field winding so as to have a low resistance per turn ($\frac{r_s}{n_s}$ small).

4. Use a simple two-circuit armature winding ($a = 2$).

5. Make the air-gap as small as possible.

6. Select a moderate value of flux density in the air-gap and make Z correspondingly large. In other words, the armature should be magnetically powerful.

It is interesting to note that for moderate speeds the cubic curve y'_n of Fig. 311 does not deviate greatly from the straight line L . For the slope of the line L , as determined by (34), has the constant value $E_t \left(\frac{cn_s}{2} + \beta Z' \right)$, and that of the cubic curve is given by

$$\frac{dy_n}{dn} = E_t \left(\frac{cn_s}{2} + \beta Z' \right) - \gamma Z' (3cn_s n^2 - r_a n),$$

hence, when the speed n is low, as in the vicinity of the pick-up speed, these two slopes will not differ greatly, and will approach equality as γ approaches zero. This fact may be used to determine approximately the condition that will give rise to the maximum current output of the machine. It is possible, of course, to determine this condition accurately by differentiating equation (30) with respect to n and equating the resulting expression to zero; but this procedure develops excessive complications for the reason that the differentiation gives an equation of the fourth degree in n . If, therefore, equation (30) is simplified by dropping terms containing γ , the approximate expression for i becomes

$$i = \frac{E_t \left(\frac{cn_s}{2} + \beta Z' \right) n - E_t (r_s + \frac{3}{4} r_a)}{mn^2 + qn + s} \quad (46)$$

Putting in the condition that $\frac{di}{dn} = 0$, it is found that

$$n = \frac{r_s + \frac{3}{4} r_a}{\frac{cn_s}{2} + \beta Z'} \pm \sqrt{\left(\frac{r_s + \frac{3}{4} r_a}{\frac{cn_s}{2} + \beta Z'} \right)^2 + \frac{s}{m} + \frac{q}{m} \left(\frac{r_s + \frac{3}{4} r_a}{\frac{cn_s}{2} + \beta Z'} \right)} \quad (47)$$

Inspection of (46) will show that

$$n = \frac{r_s + \frac{3}{4} r_a}{\frac{cn_s}{2} + \beta Z'}$$

is the approximate value of the pick-up speed of the machine. Furthermore, the constants q and s are very small compared with m , so that the terms $\frac{q}{m}$ and $\frac{s}{m}$ in (47) are negligible. It follows, therefore, that the maximum current output will occur

at a speed somewhat greater than twice the pick-up speed; this conclusion is checked by test results.

It has been previously pointed out that experience has shown that the series field winding can be omitted without materially affecting the operation of the machine. The analytical reason for this fact is clear from the form of equation (30). It will be observed that the factors r_f and n_f , respectively the resistance and the number of turns per pair of poles of the series winding, appear only in the denominator, that is, in equation (32), which is represented graphically by the parabola of Fig. 311; since

$$\frac{dy_a}{dn} = 2n(\alpha n_s - \beta n_f)cZ' + \left[cn_f \left(r_s + \frac{r_a}{2} \right) - \frac{cn_s r_f}{2} - (r_a + r_f)\beta Z' - \frac{r_a}{2} \alpha Z' \right]$$

it is clear that within the working range of speed (to the right of the origin), the principal effect of r_f and n_f is to alter the slope of the parabola, but only to a small extent since in any case their numerical values are relatively small.

INDEX

(Numbers refer to pages)

A

Abampere, definition of 11, 17
 Abcoulomb, definition of 12
 Abvolt, definition of 12
 Acceleration of trains 227
 Acyclic generator 72
 Air ducts, armature 63
 -gap, area 120
 ampere-turns 119, 120
 chamfering required by 142
 flux density 65
 distribution
 145, 147, 152, 155
 fringing correction 121
 All-day efficiency 325
 Alternating-current machines 44
 e.m.f. rectification 52
 Alternator 44
 generated e.m.f. 46, 50
 Altitude, effect on temperature
 rise 329
 Ambient temperature 328
 Ampere, definition of 15
 Ampere-conductors 146
 Ampere-turns 25
 air-gap 119, 120
 armature core 128
 armature, per pole 142
 cross-magnetizing 138, 141
 demagnetizing 138, 141
 field, per pole 142
 interpole 300
 pole cores and shoes 128
 teeth 124
 yoke 129
 Armature 44
 amp-turns per pole 142

Armature, characteristic 167
 circuits, number of 98
 coils 105, 268, 295, 300
 conductors, number of 96
 core construction 62
 excitation 128
 disk 63, 89
 drum 88
 eddy currents 62
 e.m.f. generated in 56
 field, shape of 145
 flux 283
 heating 340
 magnetizing action of 133
 reaction 133, 137, 205, 286
 regulation by 361, 366
 resistance 57, 305
 ring 88
 winding—see Winding
 Automobile lighting generator
 366, 376
 Axis, of commutation 137, 241
 geometrical neutral 133
 neutral 134
 Axle lighting system 359

B

Back ampere-turns 138, 141
 e.m.f. 199
 Balancer 191, 358
 Battery ampere-hour capacity
 350, 351
 discharge rate 350, 351
 end cells 350
 train equipment 360
 voltage range 349, 351
 Bearing friction 314

- Bijur system, booster control... 357
 Biot-Savart, law of..... 10
 Bipolar machines..... 59
 · cross-magnetizing amp-
 turns..... 138
 demagnetizing amp-turns. 138
 Booster..... 347
 auxiliary control..... 354
 Bijur system of control... 357
 constant current..... 350
 differential..... 353
 Entz control system..... 355
 Hubbard control system... 354
 motor capacity for shunt.. 350
 negative..... 348
 non-reversible..... 350
 reversible..... 353
 series..... 347
 shunt..... 348
 track return..... 348
 Bridge control..... 231
 Brushes..... 66, 292
 current density
 67, 249, 254, 293
 contact resistance.... 240, 247
 drop of potential at
 163, 293, 306, 323
 friction loss..... 315
 holders..... 66
 lead..... 137
 pressure..... 67
 sets required..... 93
 wide, effect of..... 264
 width..... 294
 Building up of generators
 75, 76, 83, 171
- C
- Capacity of machines..... 326
 Carter correction factor..... 122
 criterion for commutation. 267
 Characteristics..... 161
 armature..... 168
 compound generator..... 181
 motor..... 211
 load..... 166
 Characteristics, no-load, 113, 115, 116
 Rosenberg machine.... 369, 373
 separately excited genera-
 tor..... 162
 motor..... 204
 series generator..... 168
 motor..... 209
 shunt generator..... 173
 motor..... 208
 Chord windings..... 101, 262, 293
 demagnetizing effect of... 143
 Coefficient of coupling..... 37
 dispersion or leakage.. 117, 129
 mutual-induction..... 36, 273
 output..... 335
 self-induction, 33, 268, 295, 300
 Coil, armature..... 105
 dummy..... 102
 mutual inductance of... 273
 numbering of..... 100
 order of commutation. 259
 self-inductance, 268, 295, 300
 field..... 79
 heating of..... 343
 field intensity on axis of... 16
 magnetic potential due to 19, 20
 Commutating devices..... 290
 e.m.f. 242, 244, 246, 249, 276, 293
 field..... 142, 280, 295, 297
 poles, 71, 279, 297, 298, 300, 301
 Commutation..... 135, 237
 adjacent coils..... 256, 264
 axis of..... 137, 241
 criterion..... 246, 267
 improvement of..... 286
 linear..... 238, 243, 248
 over-..... 238, 243, 246, 262
 period of..... 237, 263
 resistance..... 240
 selective, in wave windings, 263
 sinusoidal..... 238, 248
 successive phases..... 259
 under-..... 239, 243, 256
 voltage..... 240
 without auxiliary devices.. 292
 Commutator blackening..... 262
 construction..... 60, 71

- Commutator diameter..... 61
friction loss..... 315
heating..... 61, 329, 334, 345
peripheral velocity..... 62
pitch..... 97
segments, current density . 250
number of..... 96
voltage between..... 61, 295
- Compensating devices..... 287
- Compensation of armature reac-
tion..... 286
- Compound excitation..... 77
generator characteristics... 181
generators in parallel..... 188
motor characteristics..... 211
- Compounding effect of inter-
poles..... 301
- Conductors, number of arma-
ture 96
- Constant current booster..... 350
regulation..... 171
- Contact resistance of brushes 240, 247
- Contactors..... 233
- Continuous current..... 45
rating of motors..... 326, 332
- Control of boosters..... 354
bridge..... 231
series-parallel..... 227
shunt motor speed..... 217
- Controllers..... 229
- Cooling curves..... 336
- Core, armature..... 62
ampere-turns for..... 128
corrected length..... 123
heating of..... 339
losses, 304, 306, 314, 315, 345
pole..... 65, 296
ampere-turns for..... 128, 300
- Coulomb, law of..... 3
- Counter e.m.f..... 199, 214
- Coupling, coefficient of..... 37
- Criterion, sparking..... 246, 267
- Cross-field..... 368
magnetizing action of
137, 378, 380
demagnetizing compo-
nent..... 148
- Cross-field, magnetizing ampere-
turns..... 138, 141
- Cumulative compound motor.. 211
- Current, absolute unit of.... 11, 17
continuous..... 45
density in brushes
67, 249, 254, 293
at commutator segment 250
direct..... 44
direction of force due to... 12
eddy or Foucault..... 62
force due to..... 10
heating due to..... 15
induced..... 8
practical unit of..... 15
short-circuit.... 238, 282, 382
- D
- Demagnetizing action, 137, 378, 382
ampere-turns..... 138, 141
corrected..... 143
component of cross-mag-
netization..... 148
- Deri winding..... 289
- Diamagnetic substances..... 1, 25
- Difference of potential, elec-
trical..... 12
magnetic..... 7
- Differential booster..... 353
compound motor..... 211
motors, starting of..... 215
- Direct current..... 44
machine..... 44
- Discharge rate of battery..... 350
- Disk armature..... 63, 89
- Dispersion, coefficient of... 117, 129
- Distribution of flux in air-gap
147, 152, 155
- Division of load, generators... 188
motors..... 235
- Drum windings..... 89, 107
- Dummy coils..... 102
- Duration of short-circuit . 237, 263
- Dynamo..... 43
construction of..... 58
bipolar and multipolar... 59

- Dynamo, field excitation..... 73
 Dynamotor..... 68
- E**
- Eddy currents, armature core . 62
 pole faces..... 66
 loss, armature conductors 351
 core.....309, 311
 pole faces..... 313
 teeth..... 312
- Efficiency.....304, 317
 all-day..... 325
 commercial or true..... 317
 of conversion..... 317
 electrical..... 318
 maximum.....321, 324
 mechanical..... 318
 variation with load..... 321
- Electric Power Club..... 334
- Electric Storage Battery Co.,
 system of train
 lighting..... 374
- Electrical potential.....9, 12
 regulation of voltage, train
 lighting..... 361
- Electricity, quantity of..... 11
- Electrolysis..... 348
- Electromagnetic induction..... 8
 Faraday's law of..... 13
- Electromagnets, tractive effort
 of..... 38
- Electromotive force..... 8
 of alternator.....46, 50
 commutating
 242, 244, 246, 249, 276, 293
 of direct current generator, 56
 counter.....199, 214
 direction of induced..... 9
 generated and induced.... 48
 magnitude of induced..... 12
 of mutual-induction..... 34
 rectification of alternating 52
 of self-induction..... 33
 pulsations of.....52, 55
 unit of.....12, 15
- Element of winding..... 90
- Elements, number of..... 96
- End cells..... 350
 connections, form of..... 105
 heating..... 343
 leakage flux.....268, 271
- Energy stored in magnetic field, 37
- Entz system of booster control, 355
- Equalizer..... 187
- Equipotential connections..... 107
 lines and surfaces..... 8
- Excitation of dynamos—see
 Field Excitation.
- F**
- Faraday's law of electromag-
 netic induction.....8, 13
- Feeders, negative..... 348
- Field, air-gap distribution of
 147, 152, 155
 ampere-turns per pole.... 142
 armature, shape of..... 145
 coil heating..... 343
 commutating, 142, 280, 295, 297
 control of speed..... 219
 cross-..... 368
 displacement of windings, 98
 dynamo..... 44
 energy of magnetic..... 37
 excitation.....73, 149
 fringing..... 297
 heating of coils..... 343
 intensity..... 3
 due to circular coil..... 16
 solenoid..... 17
 straight wire..... 11
 at pole tips..... 141
 magnetic..... 1
 pulsations..... 280
 reaction of short-circuit
 currents upon....115, 282
 regulation, train lighting
 362, 364
 reversal of commutating
 142, 295
 rheostats..... 81
 step of windings..... 100

Field windings.....	75, 76, 79, 343	Generator, turbo.....	70
Fleming's left-hand rule.....	12	Wagner automobile light-	
right-hand rule.....	9, 32	ing.....	366, 376
Flux.....	4	Gilbert, definition.....	21
density.....	24	Gould system of train lighting..	362
air-gap.....	65	Gravitational potential.....	8
pole cores.....	65		
teeth.....	297		
distribution, air-gap			
145, 147, 152, 155,	283		
leakage.....	117, 129	Head-end system, train lighting,	359
end-connection.....	268, 271	Heat, mechanical equivalent of,	16
slot.....	268	Heating of armature.....	328, 340
tooth-tip.....	268, 270	commutator, 328, 329, 333, 345	
linkages.....	20	curves.....	336
from magnet pole.....	5	due to current.....	15
Force, magnetic, due to current.	10	of end-connections.....	343
direction of, due to current.	12	of field coils.....	343
Foucault currents—see Eddy		of railway motors.....	332
Currents		Heat run.....	326
Fractional pitch windings		Henry, definition.....	33
101, 262, 293		Homopolar generator.....	72
demagnetizing effect of....	143	Hottest-spot temperatures....	328
Friction loss.....	314, 320	Hubbard system of booster	
Fringing of flux.....	121, 123	control.....	354
Froelich's equation.....	179	Hysteresis.....	116
		loss.....	306

G

Gauss, definition.....	3
Generated e.m.f.....	48
Generator.....	43
acyclic, homopolar or uni-	
polar.....	72
building up...75, 76, 83,	171
combined output.....	185
compound, characteristics.	181
division of load.....	188
Lundell.....	297
parallel operation.....	186
polarity.....	83
Rosenberg.....	366, 374
separately excited.....	162
series.....	75, 168
shunt.....	173
stability of operation.....	170
three-wire.....	191

I

Imbedded-detectors.....	331
Induced current.....	8
e.m.f.....	8, 12, 48
Inductance of armature coils —	
see Self-induction	
Induction, electromagnetic....	8
lines of.....	24
magnetization by.....	2
Insulation, classes of.....	328
temperature limits....	328, 332
Intensity, field.....	3
axis of coil.....	16
solenoid.....	17
of magnetization.....	39
Interpole machines.....	71
motors.....	220
Interpoles.....	71, 279, 297, 300
Iron loss.....	304

- Iron loss, eddy currents,
 306, 308, 312, 313
 hysteresis..... 306, 308
 total..... 314
- J
- Joule, definition of..... 15
- K
- Kirchhoff's laws, 30, 108, 244, 263
- L
- Lap winding, 91, 100, 143, 257, 263
 Laplace, law of..... 10
 Lead of brushes..... 137
 Leakage, magnetic..... 117
 coefficient of..... 117, 129
 flux, end-connections.. 268, 271
 pole cores..... 13
 shoes..... 130
 slots..... 268
 tooth-tip..... 268, 270
 Left-hand rule, Fleming's..... 12
 Lenz's law..... 14, 32
 Lighting of trains..... 359
 Lincoln adjustable speed motor. 221
 Linear commutation, 238, 243, 248
 Lines of induction..... 24
 equipotential..... 8
 force..... 3
 Linkages, number of flux..... 20
 Load characteristic..... 166
 curve..... 325
 Losses..... 304
 core or iron, armature
 306, 309, 320
 pole face..... 313
 teeth..... 308, 312
 total..... 314, 345
 copper, armature..... 305
 commutator..... 306
 field..... 305
 mechanical..... 314, 320
 miscellaneous..... 315
 stray power..... 317, 318
 summary of..... 317
- Loss line..... 165
 Lundell generator..... 297
- M
- Magnetic circuit, law of..... 26
 examples of application... 27
 field..... 1
 distribution, air-gap... 145
 uniform..... 4
 flux..... 4
 force, lines and tubes of... 3
 due to current..... 10
 direction of..... 12
 leakage..... 117, 129
 potential..... 6
 of coils..... 19, 20
 reluctance..... 26
 Magnetism, residual..... 75, 83
 Magnetization curves..... 24
 of dynamos... 113, 115, 116
 by induction..... 2
 intensity of..... 39
 Magnetizing action of armature 133
 Magnetomotive force..... 21
 Magnet pole, unit..... 2
 flux from..... 5
 Maximum efficiency..... 322, 324
 Maxwell, definition of..... 4
 Mechanical characteristics,
 motors..... 199
 equivalent of heat..... 16
 losses..... 304, 314, 315, 320
 regulation of voltage..... 361
 Miscellaneous losses, 304, 315, 316
 Motor..... 43, 199
 capacity, shunt booster... 350
 compound, characteristics. 211
 counter e.m.f..... 199, 214
 direction of rotation..... 85
 division of load..... 235
 enclosed, rating of..... 345
 interpole..... 220
 power of..... 199
 railway..... 224
 heating of..... 332
 reversing..... 214

- Motor, Rosenberg..... 373
 separately excited..... 204
 series..... 209
 shunt..... 208
 speed regulation, shunt.... 217
 pulsation, interpole.... 303
 starting of..... 202
 differential compound... 215
 torque..... 199
 Motor-generator..... 68
 Multiplex windings..... 94
 Multipolar machines..... 45, 59
 cross- and demagnetizing
 effect..... 139
 Multi-voltage speed control... 218
 Mutual inductance, armature
 coil..... 273
 induction..... 34
 coefficient of..... 36
- N
- Negative booster..... 348
 feeder..... 348
 Neutral axis..... 134
 geometrical..... 133
 Non-reversible booster..... 350
- O
- Oersted, definition..... 26
 discovery of..... 10
 Ohmic losses..... 304
 armature..... 305
 commutator..... 306
 field..... 305
 Output coefficient..... 335
 equation..... 334
 Overcommutation, 238, 243, 246, 262
- P
- Parallel distribution..... 159
 operation of generators... 186
 windings..... 92, 100
 Paramagnetic substances..... 1, 25
 Period of commutation..... 237, 263
 Peripheral velocity of armature,
 effect on temperature rise. 341
 Permeability..... 23
 Permeance..... 27
 Pig-tail connectors..... 68
 Pitch of windings..... 97
 Polarity of generators..... 83
 Pole arc, corrected length..... 121
 changer..... 361, 364
 commutating
 71, 279, 297, 298, 300
 cores, ampere-turns for... 128
 construction of..... 65, 296
 flux density in..... 65
 leakage..... 131
 shoes, ampere-turns for... 128
 construction..... 65
 eddy current loss..... 66, 313
 leakage flux..... 130
 saturation..... 296
 unit magnet..... 2, 5
 Poles, choice of number of.... 59
 Potential curve..... 154
 electrical..... 9, 12
 energy..... 6
 gravitational..... 8
 magnetic..... 6, 19, 20
 Power of motors..... 199
 Pulsations, commutating field.. 280
 e.m.f., magnitude of..... 55
 speed, interpole motors.... 303
- Q
- Quantity of electricity, unit... 11
- R
- Railway controllers..... 229
 motors..... 224
 cycle of operations..... 225
 heating..... 332
 rating..... 226, 332
 stand-test..... 332
 Rating..... 326
 continuous and short-time 326
 enclosed motors..... 345

- Rating, railway motors... 226, 332
 Reactance voltage, 247, 248, 279, 293
 Reaction, armature... 133, 205
 compensation of... 286
 components of... 137
 regulation of voltage by, 361, 366
 of short-circuit currents, 115, 282
 Rectification of alternating
 e.m.f.... 52
 Reentrancy, degree of... 94, 103
 Regulation, definition... 161
 by armature reaction... 361, 366
 for constant current... 171
 curve... 168
 field... 362, 364
 resistance, train lighting... 362
 speed, shunt motors... 217
 voltage, train lighting... 360
 Regulator, lamp... 362, 364
 Tirill... 195
 Reluctance... 26
 Resistance, armature winding
 57, 305
 brush contact... 240, 247
 commutation... 240
 field, effect on speed... 178
 measurement of temperature rise by... 331
 regulation, train lighting
 362, 364
 Reversible booster... 353
 Rheostat, field... 81
 discharge... 83
 motor starting... 203
 Rheostatic control of speed... 217
 Right-hand rule, Fleming's... 9
 Ring winding... 89, 91, 241, 256
 Rocker ring... 66
 Rosenberg generator... 366, 374
 machine as motor... 373
 Rotation of motors, direction
 of... 85
- S
- Safety Car Heating & Lighting
 system of train lighting... 364
 Saturation of pole tips... 296
 teeth... 297
 Sayers' winding... 290
 generator... 376
 Segments of commutator, number... 96
 average voltage between, 61, 295
 current density... 250
 Selective commutation... 263
 Self-excitation... 74
 Self-inductance... 33
 of armature coils... 268, 295, 300
 Self-induction... 32
 coefficient of... 33, 268, 295, 300
 e.m.f. of... 33
 Separate excitation... 73
 Separately excited generator... 162
 motor... 204
 Series booster... 347
 distribution... 159
 excitation... 74
 generators, characteristics
 75, 168
 in parallel... 186
 motors, applications of... 221
 characteristics... 209
 core loss... 320
 shunt... 184
 windings... 75, 92, 101
 Series-parallel control... 227
 distribution... 159
 windings... 103
 Short-circuit of adjacent coils... 259
 current curves... 238
 demagnetizing effect of... 382
 duration of... 237, 263
 reaction of... 115, 282
 Shunt booster... 348
 excitation... 76
 generators... 76, 173
 in parallel... 187
 motors... 208
 speed regulation... 217
 windings... 76
 Simplex windings... 94
 Simpson's rule... 128
 Sinusoidal commutation... 238, 248

- Slot, leakage flux..... 268
pitch..... 97
shape of..... 64
Slotted armatures..... 120
Smooth core armatures..... 119
Solenoid, field intensity on axis. 17
Sparking constants..... 281
criterion..... 246, 267
Speed characteristics, compound
motor..... 212, 214
separately excited motor. 204
series motor..... 209
shunt motor..... 208
effect of, on separately
excited generator..... 165
on series generator..... 170
on shunt generator..... 177
pulsations, interpole motors 303
regulation, shunt motor... 217
Speed-time curves..... 227
Stability of operation of genera-
tors..... 170
Stand-test, railway motors..... 332
Starting of motors..... 202, 215
rheostats..... 203
Stone train lighting generator.. 361
Storage battery—see Battery
system, straight..... 359
Stow multi-speed motor..... 221
Straight storage system..... 359
Stray power loss..... 317, 318
Surfaces, characteristic—see
Characteristics.
equipotential..... 8
Susceptibility..... 24
Swinburne's commutating de-
vice..... 291
- T
- Teeth, ampere-turns for..... 124
eddy current loss in..... 312
flux density in..... 297
hysteresis loss in..... 308
leakage flux..... 268, 270
shape of..... 64
Temperature, ambient..... 328
- Temperature correction... 328, 329
330, 331
hottest-spot..... 328
rise..... 328, 329, 330,
332, 333, 339, 341
specifications, Electric
Power Club..... 334
time-constant:..... 339
Thermometer, measurement of
resistance by..... 330
Thompson-Ryan winding..... 287
Three-wire generators..... 191
Thury system..... 185, 235
Time constant, temperature rise, 339
Tirrill regulator..... 195
Tooth-tip leakage flux.... 268, 270
Torque..... 199, 202
compound motor..... 212, 214
separately excited motor.. 207
series motor..... 211
shunt motor..... 208
Track return booster..... 348
Tractive effort of electromag-
nets..... 38
Train lighting..... 359
Tubes of force..... 3, 5
Turbo-generators..... 70
Two-circuit windings—see Wave
winding
-layer windings..... 104
- U
- Undercommutation... 239, 243, 256
Uniform magnetic field..... 4
Unipolar generator..... 72
U. S. Lighting & Heating Co.
system of train light-
ing..... 366
- V
- Ventilating ducts..... 63, 344
Volt, definition of..... 15
Voltage commutation..... 240
between commutator seg-
ments..... 61, 295

control of speed..... 218
 limits of batteries.....349, 351
 reactance.....247, 279, 293
 regulation.....161, 360

W

Wagner automobile lighting
 generator.....366, 376
 Ward Leonard system of speed
 control..... 218
 Watt, definition of..... 15
 Wave windings.... 91, 101, 144, 258
 selective commutation in.. 263
 Windage.....314, 320
 Winding, armature..... 88
 chord or fractional pitch
 104, 143, 262, 293
 closed-coil..... 89
 distributed, effect of... 52
 drum..... 89
 dummy..... 102
 element..... 90
 equipotential connections 107
 field displacement..... 98
 step..... 100

lap.....,91, 257, 263
 multiplex..... 94
 number of circuits..... 98
 conductors..... 96
 open-coil..... 89
 parallel..... 92
 pitch of..... 97
 reëtrancy.....94, 103
 resistance.....57, 305
 ring..... 89, 91, 241, 256
 series..... 92
 series-parallel..... 103
 simplex..... 94
 two-layer..... 104
 wave, 91, 101, 144, 258,
 263, 264
 field.....75, 76, 79, 343
 commutating poles..... 298
 Deri..... 289
 Thompson-Ryan..... 287

Y

Yoke, ampere-turns for..... 129
 construction..... 65
 Young and Dunn brush..... 292



UNIVERSITY OF CALIFORNIA LIBRARY

This book is DUE on the last date stamped below.



ICLF (N)

NOV 6 1947

NOV 28 1947

28 Jan 1947

AUG 11 '67 - 1 PM

AUG 8 1967 8 4

LD 21-100m-12,'46(A2012s16)4120

YC 1946I

321575

1/12611

UNIVERSITY OF CALIFORNIA LIBRARY

